

R&S®HMP

Power Supply Family

Up to four channels in a single instrument

3 year warranty



R&S®HMP Power Supply Family At a glance

The R&S®HMP power supplies are primarily designed for industrial use. With two, three or four output channels and up to 10 A output current per channel, these rugged instruments are ideal for a wide variety of applications. They offer high efficiency with low residual ripple and many protection functions.

The R&S®HMP power supply family consists of four models. The R&S®HMP2020 two-channel power supply and the R&S®HMP2030 three-channel power supply deliver up to 188 W total output power, the three-channel R&S®HMP4030 and the four-channel R&S®HMP4040 offer a maximum output power of 384 W. The total load can be distributed as desired over the separate channels. Depending on the model, up to 80 W or 160 W of channel power is available – in any voltage/current distribution.

Up to four galvanically isolated, floating output channels with overload and short-circuit protection are available, depending on the instrument type. The channels can be connected in series or parallel to obtain higher voltages or currents. The R&S®HMP4040, for example, offers a maximum voltage of 128 V or a maximum current of 40 A.

All basic functions of the R&S®HMP power supplies are directly accessible on the front panel. The rotary knob plays a key role. It is used to set the voltage, current and limit values for the various protection functions.

The channel keys light up in different colors to indicate the operating conditions of the channels. All channels can be simultaneously switched on or off with the “Output” key, which lights up white when it is “on”. Active outputs light up green in constant voltage mode and red in constant current mode.

The R&S®HMP power supplies offer a variety of protection functions to prevent damage to the instrument and the DUT. You can separately set the maximum current (electronic fuse, overcurrent protection/OCP) or the maximum voltage (overvoltage protection/OVP) for each channel. The output channels switch off when either of their set limits is reached. Overtemperature protection (OTP) prevents the instrument from overheating.

In industrial applications, power supplies are often installed in 19-inch racks. The R&S®HZ42 and R&S®HQP91 rack adapters are available for this purpose. Additional connections for all channels (including sense lines) are provided on the rear panel to simplify use in system cabinets.

The R&S®HMP power supplies are equipped with a dual USB/LAN interface as standard. This interface can optionally be replaced by a dual RS-232/USB interface or a GPIB (IEEE488) interface.

Key facts

- R&S®HMP2020/HMP2030 with 2/3 channels and 188 W total output power
- R&S®HMP4030/HMP4040 with 3/4 channels and 384 W total output power
- Maximum output voltage of 32 V per channel; higher voltages possible in serial operation
- High output currents up to 5 A/10 A (depending on the model); higher currents possible in parallel operation
- Linear postregulation for low residual ripple
- Electronic fuse (OCP), adjustable maximum voltage (OVP), overtemperature protection (OTP)
- Dual USB/LAN interface as standard; RS-232/USB or GPIB (IEEE488) optional
- Rear panel connections, including sense lines, for all channels

Model overview	R&S®HMP2020	R&S®HMP2030	R&S®HMP4030	R&S®HMP4040
Number of output channels	2	3	3	4
Max. output current per channel	channel 1: 10 A channel 2: 5 A	5 A	10 A	10 A
Max. output power per channel	channel 1: 160 W channel 2: 80 W	80 W	160 W	160 W
Total output power	max. 188 W	max. 188 W	max. 384 W	max. 384 W
Output voltage per channel	0 V to 32 V	0 V to 32 V	0 V to 32 V	0 V to 32 V

R&S®HMP Power Supply Family

Benefits and key features

More than meets your daily needs

- ▮ All channels galvanically isolated and floating
- ▮ All channels have the same voltage range
- ▮ All channels have overload and short-circuit protection
- ▮ Parallel and serial operation
- ▮ Constant voltage and constant current modes
- ▮ Tracking and link functions
- ▮ Protection functions to safeguard instrument and DUT
- ▮ Modern instrument concept: small, compact and quiet

Easy operation

- ▮ Intuitive to use
- ▮ Color coding of operating states
- ▮ EasyArb function for all channels
- ▮ Save and recall instrument settings

Ideal for labs and test systems

- ▮ Tailored for use in labs and system racks
- ▮ Sense function for more stringent accuracy requirements
- ▮ Remote control of instrument functions

Different power supply classes



Basic power supplies

- ▮ Affordable, quiet and stable instruments
- ▮ For manual operation and simple computer-controlled operation
- ▮ Used in education, on the bench and in system racks

Shown here: [R&S®NGE103 power supply](#).

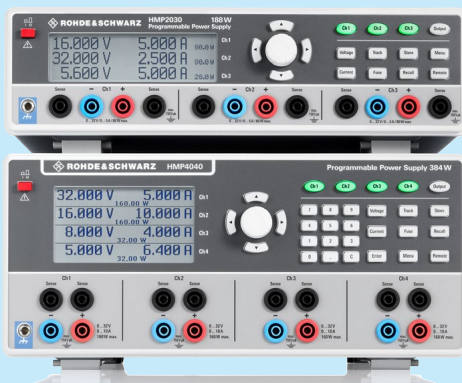

Performance power supplies

- ▮ When speed, accuracy and advanced programming features are factors in test performance
- ▮ Features such as DUT protection, fast programming times and downloadable V and I sequences
- ▮ Used in labs and ATE applications

Shown here: [R&S®HMP2030 three-channel power supply](#) and [R&S®HMP4040 four-channel power supply](#).



Specialty power supplies

- ▮ Tailored to specific applications
- ▮ Unique capabilities such as
 - Emulation of the unique characteristics of a battery
 - Electronic loads to accurately sink current and dissipate power in a controlled manner
- ▮ Used in labs and ATE environments

Shown here: [R&S®HM8143 three-channel arbitrary power supply](#).

More than meets your daily needs

All channels galvanically isolated and floating

The R&S®HMP power supply family consists of instruments with two, three or four channels. The circuitry of each single channel is completely isolated from the others; there is no connection to chassis ground. This makes it easy to combine the channels to drive balanced circuitries that might need +12 V/-12 V, for example, and avoids any ground problems in complex DUTs.

Supplying balanced circuits

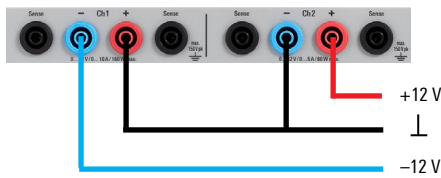

Two channels can be connected together to supply balanced circuits with e.g. +12 V/-12 V.

All channels have the same voltage range

In contrast to other power supplies on the market, the R&S®HMP power supplies offer the same voltage range on all channels. You can select any channel for a specific application. Each channel can be regarded as a separate power supply. Four models in two power classes are available, with two, three or four output channels.

All channels have overload and short-circuit protection

Even the most experienced user is occasionally distracted – so it's good to know that since the outputs are protected against overloads and short circuits, the R&S®HMP power supplies will not be damaged.

Parallel and serial operation

Because all channels are electrically equivalent, they can be combined in serial mode to achieve higher voltages. Up to 128 V can be achieved with the R&S®HMP4040.

In parallel mode, the channels can be bundled for higher current. Up to 20 A can be achieved when two channels are combined, and up to 40 A when all four channels of the R&S®HMP4040 are combined.

Constant voltage and constant current modes

Configuring and regulating the output voltage (constant voltage mode) is the standard application for power supplies. However, the R&S®HMP power supplies can also be used in constant current mode, with each channel separately configurable. If the configured current level is exceeded, current limiting ensures that only the configured current can flow. The output voltage is accordingly reduced below the configured value. This prevents damage to the test circuit in the event of a fault.

Tracking and link functions

The separate output channels can be used as independent power sources, but their true versatility becomes evident when combined. The channels can be connected in parallel to achieve higher currents or in series for higher voltages. The convenient tracking function lets you vary the voltage on all channels in parallel. The link function for the electronic fuses makes the instrument even more versatile. The power supply can be configured to switch off all channels when any one of the channels reaches its limit value. It can also be configured so that certain channels remain active, for example to power the fan that cools the DUT. The status of the fuses and all other protection functions are always shown on the display.

R&S®HMP2020 two-channel instrument.



R&S®HMP2030 three-channel instrument.

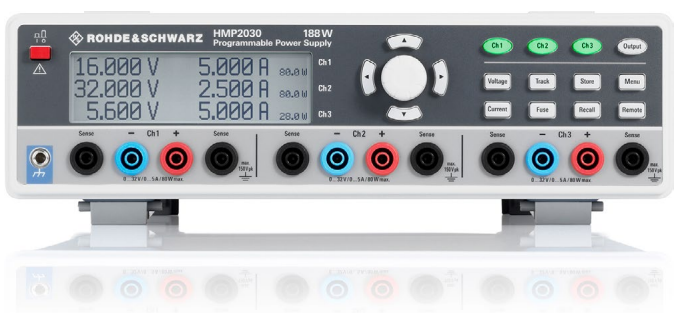

Parallel and serial operation

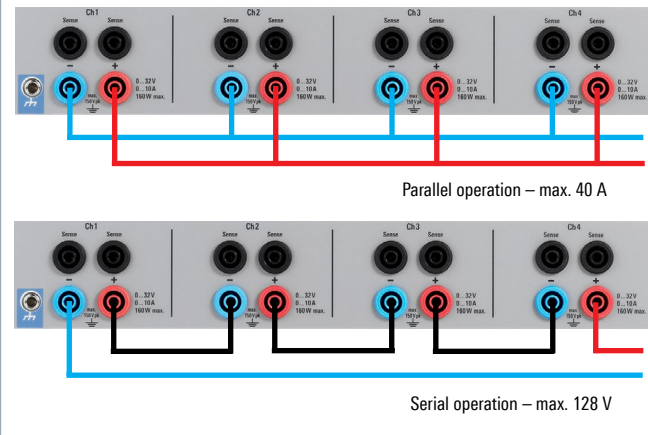

The output channels can be configured in parallel to achieve higher output current, or in series for higher output voltage.

Protection functions to safeguard instrument and DUT

Protection functions are common in performance power supplies with their high output power. But they are not always implemented as consistently as in the R&S[®]HMP power supply family. For example, the limit values for all protection functions can be configured separately for each channel.

Maximum voltage (overvoltage protection, OVP)

If the voltage rises above the configured maximum value, the output is switched off and the “OVP” indicator on the display blinks. Depending on the setting, the voltage configured on the instrument or the voltage measured by the instrument is used as the switching threshold for OVP.

Maximum current (electronic fuse, overcurrent protection, OCP)

To provide even better protection for sensitive loads, each channel of the R&S[®]HMP power supplies is equipped with an electronic fuse that can be separately configured or

cleared. If a configured current level is exceeded, the affected output channel will be automatically switched off and a message will be displayed.

The electronic fuse can be linked to other channels (Fuse-Link function). If a channel exceeds the maximum current level, then this channel and all linked channels will be switched off. Even the delay time of the electronic fuses can be set. With this functionality, you can adjust the behavior of the power supply so that short current spikes that occur when a channel is switched on do not trip the electronic fuse.

Overtemperature protection (OTP)

Of course the R&S[®]HMP power supplies have internal overtemperature protection that switches off the instrument if there is an imminent risk of thermal overload.

Modern instrument concept: small, compact and quiet

Universal power supplies need to fulfill a variety of requirements. For instance, they must work reliably in countries with unstable power grids. The primary transformer in the R&S[®]HMP acts as a lowpass filter to maintain stable operation.

Power supplies should be small and compact. The secondary switching regulator makes the R&S[®]HMP extremely efficient. It reduces weight and size, and the regulated fan usually runs at low speed or shuts off completely, which results in low noise.

Power supplies should provide stable output voltages/currents with low ripple. This is realized by using linear control circuitry for stabilization.

R&S[®]HMP4030 three-channel instrument.



R&S[®]HMP4040 four-channel instrument.

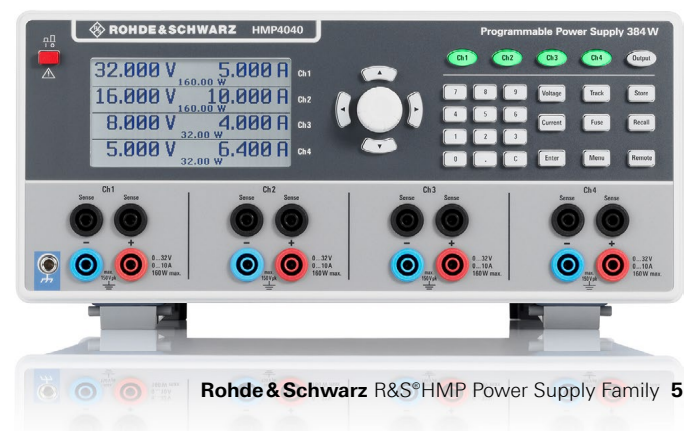

Easy operation

Intuitive to use

All basic R&S®HMP power supply functions can be operated directly via keys on the front panel. It is only necessary to use the menu level for special functions that are needed less frequently.

Simply press the “Voltage” key, select an output channel and use the rotary knob or arrow keys to adjust the output voltage in steps as small as 1 mV. You can similarly set a constant output current with a resolution as fine as 0.1 mA, depending on the model and the current range. On the R&S®HMP4030/HMP4040 instruments, you can also use the numeric keypad to enter values. If you need to set several channels at the same time, for example to increase the output voltage from ± 12 V to ± 15 V, simply press the “Track” key and select the two channels for the positive and negative voltages. Now you can use the rotary knob to symmetrically adjust the two voltages. Activating and deactivating the electronic fuses is just as easy – simply press the “Fuse” key and the channel key.

Color coding of operating states

All settings and operating conditions, including the output power and the status of the protection functions, are shown on the display and indicated by the colors of the illuminated channel keys. The colors of the illuminated keys indicate the different operating conditions:

- Active channel in constant voltage mode: green
- Active channel in constant current mode: red
- Channel in setting mode: blue

The “Output” key lights up white when the selected output channels are connected to the load.

EasyArb function for all channels

Some applications require you to vary the voltage or the current during a test sequence, for example to simulate different charging conditions of a battery. The EasyArb function provides a convenient solution. It lets you program time/voltage or time/current sequences, either manually via the user interface, or via the external interfaces.

EasyArb can be used for separate channels or for all channels. Up to three complete arbitrary curves with up to 128 points can be saved in the internal memory and retrieved when needed.

Save and recall instrument settings

Frequently used settings can be saved and retrieved using the “Store” and “Recall” keys.

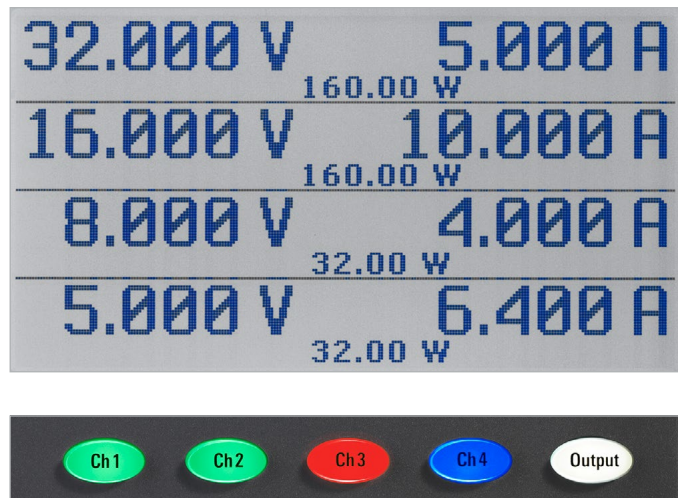

All settings and operating states are clearly visualized. Constant voltage mode is indicated by a green key, constant current mode is indicated by a red key. The key color changes to blue in setting mode.

Ideal for labs and test systems

Tailored for use in labs and system racks

Performance power supplies are designed for higher output power than standard instruments. They must be stable and at the same time provide the required accuracy and speed, regardless of whether they are used on the lab bench or integrated into a production test system.

Remote control functions and rack adapters are essential in system applications. Access to rear panel connections, and above all compact design, are key factors for use in test systems.

The R&S®HMP power supplies fulfill all these requirements – in particular the R&S®HMP4040, which uniquely combines four electronically equivalent high-performance channels in a compact package.

Sense function for more stringent accuracy requirements

There is often a significant voltage drop over the connection leads, especially in applications with high current consumption. Since power supplies usually maintain a constant output voltage, the voltage on the DUT will be lower than the voltage displayed on the instrument. The sense function compensates for this voltage drop over the supply leads. The voltage actually present at the load is measured by an additional pair of sense lines, and this value is used to regulate the voltage directly at the load. The R&S®HMP power supplies provide separate sense lines for each output channel.

Connections on front and rear panels

The safety sockets on the front panel of the R&S®HMP power supplies are designed for 4 mm banana plugs. Additional connections for all channels (including sense lines) are provided on the rear panel to simplify use in rack systems.

Connections for all channels – including sense lines – are also provided on the rear panel (shown here: R&S®HMP4040).

Remote control of instrument functions

All instruments in the R&S®HMP family can be remotely controlled for use in test systems. The Standard Commands for Programmable Instruments (SCPI) scripting language is used. The following interfaces are available:

Dual interface USB/LAN:

The R&S®HO732 dual interface with ports for USB and LAN is installed as standard.



Dual interface RS-232/USB:

The R&S®HO720 dual interface with ports for RS-232 and USB is available as an option. This interface option can be installed instead of the standard R&S®HO732 interface.

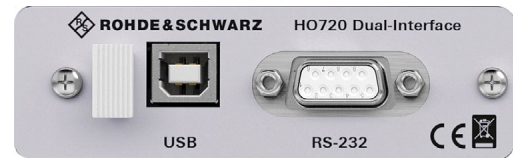

GPIB interface:

The R&S®HO740 interface with a GPIB (IEEE488) port is also available as an option. It can also be installed instead of the standard R&S®HO732 interface.

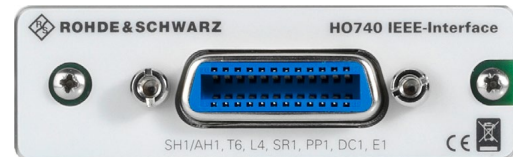

You can implement other remote control interfaces yourself, without opening the power supply enclosure.



Specifications

All data is valid at 23°C (–3°C/+7°C) after 30 minutes warm-up time.

Electrical specifications		
Outputs	All channel outputs are galvanically isolated and not connected to ground.	
Number of output channels	R&S®HMP2020	2
	R&S®HMP2030	3
	R&S®HMP4030	3
	R&S®HMP4040	4
Total output power	R&S®HMP2020/HMP2030	max. 188 W
	R&S®HMP4030/HMP4040	max. 384 W
Maximum output power per channel	R&S®HMP2020	channel 1: 160 W; channel 2: 80 W
	R&S®HMP2030	80 W
	R&S®HMP4030/HMP4040	160 W
Output voltage per channel	all models	0 V to 32 V
Maximum output current per channel	R&S®HMP2020	channel 1: 10 A; channel 2: 5 A
	R&S®HMP2030	5 A
	R&S®HMP4030/HMP4040	10 A
Maximum voltage in serial operation	R&S®HMP2020	64 V
	R&S®HMP2030/HMP4030	96 V
	R&S®HMP4040	128 V
Maximum current in parallel operation	R&S®HMP2020/HMP2030	15 A
	R&S®HMP4030	30 A
	R&S®HMP4040	40 A
Voltage ripple	3 Hz to 100 kHz	< 250 µV (RMS), typ. <150 µV (RMS)
	3 Hz to 20 MHz	typ. < 1.5 mV (RMS)
Current ripple		< 1 mA (RMS)
Load regulation	load change from 10% to 90%	
Voltage	±(% of output + offset)	< 0.01 % + 2 mV
Current	±(% of output + offset)	< 0.01 % + 250 µA
Load recovery time	to within ± 10 mV of the set nominal voltage	< 1 ms
Line regulation	±10% change in mains voltage	
Voltage	±(% of output + offset)	< 0.01 % + 2 mV
Current	±(% of output + offset)	< 0.01 % + 250 µA
Programming resolution		
Voltage		1 mV
Current	R&S®HMP2020 channel 1 (10 A)	< 1 A: 0.2 mA; ≥ 1 A: 1 mA
	R&S®HMP2020 channel 2 (5 A)	< 1 A: 0.1 mA; ≥ 1 A: 1 mA
	R&S®HMP2030	< 1 A: 0.1 mA; ≥ 1 A: 1 mA
	R&S®HMP4030/HMP4040	< 1 A: 0.2 mA; ≥ 1 A: 1 mA
Programming accuracy		
Voltage	±(% of output + offset)	< 0.05 % + 5 mV
Current	±(% of output + offset)	< 0.1 % + 5 mA

Output measurements		
Measurement functions		voltage, current
Readback resolution		
Voltage		1 mV
Current	R&S®HMP2020 channel 1 (10 A)	< 1 A: 0.2 mA; ≥ 1 A: 1 mA
	R&S®HMP2020 channel 2 (5 A)	< 1 A: 0.1 mA; ≥ 1 A: 1 mA
	R&S®HMP2030	< 1 A: 0.1 mA; ≥ 1 A: 1 mA
	R&S®HMP4030/HMP4040	< 1 A: 0.2 mA; ≥ 1 A: 1 mA
Readback accuracy		
Voltage	±(% of output + offset)	< 0.05 % + 5 mV
Current	±(% of output + offset)	< 0.1 % + 2 mA

Output measurements

Temperature coefficient (per °C)	5 °C to 20 °C and 30 °C to 40 °C	
Voltage	±(% of output + offset)	0.01 % + 2 mV
Current	±(% of output + offset)	0.02 % + 3 mA
Sense function		yes, for each channel
Maximum sense compensation		1 V

Ratings

Maximum voltage to earth		150 V (peak)
Maximum counter-voltage	voltage with same polarity connected to the outputs	33 V
Maximum reverse voltage	voltage with opposite polarity connected to the outputs	0.4 V
Maximum reverse current	for 5 minutes max.	5 A

Remote control mode

Command processing time		< 50 ms
-------------------------	--	---------

Protection functions

Overvoltage protection		configurable for each channel
Overcurrent protection (electronic fuse)		configurable for each channel
Response time	$(I_{load} > I_{response} \times 2)$	< 10 ms
Fuse linking (FuseLink function)		yes
Fuse delay time	configurable for each channel	0 ms to 250 ms (10 ms increments)
Overtemperature protection		yes

Special functions

Arbitrary function (EasyArb)		
Parameter		voltage, current, time
Maximum number of points		128
Dwell time		10 ms to 60 s
Repetition		continuous or burst mode 1 to 255 repetitions
Data memory		non-volatile memory for three arbitrary functions and ten instrument settings

Display and interfaces

Display	R&S®HMP2020/HMP2030	240 pixel × 64 pixel LCD
	R&S®HMP4030/HMP4040	240 pixel × 128 pixel LCD
Front panel connections	channel outputs	4 mm safety sockets
Rear panel connections		connector block with 4 lines per channel
Remote control interfaces	standard	dual interface LAN/USB
	optional	dual interface USB/RS-232 (R&S®HO720)
	optional	IEEE488 (GPIB) (R&S®HO740)

General data

Environmental conditions

Temperature	operating temperature range	+5 °C to +40 °C
	storage temperature range	-20 °C to +70 °C
Humidity	noncondensing	5% to 80%

Power rating

Mains nominal voltage		115 V/230 V (±10%); CAT II
Mains frequency		50 Hz to 60 Hz
Maximum power consumption	R&S®HMP2020/HMP2030	300 W
	R&S®HMP4030/HMP4040	600 W
Mains fuses (115 V power source)	R&S®HMP2020/HMP2030	2 × T6.3H/250 V
	R&S®HMP4030/HMP4040	2 × T10H/250 V
Mains fuses (230 V power source)	R&S®HMP2020/HMP2030	2 × T3.15H/250 V
	R&S®HMP4030/HMP4040	2 × T5H/250 V

Product conformity

Electromagnetic compatibility	EU: in line with EU EMC Directive 2014/30/EU in line with EU EMC Directive 2014/53/EU Korea	applied harmonized standards: <ul style="list-style-type: none"> ■ EN 61326-1: 2013 ■ EN 61326-2-1: 2013 ■ EN 55011: 2016 (Class A) ■ IEC 61000-3-2 2014 (Class B) ■ IEC 61000-3-3: 2013 ■ EN 50581:2012 (RoHS) ■ EN 300 328 V2.1.1 ■ KN 61000-4-11: 2008
Electrical safety	EU: in line with Low Voltage Directive 2006/95/EC USA, Canada	applied harmonized standards: EN 61010-1:2010 CSA C22.2 No. 61010-1:2012

Mechanical resistance

Vibration	sinusoidal	5 Hz to 55 Hz, 0.3 mm amplitude const., 55 Hz to 155 Hz, 0.5 g const., in line with EN 60068-2-6: 2008
	random	8 Hz to 500 Hz, 1.2 g (RMS), in all 3 axes, in line with EN 60068-2-64: 2008

Mechanical data

Dimensions (W × H × D)	R&S®HMP2020/HMP2030	285 mm × 95 mm × 405 mm (11.22 in × 3.74 in × 15.94 in)
	R&S®HMP4030/HMP4040	285 mm × 136 mm × 405 mm (11.22 in × 5.35 in × 15.94 in)
Weight	R&S®HMP2020	7.8 kg (17.2 lb)
	R&S®HMP2030	8.0 kg (17.6 lb)
	R&S®HMP4030	12.4 kg (27.3 lb)
	R&S®HMP4040	12.8 kg (28.2 lb)
Rack installation	R&S®HMP2020/HMP2030	R&S®HZ42 option
	R&S®HMP4030/HMP4040	R&S®HWP91 option

Recommended calibration interval

	operation 40 h/week over entire range of specified environmental conditions	1 year
--	---	--------

Ordering information

Designation	Type	Order No.
Base unit		
Two-Channel Power Supply	R&S®HMP2020	3629.6718.02
Three-Channel Power Supply	R&S®HMP2030	3629.6718.03
Three-Channel Power Supply	R&S®HMP4030	3629.6776.03
Four-Channel Power Supply	R&S®HMP4040	3629.6776.04
Included accessories		
Set of power cables, quick start guide		
Interface options		
Dual Interface (RS-232/USB)	R&S®HO720	3594.3660.02
IEEE488 (GPIB) Interface	R&S®HO740	3622.3194.02
System components		
19" Rack Adapter, 2 HU for R&S®HMP2020/HMP2030	R&S®HZ42	3622.3207.02
19" Rack Adapter, 4 HU for R&S®HMP4030/HMP4040	R&S®HZIP91	5800.0939.02

Warranty		
Base unit		3 years
All other items ¹		1 year
Options		
Extended Warranty, one year	R&S®WE1	Please contact your local Rohde & Schwarz sales office.
Extended Warranty, two years	R&S®WE2	
Extended Warranty with Calibration Coverage, one year	R&S®CW1	
Extended Warranty with Calibration Coverage, two years	R&S®CW2	

¹ For options that are installed, the remaining base unit warranty applies if longer than 1 year. Batteries are generally covered by a 1 year warranty.

Service that adds value

- | Worldwide
- | Local and personalized
- | Customized and flexible
- | Uncompromising quality
- | Long-term dependability

Rohde & Schwarz

The Rohde & Schwarz electronics group offers innovative solutions in the following business fields: test and measurement, broadcast and media, secure communications, cybersecurity, monitoring and network testing. Founded more than 80 years ago, the independent company which is headquartered in Munich, Germany, has an extensive sales and service network with locations in more than 70 countries.

Sustainable product design

- | Environmental compatibility and eco-footprint
- | Energy efficiency and low emissions
- | Longevity and optimized total cost of ownership

Certified Quality Management

ISO 9001

Certified Environmental Management

ISO 14001

testoon.COM
The measurement website

99 rue Beranger - 92320 Chatillon - France
Tel. : +33 (0) 1 71 16 17 00 - Fax : +33 (0) 1 71 16 17 03
www.testoon.com

Rohde & Schwarz GmbH & Co. KG

www.rohde-schwarz.com

Rohde & Schwarz training

www.training.rohde-schwarz.com

Regional contact

- | Europe, Africa, Middle East | +49 89 4129 12345
customersupport@rohde-schwarz.com
- | North America | 1 888 TEST RSA (1 888 837 87 72)
customer.support@rsa.rohde-schwarz.com
- | Latin America | +1 410 910 79 88
customersupport.la@rohde-schwarz.com
- | Asia Pacific | +65 65 13 04 88
customersupport.asia@rohde-schwarz.com
- | China | +86 800 810 82 28 | +86 400 650 58 96
customersupport.china@rohde-schwarz.com

R&S® is a registered trademark of Rohde & Schwarz GmbH & Co. KG
Trade names are trademarks of the owners
PD 5215.4981.12 | Version 01.01 | Januar 2018 (GK)
R&S®HMP Power Supply Family
Data without tolerance limits is not binding | Subject to change
© 2018 Rohde & Schwarz GmbH & Co. KG | 81671 Munich, Germany



5215498112