

PicoVNA[®] 106

6 GHz vector network analyzer

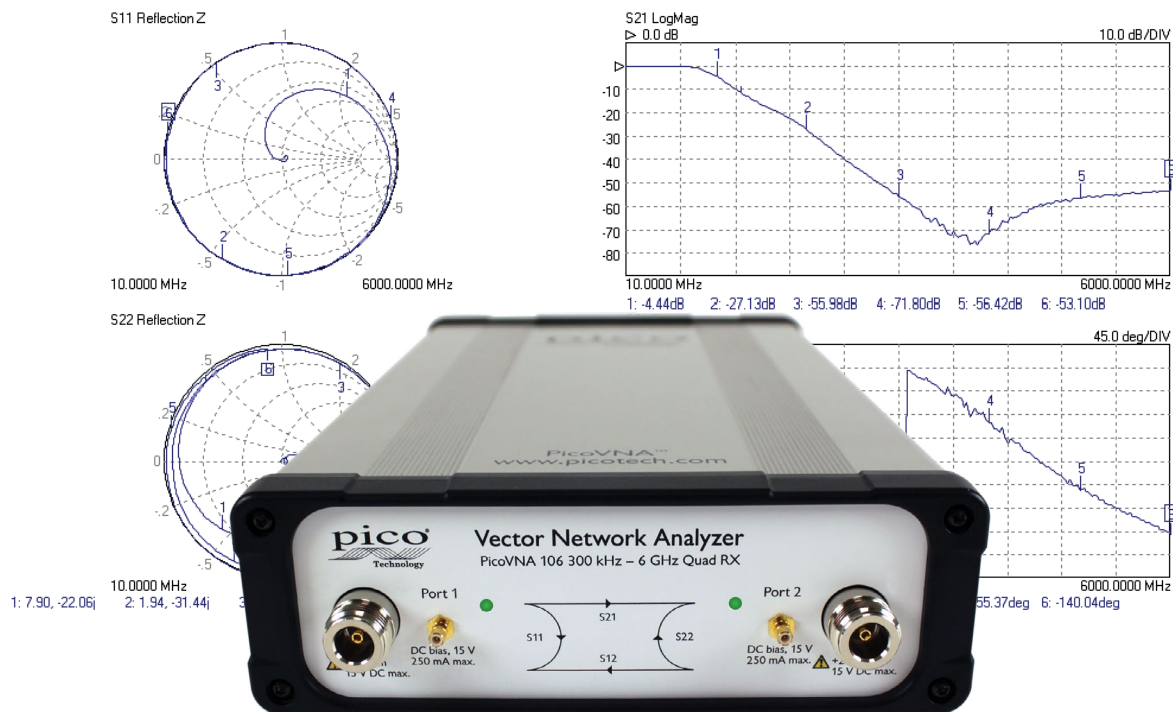

Professional and portable performance at low cost

- 300 kHz to 6 GHz operation
- High speed of > 5000 dual port S-parameters per second
- Quad RX four-receiver architecture for best accuracy
- 118 dB dynamic range at 10 Hz bandwidth
- 0.005 dB RMS trace noise at maximum bandwidth of 140 kHz
- Half-rack, small-footprint, lightweight package

- PC-controlled over USB from a Microsoft Windows interface
- Reference plane offsetting and de-embedding
- Time domain and port impedance transformations
- Tabular and graphic print and save formats, including Touchstone P1dB, AM to PM, and stand-alone signal generator utilities

- Fully accessible, guided 8 and 12-term calibration processes
- 6 calibration modes, including unknown through and connected DUT isolation
- Calibration and check standards with data guarantee confident measurements

Vector network analysis for the many

Once the domain of an elite few, microwave measurement has encroached into the lives of scientists, educators, surveyors, inspectors, engineers and technicians alike. Today's microwave measurements need to be straightforward, portable, accurate, cost-effective and easy to learn.

The PicoVNA 106 is an all new, UK-designed, professional USB-controlled, laboratory grade vector network instrument of unprecedented performance, portability and value for money. Despite its simple outline, small footprint and low cost, the instrument boasts a four-receiver architecture to minimize the uncorrectable errors, delays and unreliability of internal transfer switches.

Despite its small size, the PicoVNA 106 delivers an exceptional dynamic range of 118 dB at 10 Hz and only 0.005 dB RMS trace noise at its maximum operating bandwidth of 140 kHz. It can also gather all four S-parameters at every frequency point in just 190 μ s; in other words, a 500 point 2-port .s2p Touchstone file in less than a tenth of a second. Its low price means that the PicoVNA 106 would be cost-effective as a deep dynamic range scalar network analyzer or a single-port vector reflectometer. However, despite its size and price, the PicoVNA 106 really is a full-function dual-port, dual-path vector network analyzer. It's affordable in the classroom, in small businesses and even in amateur workshops, yet capable of meeting the needs of all users up to the microwave laboratory technician and expert.



Vector network analysis everywhere

The PicoVNA's small size, weight and cost, and high performance suit it to field service, installation test, embedded and classroom applications. With its remote automation capability, it's also attractive in applications such as:

- Test automation, including multiple VNA control and measurement
- Manufacturers needing to integrate a reflectometry or transmission measurement core
- Inspection, test, characterization and calibration in the manufacture, distribution and service center industries
 - Electronics component, assembly and system, and interface/interconnect ATE (cable, PCB and wireless)
 - Material, geological, life science and food sciences; tissue imaging; penetrating scan and radar
- Broadband cable and harness test and matching at manufacture and installation, and fault-over-life monitoring
- Antenna matching and tuning

Software development kits, including code examples in MATLAB and MATLAB RF toolbox, LabVIEW, C, C# and Python, are available for download from Pico Technology's GitHub pages. Examples include multiple instrument addressing and control.

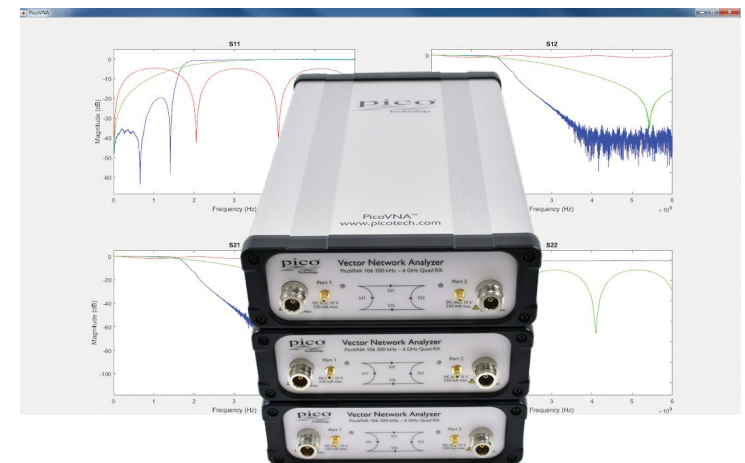

Quad RX four-receiver architecture

In a VNA a swept sine-wave signal source is used to sequentially stimulate the ports of the interconnect or device under test. The amplitude and phase of the resultant transmitted and reflected signals appearing at both VNA ports are then received and measured. To wholly characterize a 2-port device under test (DUT), six pairs of vector measurements are needed: the amplitude and phase of the signals that were emitted from both ports, and the amplitude and phase of the signals that were received at both ports for each source. In practice this can be achieved with a degree of accuracy with a single source, a transfer switch and two receivers; the latter inputs being switched through a further pair of transfer switches. Alternatively three receivers can be used with an additional input transfer switch or, as in the PicoVNA, four receivers can be used. Using four receivers eliminates the receiver input transfer switch errors (chiefly leakage and crosstalk) that cannot be corrected. These residual errors are always present in two- and three-receiver architectures and lead to lower accuracy than that of the *Quad RX* design.

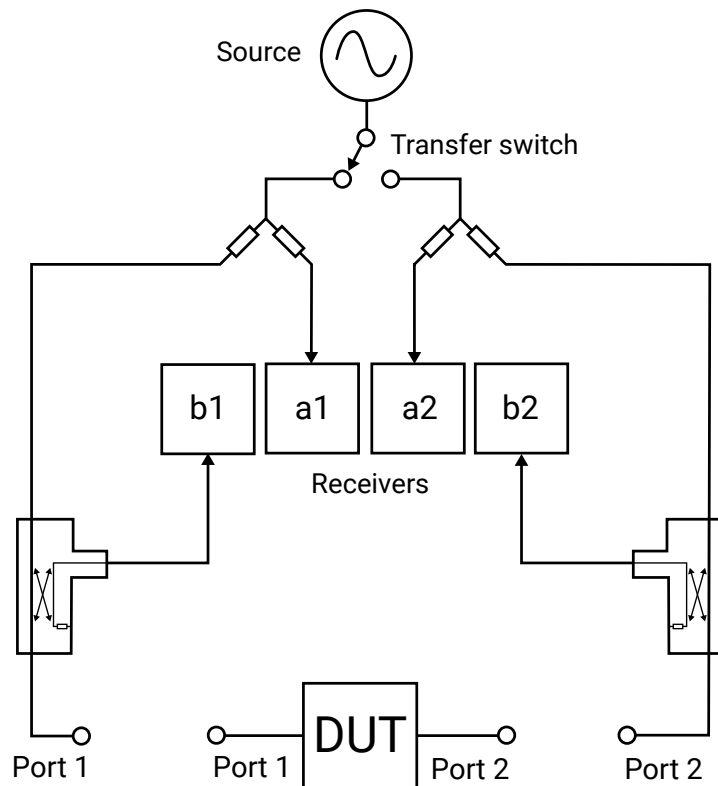

Support for 8 and 12-term calibration and the *unknown through*

Almost all vector network analyzers are calibrated for twelve error sources (six for each signal direction). This is the so-called *12-term calibration*, which experienced VNA users are used to performing fairly regularly. In a four-receiver design some error sources are so reduced that *8-term calibration* becomes possible, along with an important and efficient calibration technique known as the *unknown through*. This gives the ability to use any *through* interconnect (including the DUT) during the calibration process, vastly simplifying the procedure and reducing the number of costly calibration standards that need to be maintained. Advanced vector network analyzer users will be pleased to know that internal a-wave and b-wave data can be exported for diagnostic use.

Bias-Ts

Bias-Ts are often not provided, or available as costly extras, on other VNAs. Use the PicoVNA 106's built-in bias-Ts to provide a DC bias or test stimulus to active devices without the complexity and cost of external DC-blocks. The bias is supplied from external power supplies or test sources routed to the SMB connectors adjacent to each VNA port.

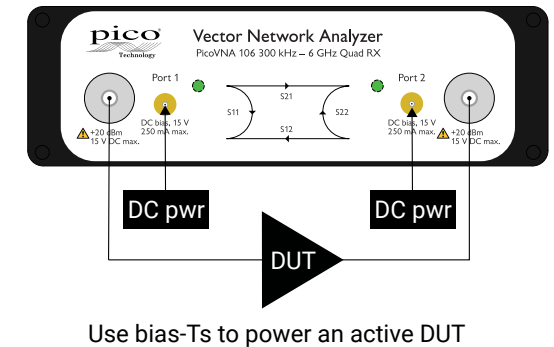

Other I/O

Power (12 to 15 V DC @ 22 W) and USB 2.0 control are located on the rear panel. Trigger I/O for sweep synchronization and 10 MHz I/O for reference clock synchronization are available on four BNC sockets.

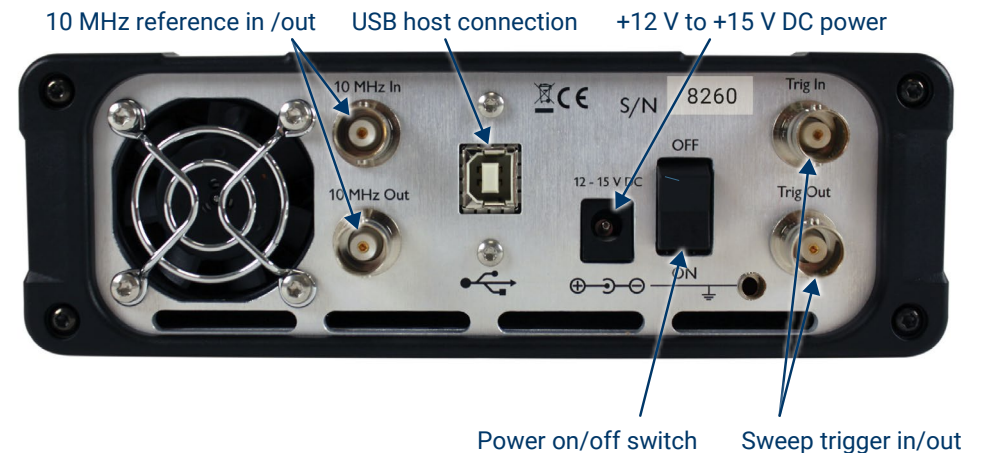

Test cables, adaptors, calibration standards and measurement check standards

A range of high-integrity RF and Microwave accessories are available from Pico Technology. Test cables and calibration standards have particular significance to the overall performance of a VNA, so we recommend that you select your accessories and perform your calibrations carefully.







Cables and standards are often the weakest links in a VNA measurement, generally contributing significantly to measurement uncertainty despite their traditionally high cost. At the lowest levels of uncertainty, costs can be significant and measurements can be compromised by seemingly quite minor damage or wear. For these reasons, many customers hold both premium-grade items for calibration, reference or measurement standards, and standard-grade items as working standards and cables. Pico Technology now offers cost-effective solutions in both grades. In general we recommend PC3.5 interfaces for premium or reference use and SMA interfaces for working use

Phase- and amplitude-stable test leads

Two test cable types and grades are recommended and provided by Pico Technology. Both of high quality, with robust and flexible construction and stainless steel connectors, the main differences between them are the provision of PC3.5 or SMA test ports and the stability of their propagation velocity and loss characteristic when flexed; that is, the degree to which a measurement could change when the cables are moved or formed to a new position. Cables are specified in terms of flatness and phase variation at up to 6 GHz when a straight cable is formed as one 360° turn around a 10 cm mandrel.





Order code	Grade	Connectors	Dielectric	Ø over jacket	Impedance (Ω)	Loss (dB) @ 6 GHz	Phase stability @ 6 GHz	Amplitude stability (dB) @ 6 GHz	Length (mm)
TA336	Standard	N(m)–SMA(m)	Low-density PTFE	7.1 mm (0.28")	50	0.7	2°	0.1	600
TA337		N(m)–SMA(f)							
TA338	Premium	N(m)–PC3.5(m)		7.5 mm (0.30")		0.6	0.8°	0.05	
TA339	N(m)–PC3.5(f)								

Test port adaptors

Order code	Name	Grade	Impedance (Ω)	Bandwidth (GHz)	Connector type*
TA342	 ADA-STD-MM	Standard	50	18	SMA(m-m)
TA343	 ADA-STD-FF				SMA(f-f)
TA357	 ADA-STD-FM				SMA(f-m)
TA340	 ADA-PREM-MM	Premium	50	27	PC3.5(m-m)
TA341	 ADA-PREM-FF				PC3.5(f-f)
TA354	 ADA-PREM-FM				PC3.5(f-m)

Calibration and measurement reference standards

Pico Technology also offers two short, open, load and through (SOLT), 4-piece, 5-port calibration kits in both male and female genders. All kits have high-performance tight-tolerance stainless steel interface connectors. Kits are supplied as an assembled five-port "Y" SOLT, either male or female. They can be disassembled for individual usage, or for economical refurbishment should a calibration standard be damaged. Each SOLT is supplied with calibration data linked to the kit serial number and is supplied in a protective carry case. Both the Standard and Premium kits offer exceptional residual directivity for the price. It is this that combines with good uncorrected port match on the PicoVNA 106 to deliver exceptional price-performance. Premium PC3.5 kits are calibrated to reduced uncertainty using TRL (through, reflect, line) intercomparison above 1.5 GHz. All kits are calibrated against fully traceable PC3.5 standards. Further specifications for the instrument and calibration kits can be found on later pages. We also offer a calibration service for Pico standards only – see [Ordering information](#).

Order code	Name	Grade	Ports	Impedance (Ω)	Bandwidth (GHz)	Connector type*
TA344	 SOLT-STD-M	Standard	5: short, open, load, through	50	6	SMA(m)
TA345	 SOLT-STD-F					SMA(f)
TA346	 SOLT-PREM-M	Premium	5: short, open, load, through	50	6	PC3.5(m)
TA347	 SOLT-PREM-F					PC3.5(f)

* SMA, PC3.5 and K-type/2.92 connectors can all be mated with each other. SMA type has solid dielectric, PC3.5 has air dielectric.

Test cables and calibration standards selection guide

Calibration kits can be purchased as a pair or as a single kit depending on the primary (best uncertainty) measurement application and its DUT interface, and sometimes to meet a secondary purpose with other DUT interfaces. Budget may also be a consideration. Pico Technology provides for all purchase options. You can order any combination of accessories, but to get you started we recommend that you choose one of the following standard configurations.

Recommended 'universal' configuration

For best overall test efficiency and uncertainty in a mix of single-port or dual-port test applications of both genders, we recommend this dual-port, insertable test lead and calibration standards configuration and the use of additional test port adaptors as necessary. All calibration modes are then available and where needed port adaptors can be fully included in the calibration.

Primary DUT interface	Accessory grade	Test leads required	Calibration kits required	Supported measurement and calibration modes	Suited to DUTs...
Dual-port insertable with a male and a female port	Choose: Standard SMA	1x male + 1x female: TA336 + TA337	1x male + 1x female: TA344 + TA345	All S-parameters and calibration modes	Insertable dual-port devices and any single-port male or female device.
	Premium PC3.5	TA338 + TA339	TA346 + TA347		Use and fully calibrate port adaptors for dual-port single-gender noninsertable devices.

Single-gender port configurations

The following configurations are recommended where there is a focus on a particular port gender, single-port DUT or noninsertable' dual-port DUTs of a single gender.

Primary DUT interface	Accessory grade	Test leads required	Calibration kits required	Supported measurement and calibration modes	Suited to DUTs...
Single port or dual-port noninsertable with female port(s)	Choose: Standard SMA	2x male* TA336	1x female: TA345	All S-parameters and all calibration modes except insertable	Noninsertable dual female port devices and single female port devices.
	Premium PC3.5	TA338	TA347		Use port adaptors for male port devices, separately measured and de-embedded**.
Single port or dual-port noninsertable with male port(s)	Choose: Standard SMA	2x female* TA337	1x male: TA344		Noninsertable dual male port devices and single male port devices.
	Premium PC3.5	TA339	TA346		Use port adaptors for female port devices, separately measured and de-embedded**.

* Can reduce to a single test lead in single-port measurement applications.

** With only one calibration kit it is not possible to calibrate after port gender adaptation. Purchase a second calibration kit of opposing gender for full calibration of a port adaptor. Alternatively, once a noninsertable calibration has been performed, it is possible to measure the port adaptor(s) and de-embed their error. A third option is to use reference plane shift and/or normalization for a lesser correction of adaptor errors.

Check standards

We offer two economical check standards that can be used to validate the accuracy of a network analysis test setup and its calibration before and during or after measurements are made. Akin to the Beatty line, each check standard is a short length of mismatched line (75 mm of 25 Ω) with a predictable, smooth and stable mismatch and transmission characteristic that spans the frequency range of the PicoVNA 106. These devices validate system measurement accuracy in the presence of high and varying mismatch and thus present a demanding validation on which to base confidence in a setup.

A comparison utility is provided in the PicoVNA 2 software (described on later pages) to evaluate the comparison against a combination of specified measurement uncertainties for the device, test leads and instrument. Each check standard is supplied with Touchstone measurement data on USB memory. The data is traceable via PC3.5 standards to national standards. The supplied Touchstone measurement data is compatible with and can be used to manually validate a measurement of any manufacturer's VNA.

Two check standards are available: insertable SMA(m-f) and noninsertable SMA(f-f).

Order code	Name	Port connectors	Parameter	Minimum	Maximum	Impedance (Ω)	Bandwidth (GHz)	Supports S-parameters and calibration modes
TA430	CHK-INS-MF Insertable with a male and a female port	Port 1: SMA female	Return loss	< -30 dB	> -6 dB	25	6	All S-parameters and insertable 12-term calibration mode
		Port 2: SMA male	Insertion loss	> -0.2 dB	< -1.9 dB			
TA431	CHK-NON-F Noninsertable with female ports	Port 1: SMA female	Return loss	< -30 dB	> -6 dB	25	6	All S-parameters and noninsertable, known and unknown through calibration modes
		Port 2: SMA female	Insertion loss	> -0.2 dB	< -1.9 dB			

Please see Software description and Specifications for further details.

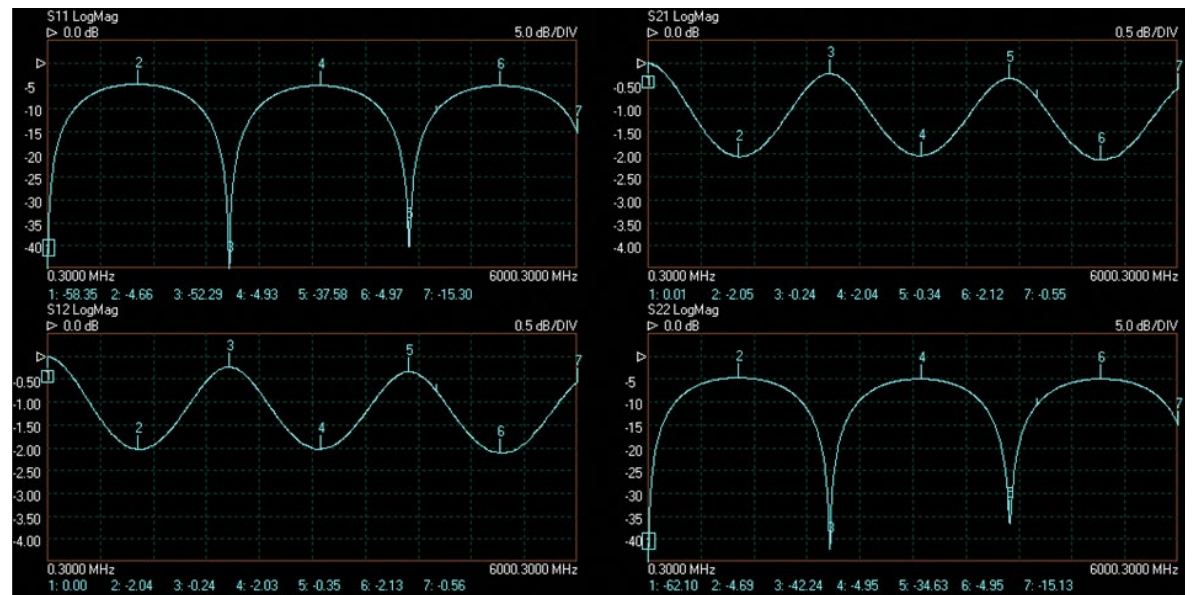

PicoVNA 2 software

PicoVNA 2 presents standard VNA measurement and calibration simply, intuitively and with efficient usage at its heart. The software offers a comprehensive range of measurements and plot formats in its one, two or four user-configurable measurement channels. All the standard vector network analyzer functions and tabulated measurements can be seen at a glance.

Import / export, help and utilities

Save, recall, print, labels, calibration tools
Signal generator, P1dB and AM to PM utilities

Direct access to channel settings

Click or touch and drag values, scales and markers

Display formats
One, two or four channels

1

1

2

1 2

3 4

Plot formats
Log magnitude
Phase
Smith chart
VSWR
Group delay
Linear magnitude
Real
Imaginary
Time domain
Polar linear

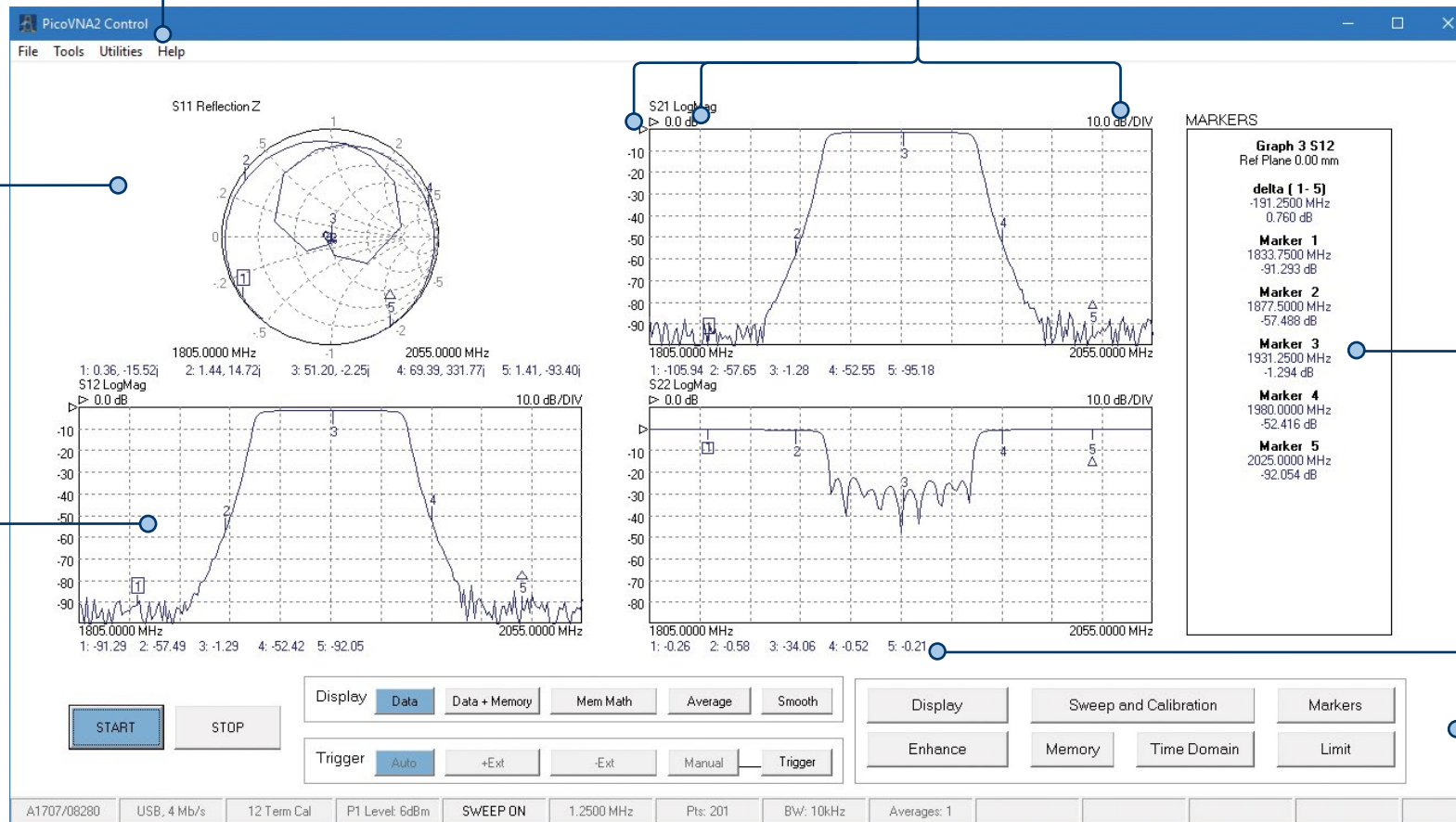

Marker readouts
Table of up to eight markers for the selected channel

Marker summary

User interface
Controls, information and vector trace math functions.

Supported calibrations

The PicoVNA 2 software supports a comprehensive range of calibration modes to address single or dual-port workload with male, female or mixed gender interfaces, all with best achievable accuracy (least uncertainty). In some instances only a single calibration kit may be required, as has been outlined above.

As you would expect, the Pico calibration kits are individually serial-numbered and supplied with S-parameter data. This data is a traceable and accurate record of measured errors for the calibration kit. It can be loaded into the software, which will correct for these errors and those of the instrument during a calibration.

Alternatively, you can use a third-party calibration kit whose 'model', electrical length, parasitic values and polynomial coefficients you can enter into the software. Where a third party has supplied a calibration kit S-parameter data file, please ask us about the possibility of conversion to Pico format.

As for any vector network analyzer, for best accuracy a calibration is performed before a measurement with the same sweep span and frequency steps as the measurement. If, however, a change of sweep settings is necessary for a measurement, the PicoVNA 2 software will for convenience interpolate its corrections to the new sweep settings.

An *enhanced isolation* calibration setting is available for optimum dynamic range when using resolution bandwidths below around 1 kHz.

Reference plane extension

Reference plane extension (offset) allows you to shift the measurement reference plane away from the point established during calibration. This is useful in removing the path length of assumed ideal interconnecting, connectors cables or microstrip lines from measurements. PicoVNA 2 software allows independent reference plane extensions on each of the measurement parameters (S_{11} , S_{22} , S_{12} or S_{21}), either as an automatic re-reference or by manual entry. Independent extensions allow, for example, different extensions on the two ports for S_{11} and S_{22} and then through-line normalization for S_{21} and S_{12} transmission comparison with equivalent length through-line.

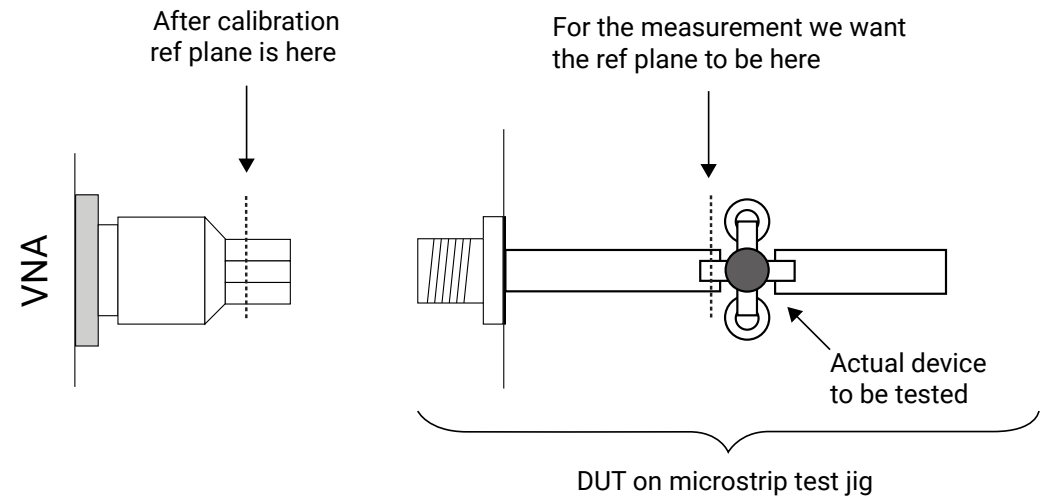

De-embedding embedded port interfaces

When it is unsafe to assume the above ideal interconnecting connectors cables or microstrip lines; for example to achieve greater accuracy or to remove known imperfections in a test setup, we can choose instead to de-embed the interface networks on each measurement port. The PicoVNA 2 software simply requires a full Touchstone .s2p file for the embedded interfacing network on each port. Likewise, defined networks can be embedded into the measurement to achieve a desired simulated measurement. As for a calibration, best accuracy will be achieved when the embedding network is defined at the same frequency points as the intended measurement. Unusually for a vector network analyzer, the PicoVNA 2 software will interpolate where necessary and possible.

Z_0 impedance reference

System measurement impedance (default 50 Ω) can be mathematically converted to any value between 10 Ω and 200 Ω . The PicoVNA 2 software also supports the use of external matching pads and calibration in the new impedance using a calibration kit of that impedance.

Time domain transmission and reflectometry measurements

Time domain reflectometry is useful in the measurement of a transmission line or component; in particular the distance-to-fault location of any discontinuity due to connectors, damage or design error. To achieve this, the PicoVNA 2 software determines from its frequency domain measurements the time domain response to a step input. Using a sweep of harmonically related frequencies, an inverse fast Fourier transform of reflected frequency data (S_{11}) gives the impulse response in the time domain. The impulse response is then integrated to give the step response. Reflected components of the step, occurring at measurable delays after excitation, indicate the type of discontinuity and (assuming a known velocity of propagation) the distance from the calibration plane.

A similar technique is used to derive a TDT (time domain transmission) signal from the transmitted signal data (S_{21}). This can be used to measure the pulse response or transition time of amplifiers, filters and other networks.

The PicoVNA 2 software supports Hanning and Kaiser–Bessel lowpass filtering on its time-domain IFFT conversions, preserving magnitude and phase, and achieving best resolution. Marker readouts include magnitude, time, distance and line impedance in ohms. A DC-coupled DUT is essential to the method.

P1dB utility

The 1 dB gain compression point of amplifiers and other active devices can be measured using a power sweep, either at a test frequency or over a sweep of test frequencies. The VNA determines the small-signal gain of the amplifier at low input power, and then increases the power and notes the point at which the gain has fallen by 1 dB. This utility uses a second-order curve fit to determine interpolated 1 dB compression points.

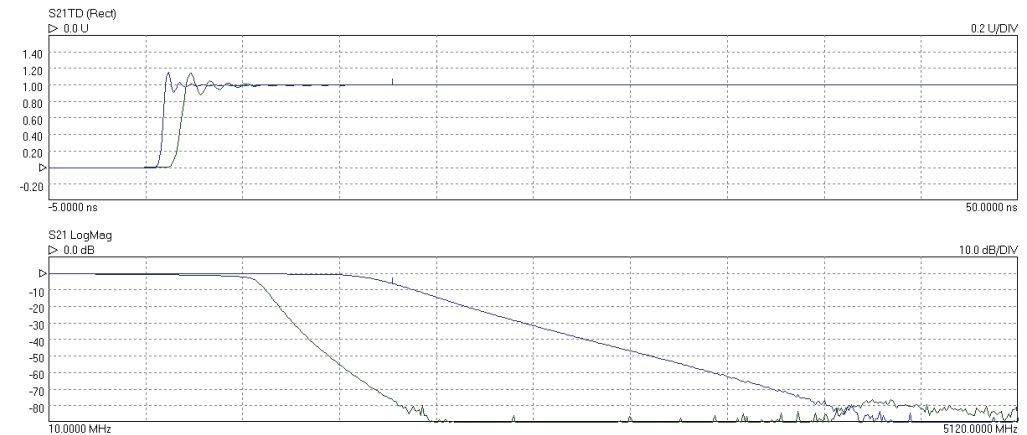

Time domain transmission step responses (top) and frequency responses (bottom) of two lowpass filters

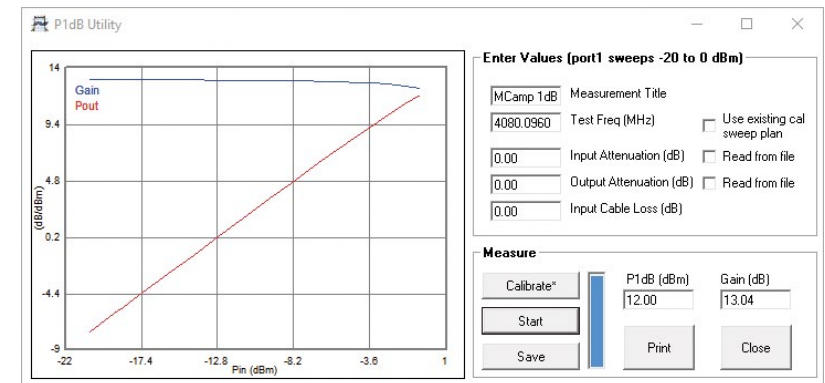

AM to PM conversion utility

AM to PM conversion is a form of signal distortion where changes in the amplitude of a signal produce corresponding changes in the phase of the signal. This type of distortion can have serious impact in digital modulation schemes for which amplitude varies and phase accuracy is important.

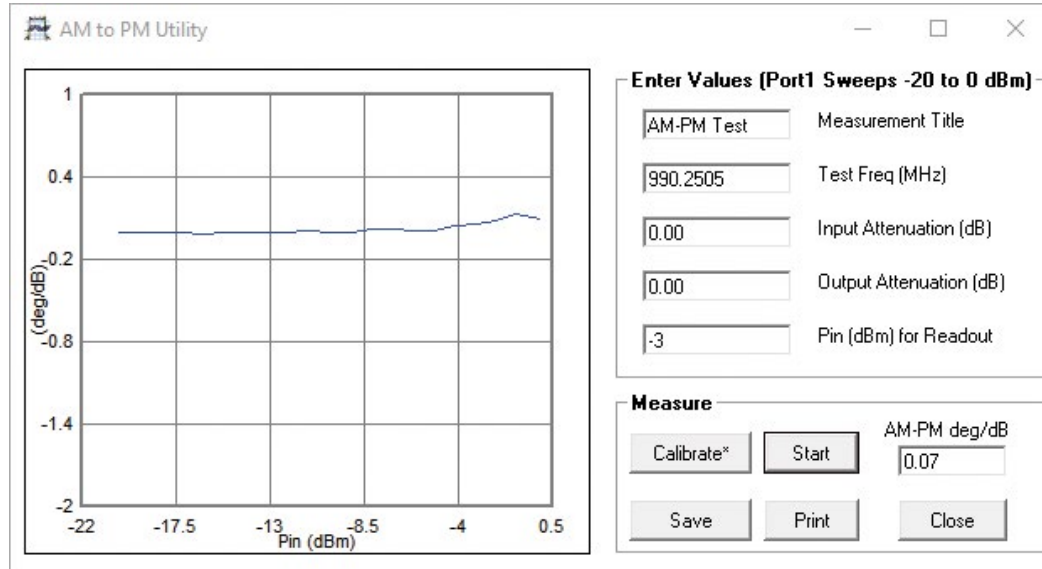

Limit lines testing

The limit lines facility allows six segments to be defined for each displayed plot. These can be extended to 11 segments using an overlapping technique. Visual and audible alarms can be given when a limit line is crossed. All plot formats except Smith chart and polar support limit testing. Peak hold functions are also available.

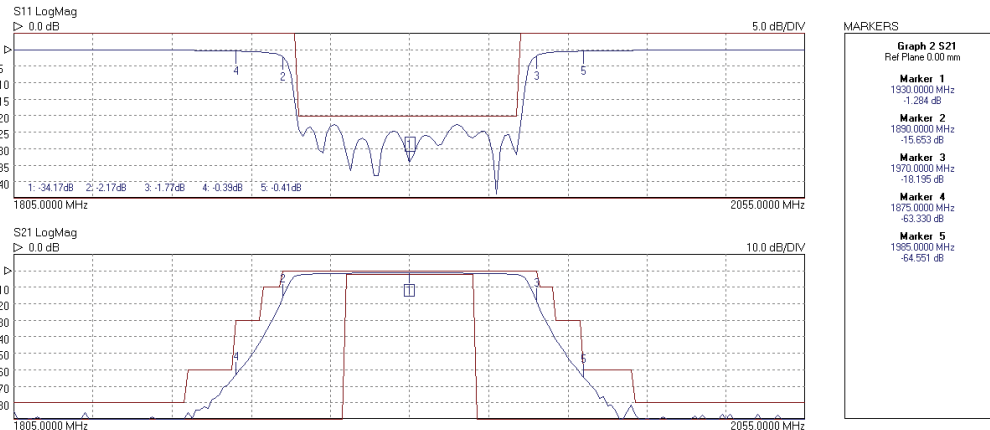

Check standard comparison utility

The supplied Touchstone measurement data for a serial-numbered check standard is loaded into the PicoVNA memory trace as a 'Reference' measurement.

With a valid, full S-parameter, full-span calibration established and the check standard connected between the test ports, the comparison utility performs a measurement. It then compares and tabulates, on each frequency point basis, the measurement with the stored 'Reference' data. Magnitude and phase difference are tabulated.

The utility combines uncertainties for the instrument and test leads (respective specifications) with measurement uncertainty and stability of the check standard (also supplied). The difference between reference and measurement is then compared with total uncertainty, giving a result of 'pass' (within uncertainty) or 'fail' (outside uncertainty).

You can save the comparison dataset for archive or analysis and a Microsoft Excel template (available for download) helps you visualize the comparison and its uncertainties.



This is a very demanding evaluation of an instrument, test leads and the calibration performed, very nearly, to the full specification of the instrument and leads. The test is designed to identify a weak process, or worn, contaminated or damaged system components that might lead to a compromised measurement. To gain a pass, correct calibration procedure must be followed including the use of torque wrenches to make the connections at calibration and comparison measurements. The uncertainty data provided attempts to take into account the expected variability of your measurement setups when mating the check standard with Pico-supplied PC3.5 or SMA port connectors. There is a wide variation in the quality of commercially available test cables and SMA connectors, and contamination, damage or wear can easily occur. We guarantee that the uncertainty data provided will cover your test setups only when you use Pico-supplied calibration standards, port adaptors and test leads in new condition.

Specifications

Standard conditions: 10 Hz resolution bandwidth, at -3 dBm test power, at an ambient temperature of between 20°C and 30°C but within 1°C of the calibration temperature and 60 minutes after power-up.

Receiver characteristics

Parameter	Value	Conditions												
Measurement bandwidth	140 kHz, 70 kHz, 35 kHz, 15 kHz, 10 kHz, 5 kHz, 1 kHz, 500 Hz, 100 Hz, 50 Hz, 10 Hz													
Average displayed noise floor	<table border="1"> <thead> <tr> <th>Band (MHz)</th> <th>Typical (dB)</th> <th>Max. (dB)</th> </tr> </thead> <tbody> <tr> <td>0.3 – 10</td> <td>-110</td> <td>-100</td> </tr> <tr> <td>10 – 4000</td> <td>-118</td> <td>-108</td> </tr> <tr> <td>> 4000</td> <td>-110</td> <td>-100</td> </tr> </tbody> </table>	Band (MHz)	Typical (dB)	Max. (dB)	0.3 – 10	-110	-100	10 – 4000	-118	-108	> 4000	-110	-100	<p>Relative to the test signal level set to maximum power after an S_{21} calibration. Ports terminated as during the isolation calibration step.</p> <p>10 Hz bandwidth Maximum (+6 dBm) test power No averaging</p>
Band (MHz)	Typical (dB)	Max. (dB)												
0.3 – 10	-110	-100												
10 – 4000	-118	-108												
> 4000	-110	-100												
Dynamic range	See graphs (typical, excludes crosstalk)													

Dynamic range 0.3 MHz to 10 MHz

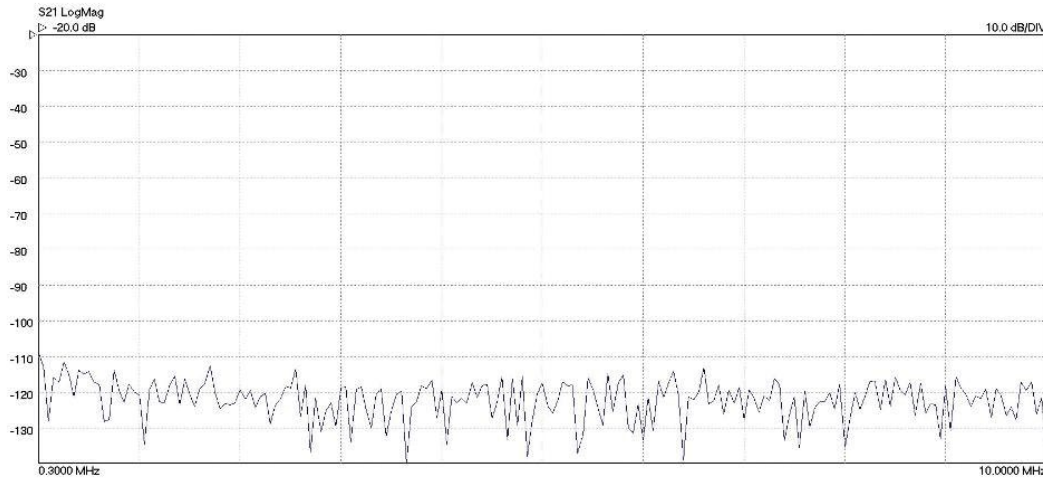

Dynamic range 10 MHz to 6 GHz

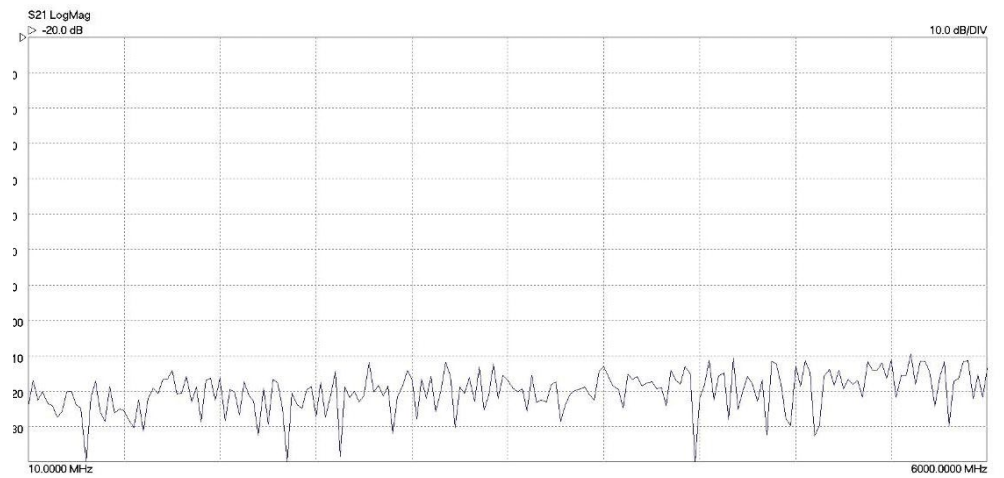

Temperature stability, typical

0.02 dB/°C for $F < 4$ GHz
0.04 dB/°C for $F \geq 4$ GHz

Trace noise (RMS)

Bandwidth (kHz)	Typical (dB)	Max. (dB)
10	0.0008	0.002
70	0.003	0.005
140	0.005	0.01

Measured after an S_{21} calibration

201-point sweep covering 1 MHz to 6 GHz.
Test power set to 0 dBm.

Measurement uncertainty PC3.5 test port interfaces	Level and frequency range		Reflection mag / phase		Transmission mag / phase		Test level of -3 dBm. No averaging. Bandwidth 10 Hz. Ambient temperature equal to the calibration temperature. A 12 error term calibration is assumed carried out with a good quality 3.5 mm calibration kit capable of achieving the performance specified. These values are supplied with our Check Standard on USB memory stick as uncertainty data file UNC_3m5 . dat.
	-15 dB to	< 2 MHz	0.7 dB / 8°	0 dB to	0.4 dB / 6°		
	0 dB	> 2 MHz	0.5 dB / 4°	+6 dB	0.2 dB / 2°		
	-25 dB to	< 2 MHz	0.8 dB / 10°	-40 dB to	0.2 dB / 2°		
	-15 dB	> 2 MHz	1.0 dB / 6°	0 dB	0.1 dB / 1°		
Measurement uncertainty SMA test port interfaces	Level and frequency range		Reflection mag / phase		Transmission mag / phase		Test level of -3 dBm. No averaging. Bandwidth 10 Hz. Ambient temperature equal to the calibration temperature. A 12 error term calibration is assumed carried out with a good-quality SMA or PC3.5 calibration kit capable of achieving the performance specified. These values are supplied with our Check Standard on USB memory stick as uncertainty data file UNC_SMA . dat.
	-15 dB to	< 2 MHz	0.99 dB / 11.3°	0 dB to	0.57 dB / 8.5°		
	0 dB	> 2 MHz	0.71 dB / 5.7°	+6 dB	0.28 dB / 2.8°		
	-25 dB to	< 2 MHz	1.13 dB / 14.1°	-40 dB to	0.42 dB / 2.8°		
	-15 dB	> 2 MHz	1.41 dB / 8.5°	0 dB	0.14 dB / 1.4°		
Spurious responses	Level and frequency range		Reflection mag / phase		Transmission mag / phase		The main spurious response occurs at close to $(2 \times RF + 1.3)$ MHz, where RF is the test frequency in MHz. For example, when testing a bandpass filter with a centre frequency of, say 1900 MHz, an unwanted response will occur around 949.35 MHz. There may also be spurious responses close to $(3 \times RF + 2.6)$ MHz. In all known cases the levels will be as stated.
	-30 dB to	< 2 MHz	4.24 dB / 28.3°	-60 dB to	0.71 dB / 11.3°		
	-25 dB	> 2 MHz	3.54 dB / 21.2°	-40 dB	0.42 dB / 5.7°		
				-80 dB to	2.83 dB / 21.2°		
				-60 dB	2.12 dB / 17.0°		

Test port characteristics			
Load match	40 dB min. corrected, 46 dB, typ. corrected, 16 dB, typ. uncorrected		
Source match	40 dB min. corrected, 46 dB, typ. corrected, 16 dB, typ. uncorrected		
Directivity	40 dB min. corrected, 47 dB, typ. corrected		
Crosstalk	Band (MHz)	Typical (dB)	Max. (dB)
	< 2	-100	-90
	2 to 4000	-110	-90
	4000 to 6000	-100	-90
Maximum input level	+10 dBm, typ		
Maximum input level	+20 dBm		
Impedance	50 Ω		
Connectors	Type N, female		

Calibration kits						
Device	Frequency	PC3.5(f)	PC3.5(m)	SMA(f)*	SMA(m)*	* SMA calibration kits are calibrated in a PC3.5 reference system.
Load uncorrected return loss	≤ 3 GHz	≥ 30 dB	≥ 30 dB	≥ 30 dB	≥ 28 dB	Inferred from directivity after applying correction using measured data provided with the kit
	> 3 GHz	≥ 27 dB	≥ 26 dB	≥ 26 dB	≥ 26 dB	
Load corrected return loss	≤ 3 GHz	≥ 46 dB	≥ 46 dB	≥ 40 dB	≥ 40 dB	
	> 3 GHz	≥ 43 dB	≥ 43 dB	≥ 37 dB	≥ 37 dB	
Open circuit return loss	≤ 3 GHz			≤ 0.15 dB		
	> 3 GHz			≤ 0.2 dB		
Short circuit return loss	≤ 3 GHz			≤ 0.2 dB		
	> 3 GHz			≤ 0.25 dB		
Through adaptor insertion loss	≤ 6 GHz	≤ 0.15 dB	≤ 0.15 dB	≤ 0.15 dB	≤ 0.2 dB	
Transfer calibration method	300 kHz to 1.5 GHz 1.5 GHz to 6 GHz	SOLT comparison TRL comparison		SOLT comparison		SOLT = short, open, load, through TRL = through, reflect, line

Check standards						
Devices	Bandwidth	Return loss	Insertion loss			
TA430 CHK-INS-MF insertable TA431 CHK-NON-F noninsertable	0.3 to 6000 MHz	< -30 dB to > -6 dB	> -0.2 dB to < -1.9 dB	Formed by 75 mm of 25 Ω mismatched line		
Reference uncertainty	Level and frequency range		Reflection mag / phase		Transmission mag / phase	
	-15 dB to 0 dB	< 2 MHz > 2 MHz	0.99 dB / 11.3° 0.71 dB / 5.7°	0 dB to +6 dB	0.57 dB / 8.5° 0.28 dB / 2.8°	
	-25 dB to -15 dB	< 2 MHz > 2 MHz	1.13 dB / 14.1° 1.41 dB / 8.5°	-40 dB to 0 dB	0.42 dB / 2.8° 0.14 dB / 1.4°	
	-30 dB to -25 dB	< 2 MHz > 2 MHz	4.24 dB / 28.3° 3.54 dB / 21.2°	-60 dB to -40 dB	0.71 dB / 11.3° 0.42 dB / 5.7°	
				-80 dB to -60 dB	2.83 dB / 21.2° 2.12 dB / 17.0°	
	Ambient temperature 20 °C to 26 °C					
	These values are supplied with our Check Standard on USB memory stick as uncertainty data file UNC_Meas . dat.					

Bias-T input characteristics	
Maximum current and DC voltage	250 mA, ±15 V
Current protection	Built-in resettable fuse
DC port connectors	SMB(m)

Sweep I/O characteristics	
Sweep trigger output voltage	Low: 0 V to 0.8 V. High: 2.2 V to 3.6 V.
Sweep trigger input voltage	Low: -0.1 V to 1 V. High: 2.0 V to 4 V.
Sweep trigger input voltage	±6 V
Sweep trigger in/out connectors	BNC female on back panel

Measuring functions

Measuring parameters	$S_{11}, S_{21}, S_{22}, S_{12}$ P1dB (1 dB gain compression) AM to PM conversion factor (PM due to AM) 12 error term full S-parameter correction (insertable DUT) 12 error term full S-parameter correction (noninsertable DUT) 8 error term full S-parameter unknown through correction (noninsertable DUT) S_{11} (1-port correction) De-embed (2 embedding networks may be specified) Impedance conversion S_{21} (normalize, normalize + isolation) S_{21} (source match correction + normalize + isolation) Averaging, smoothing Hanning and Kaiser–Bessel filtering on time-domain measurements Electrical length compensation (manual or auto) Effective dielectric constant correction
Error correction	
Display channels	4 channels
Traces	2 traces per display channel
Display formats	Amplitude (logarithmic and linear), phase, group delay, VSWR, real, imaginary, Smith chart, polar, time domain
Memory trace	One per display channel
Limit lines	6 segments per channel (overlap allowed)
Markers	8 markers
Marker functions	Normal, Δ marker, fixed marker, peak / min. hold, 3 dB and 6 dB bandwidth

Sweep functions

Sweep type	Linear frequency sweep and power sweep (P1dB utility)		
Sweep times	Bandwidth	S_{21} cal	12-term cal
	140 kHz	25 ms	37 ms
	10 kHz	52 ms	88 ms
	1 kHz	306 ms	0.6 s
	100 Hz	2.85 s	5.5 s
	10 Hz	28.5 s	57 s
	10 MHz to 6 GHz, 201 point sweep. For other trace lengths and resolution bandwidths the sweep time is approximately: $T_{SWP} = N \times (T_{MIN} + F_{BW} / R_{BW}) + T_{ARM}$ where: N = number of frequency points T_{MIN} = minimum time / point (s2p: 169 μ s; s1p: 115 μ s) F_{BW} = bandwidth settle factor (s2p: 2.81; s1p: 1.425) R_{BW} = resolution bandwidth (Hz) For sweep repetition period add rearm time (average 9.5 ms or maximum 17.5 ms)		
Number of sweep points, VNA mode	51, 101, 201, 401, 801, 1001, 2001, 4001, 5001, 6001, 7001, 8001, 9001, 10001		
Number of sweep points, TD mode	512, 1024, 2048, 4096		

Signal source characteristics

Frequency range	300 kHz to 6.0 GHz	
Frequency setting resolution	10 Hz	
Frequency accuracy	10 ppm max	With ambient of 23 ±3 °C
Frequency temperature stability	±0.5 ppm/°C max	Over the range +15 °C to +35 °C
Harmonics	-20 dBc max	With test power set to < -3 dBm
Non-harmonic spurious	-40 dBc typical	
Phase noise (10 kHz offset)	0.3 MHz to 1 GHz: -90 dBc/Hz 1 GHz to 4 GHz: -80 dBc/Hz > 4 GHz: -76 dBc/Hz	
Test signal power	< 10 MHz: -3 to -20 dBm 10 MHz to 4 GHz: +6 to -20 dBm > 4 GHz: +3 to -20 dBm	
Power setting resolution	0.1 dB	
Power setting accuracy	±1.5 dB	
Reference input frequency	10 MHz ±6 ppm	
Reference input level	0 ±3 dBm	
Reference output level	0 ±3 dBm	

Miscellaneous

Controlling PC data interface	USB 2.0
Support for third party test software	Dynamic Link Library (DLL) as part of user interface software
External dimensions (mm)	286 x 174 x 61 (L x W x H) excluding connectors
Weight	1.85 kg
Temperature range (operating)	5 °C to 40 °C
Temperature range (storage)	-20 °C to +50 °C
Humidity	80% max, non-condensing
Vibration (storage)	0.5 g, 5 Hz to 300 Hz
Power source and current	+12 to +15 V DC, 22 W
Power source connector	5.5 mm diameter hole, 2.1 mm diameter centre contact pin. Centre pin is positive.
Host PC requirements	Microsoft Windows 7, 8 or 10 2 GB RAM or more
Safety	Conforms to EN61010-1:2010 and EN61010-2-030:2010
Warranty	3 years

PicoVNA 106 kit (PQ111) contents

PicoVNA 106 6 GHz vector network analyzer
(Calibrated. Certificate with data available separately.)



PS010 Universal input 12 V 4.5 A output power supply



PA153 PicoVNA 106 carry case



DI111 PicoVNA 2 software and documents on USB flash drive



TA359 Adjustable connector wrench



TA177 SMA M8 combination wrench



MI106 Pico blue USB 2.0 cable 1.8 m



Available separately

TA356 Dual-break torque wrench SMA / PC3.5 / K-type,
1 N·m / 8.85 in·lb



TA358 Dual-break torque wrench N-type 1 N·m / 8.85 in·lb



TA336 Standard test lead with SMA(m) port
TA337 Standard test lead with SMA(f) port
TA338 Premium test lead with PC3.5(m) port
TA339 Premium test lead with PC3.5(f) port



TA340 Standard PC3.5 port adaptor (m-m)
TA341 Standard PC3.5 port adaptor (f-f)
TA354 Standard PC3.5 port saver (m-f)
TA342 Premium SMA port adaptor (m-m)
TA343 Premium SMA port adaptor (f-f)
TA357 Premium SMA port saver (m-f)



TA344 Standard SOLT calibration kit SMA(m) with data
TA345 Standard SOLT calibration kit SMA(f) with data
TA346 Premium SOLT calibration kit PC3.5(m) with data
TA347 Premium SOLT calibration kit PC3.5(f) with data



TA430 Insertable check standard SMA(m-f) with data
TA431 Noninsertable check standard SMA(f-f) with data



CO046 PicoVNA 106 calibration and certificate with data
CO047 Recalibration of standard calibration kit
CO048 Recalibration of premium calibration kit
CO050 Remeasurement of check standard



See overleaf for further optional RF and Microwave accessories including attenuators, cables and adaptors.

Ordering information

Order code	Description
PQ111	PicoVNA 106 6 GHz vector network analyzer
TA336	Standard 6 GHz flexible test lead, male port, N(m)-SMA(m)
TA337	Standard 6 GHz flexible test lead, female port, N(m)-SMA(f)
TA338	Premium 6 GHz flexible test lead, male port, N(m)-PC3.5(m)
TA339	Premium 6 GHz flexible test lead, female port, N(m)-PC3.5(f)
TA342	ADA-STD-MM Standard test port adaptor, SMA(m-m)
TA343	ADA-STD-FF Standard test port adaptor, SMA(f-f)
TA357	ADA-STD-FM Standard within series adaptor, SMA(f-m)
TA340	ADA-PREM-MM Premium test port adaptor, PC3.5(m-m)
TA341	ADA-PREM-FF Premium test port adaptor, PC3.5(f-f)
TA354	ADA-PREM-FM Premium within series adaptor, PC3.5(f-m)
TA344	SOLT-STD-M Standard 6 GHz SOLT calibration kit, SMA(m)
TA345	SOLT-STD-F Standard 6 GHz SOLT calibration kit, SMA(f)
TA346	SOLT-PREM-M Premium 6 GHz SOLT calibration kit, PC3.5(m)

Order code	Description
TA347	SOLT-PREM-F Premium 6 GHz SOLT calibration kit, PC3.5(f)
TA430	CHK-INS-MF Insertable check standard, SMA(m-f)
TA431	CHK-NON-F Noninsertable check standard, SMA(f-f)
MI030	BNC-BNC cable 1 m
TA170	Adaptor 18 GHz 50 Ω, SMA(m-f)
TA314	Adaptor 18 GHz 50 Ω, SMA(f)-N(m)
TA262	Attenuator 10 dB 10 GHz 50 Ω, SMA(m-f)
TA173	Attenuator 20 dB 10 GHz 50 Ω, SMA(m-f)
TA181	Attenuator 3 dB 10 GHz 50 Ω, SMA(m-f)
TA261	Attenuator 6 dB 10 GHz 50 Ω, SMA(m-f)
TA265	Precision sleeved coaxial cable 30 cm 1.3 dB @ 13 GHz
TA312	Precision sleeved coaxial cable 60 cm 2.2 dB @ 13 GHz
TA358	Dual-break torque wrench N-type 1 N·m (8.85 in·lb)
TA356	Dual-break torque wrench SMA/PC3.5/K, 1 N·m (8.85 in·lb)
CC046	Calibration certificate and data for PicoVNA 106
CC047	Calibration for SOLT-STD-M or SOLT-STD-F
CC048	Calibration for SOLT-PREM-M or SOLT-PREM-F
CC050	Calibration for CHK-INS-MF or CHK-NON-F

UK headquarters:

Pico Technology
James House
Colmworth Business Park
St. Neots
Cambridgeshire
PE19 8YP
United Kingdom

☎ +44 (0) 1480 396 395
☎ +44 (0) 1480 396 296
✉ sales@picotech.com

North America regional office:

Pico Technology
320 N Glenwood Blvd
Tyler
Texas 75702
United States

☎ +1 800 591 2796
☎ +1 620 272 0981
✉ sales@picotech.com

Asia-Pacific regional office:

Pico Technology
Room 2252, 22/F, Centro
568 Hengfeng Road
Zhabei District
Shanghai 200070
PR China

☎ +86 21 2226-5152
✉ pico.china@picotech.com

testoon.COM
The measurement website

99 rue Beranger - 92320 Chatillon - France
Tel. : +33 (0) 1 71 16 17 00 - Fax : +33 (0) 1 71 16 17 03
www.testoon.com

* Prices correct at the time of publication. Sales taxes not included. Please check www.picotech.com for the latest prices before ordering. Errors and omissions excepted. *Pico Technology* is an internationally registered trade mark of Pico Technology Ltd. *PicoVNA* is a registered trade mark of Pico Technology Ltd.

MM084.en-5. Copyright © 2017–2018 Pico Technology Ltd. All rights reserved.



www.picotech.com