

R&S® NGA100

Power Supply

User Manual



5601891902
Version 02

ROHDE & SCHWARZ
Make ideas real



This manual describes the following R&S®NGA100 models with firmware version 1.00 and higher:

- R&S®NGA101 One-Channel 35V/6A Power Supply 40 W (5601.8002.02)
- R&S®NGA102 Two-Channel 35V/6A Power Supply 80 W (5601.8002.04)
- R&S®NGA141 One-Channel 100V/2A Power Supply 40 W (5601.8002.03)
- R&S®NGA142 Two-Channel 100V/2A Power Supply 80 W (5601.8002.05)

In addition to the base unit, the following options are described:

- R&S®NGA-K102 Option Wireless LAN (5601.8419.03)
- R&S®NGA-K103 Option Digital I/O (5601.8425.03)

© 2021 Rohde & Schwarz GmbH & Co. KG

Mühlhofstr. 15, 81671 München, Germany

Phone: +49 89 41 29 - 0

Email: info@rohde-schwarz.com

Internet: www.rohde-schwarz.com

Subject to change – data without tolerance limits is not binding.

R&S® is a registered trademark of Rohde & Schwarz GmbH & Co. KG.

Trade names are trademarks of the owners.

5601.8919.02 | Version 02 | R&S®NGA100

Throughout this manual, products from Rohde & Schwarz are indicated without the ® symbol, e.g. R&S®NGA is indicated as R&S NGA100.

Safety Instructions

Instrucciones de seguridad

Sicherheitshinweise

Consignes de sécurité

WARNING

Risk of injury and instrument damage

The instrument must be used in an appropriate manner to prevent electric shock, fire, personal injury or instrument damage.

- Do not open the instrument casing.
 - Read and observe the "Basic Safety Instructions" delivered as printed brochure with the instrument.
 - Read and observe the safety instructions in the following sections. Note that the data sheet may specify additional operating conditions.
 - Keep the "Basic Safety Instructions" and the product documentation in a safe place and pass them on to the subsequent users.
-

ADVERTENCIA

Riesgo de lesiones y daños en el instrumento

El instrumento se debe usar de manera adecuada para prevenir descargas eléctricas, incendios, lesiones o daños materiales.

- No abrir la carcasa del instrumento.
 - Lea y cumpla las "Instrucciones de seguridad elementales" suministradas con el instrumento como folleto impreso.
 - Lea y cumpla las instrucciones de seguridad incluidas en las siguientes secciones. Se debe tener en cuenta que las especificaciones técnicas pueden contener condiciones adicionales para su uso.
 - Guarde bien las instrucciones de seguridad elementales, así como la documentación del producto, y entréguelas a usuarios posteriores.
-

⚠️ WARNUNG**Gefahr von Verletzungen und Schäden am Gerät**

Betreiben Sie das Gerät immer ordnungsgemäß, um elektrischen Schlag, Brand, Verletzungen von Personen oder Geräteschäden zu verhindern.

- Öffnen Sie das Gerätegehäuse nicht.
 - Lesen und beachten Sie die "Grundlegenden Sicherheitshinweise", die als gedruckte Broschüre dem Gerät beiliegen.
 - Lesen und beachten Sie die Sicherheitshinweise in den folgenden Abschnitten; möglicherweise enthält das Datenblatt weitere Hinweise zu speziellen Betriebsbedingungen.
 - Bewahren Sie die "Grundlegenden Sicherheitshinweise" und die Produktdokumentation gut auf und geben Sie diese an weitere Benutzer des Produkts weiter.
-

⚠️ AVERTISSEMENT**Risque de blessures et d'endommagement de l'appareil**

L'appareil doit être utilisé conformément aux prescriptions afin d'éviter les électrocutions, incendies, dommages corporels et matériels.

- N'ouvrez pas le boîtier de l'appareil.
 - Lisez et respectez les "consignes de sécurité fondamentales" fournies avec l'appareil sous forme de brochure imprimée.
 - Lisez et respectez les instructions de sécurité dans les sections suivantes. Il ne faut pas oublier que la fiche technique peut indiquer des conditions d'exploitation supplémentaires.
 - Gardez les consignes de sécurité fondamentales et la documentation produit dans un lieu sûr et transmettez ces documents aux autres utilisateurs.
-



이 기기는 업무용(A급) 전자파
적합기기로서 판매자 또는
사용자는 이 점을 주의하시기
바라며, 가정외의 지역에서
사용하는 것을 목적으로 합니다.

Contents

1	Documentation Overview.....	7
1.1	Manuals.....	7
1.2	Data Sheet.....	7
1.3	Calibration Certificate.....	7
1.4	Release Notes, Open Source Acknowledgment.....	8
2	Welcome to R&S NGA100.....	9
3	Important Notes.....	10
3.1	Symbols.....	10
3.2	Ambient Conditions.....	10
3.3	Measurement Categories.....	11
3.4	Mains Voltage.....	11
3.5	Limits.....	12
4	Getting Started.....	13
4.1	Putting into Operation.....	13
4.1.1	Safety.....	14
4.1.2	Intended Operation.....	15
4.1.3	Unpacking and Checking the Instrument.....	16
4.1.4	Setting Up the Instrument.....	17
4.1.4.1	Bench Operation.....	17
4.1.4.2	Rack Mounting.....	18
4.2	Instrument Tour.....	18
4.2.1	Overview of Controls.....	18
4.2.1.1	Front Panel.....	18
4.2.1.2	Rear Panel.....	20
4.2.1.3	Bottom Panel.....	21
4.2.2	Switching On the Instrument.....	22
4.3	Trying Out the Instrument.....	23
4.3.1	Selecting the Channels.....	23
4.3.2	Setting the Output Voltage and Current Limit.....	23
4.3.3	Activating the Channels Output.....	24

4.3.4	Storing/Recalling of Instrument Settings.....	24
4.4	Maintenance and Support.....	24
4.4.1	Maintenance.....	24
4.4.2	Contacting Customer Support.....	25
5	Operating Basics.....	26
5.1	Display Overview.....	26
5.1.1	Status Bar Information.....	26
5.1.2	Channel Display Area.....	27
5.2	Front Panel Keys.....	28
5.2.1	Function Keys.....	29
5.2.1.1	Output and Channel Controls.....	29
5.2.1.2	Navigation Keys.....	30
5.2.1.3	Instrument Functions.....	30
5.2.1.4	Memory Functions.....	30
5.2.2	Navigation Controls.....	31
5.2.2.1	Rotary Knob.....	31
5.2.2.2	Arrow Keys.....	31
5.2.2.3	Live-Mode.....	32
5.2.3	Menu Key.....	32
5.3	On-screen Keyboard.....	34
5.4	Power Derating.....	35
5.5	Operation Modes.....	36
6	Instrument Functions.....	38
6.1	Setting the Channels Voltage and Current.....	38
6.2	Activating the Channel Output.....	39
6.3	Current Range.....	40
6.4	Remote Sense Function.....	41
6.5	Channel Fusion.....	42
6.6	Activating Fuse.....	44
6.6.1	Fuse Delay, Fuse Linking.....	45
6.7	Tracking Function.....	46
6.8	Protection.....	46
6.9	Digital Trigger I/O.....	48

6.10	Data Logging	51
6.11	Advanced Functions	52
6.11.1	EasyArb.....	52
6.11.2	EasyRamp.....	54
6.12	Store and Recall	55
6.13	Interfaces and Protocols	57
6.13.1	Network Connection.....	57
6.13.1.1	LAN Connection.....	58
6.13.1.2	Wireless LAN Connection.....	60
6.13.2	USB Connection.....	61
6.13.2.1	USB VCP.....	62
6.13.2.2	USB TMC.....	63
6.13.3	SCPI.....	64
6.13.4	VISA.....	64
6.13.5	Setting Up Remote Control Connection.....	65
6.14	General Instrument Settings	66
6.14.1	Instrument Information.....	66
6.14.2	General Instrument Settings.....	67
6.14.3	Managing Options.....	67
6.14.4	Reset Instrument.....	68
6.14.5	System Test.....	70
6.14.6	Updating the Firmware.....	70
6.14.7	Help.....	72
6.14.8	Date Time.....	72
7	Remote Control Commands	74
7.1	Common Commands	74
7.2	System Commands	76
7.3	Configuration Commands	79
7.3.1	Channel Selecting.....	79
7.3.2	Remote Sense Setting.....	80
7.3.3	Voltage Setting.....	81
7.3.4	Current Setting.....	82
7.3.5	Combined Setting of Voltage and Current Setting.....	83

7.3.6	Output Setting.....	84
7.3.7	Fuse Setting.....	87
7.3.8	OVP Setting.....	91
7.3.9	OPP Setting.....	94
7.4	Measurement Commands.....	97
7.5	Advanced Operating Commands.....	97
7.5.1	Arbitrary Commands.....	98
7.5.2	EasyRamp Commands.....	100
7.5.3	DIO Commands.....	100
7.6	Data and File Management Commands.....	105
7.7	Firmware Update.....	106
8	Applications.....	108
8.1	Parallel and Series Mode.....	108
8.1.1	Series Mode.....	108
8.1.2	Parallel Mode.....	109
	Annex.....	111
A	Additional Basics on Remote Control.....	111
A.1	Messages and Command Structure.....	111
A.1.1	Messages.....	111
A.1.2	SCPI Command Structure.....	112
A.2	Command Sequence and Synchronization.....	115
A.2.1	Preventing Overlapping Execution.....	116
	List of commands.....	117
	Index.....	119

1 Documentation Overview

This section provides an overview of the R&S NGA100 user documentation.

1.1 Manuals

You find the documents on the R&S NGA100 product page at:

www.rohde-schwarz.com/manual/nga100

Getting Started

Introduces the R&S NGA100 power supply series and describes how to set up and start working with the instrument. The printed document is delivered with the instrument.

User manual

Contains the description of all instrument modes and functions. It also provides an introduction to remote control, a complete description of the remote control commands with programming examples, and information on maintenance and instrument interfaces. Includes the contents of the getting started manual.

The *online version* of the user manual provides the complete contents for immediate display on the internet.

Basic safety instructions

Contains safety instructions, operating conditions and further important information. The printed document is delivered with the instrument.

Instrument security procedures manual

Deals with security issues when working with the R&S NGA100 in secure areas.

1.2 Data Sheet

The datasheet contains the technical specifications of the R&S NGA100 power supply series. It also lists all options with their order numbers and accessories.

See www.rohde-schwarz.com/brochure-datasheet/nga100

1.3 Calibration Certificate

The document is available on <https://gloris.rohde-schwarz.com/calcert>. You need the device ID of your instrument, which you can find on a label on the rear panel.

1.4 Release Notes, Open Source Acknowledgment

The release notes list new features, improvements and known issues of the current firmware version, and describe the firmware installation. The open source acknowledgment document provides verbatim license texts of the used open source software. It can also be downloaded from the instrument.

See www.rohde-schwarz.com/firmware/nga100.

2 Welcome to R&S NGA100

The one-channel or two-channel power supply series are based on a classical transformer concept with high efficiency electronic pre-regulators and secondary linear regulators. This concept allows the instrument to achieve the high output power within a minimum space, high efficiency and lowest residual ripple.

The R&S NGA100 power supply series feature galvanically isolated, floating overload and short-circuit proof outputs with adjustable power ratings. The outputs can be connected in series or in parallel, thus making high currents and voltages available.

Multi-purpose protection functions are available for each channel which you can set separately, such as overcurrent protection (FUSE), overvoltage protection (OVP), over-power protection (OPP) and overtemperature protection (OTP). If such a limit is reached, the affected output channel is automatically turned off and an indicator message (FUSE, OVP, OPP or OTP) is displayed. The overcurrent protection can be linked to other channel (FuseLink function). In this case, all linked channels are turned off when the set channel reaches its limit.

The EasyArb function allows channel 1 (Ch 1) to have freely definable voltage and current sequences with a timeframe as short as 10 ms. It allows you to vary the voltage or current limit during a test sequence, for example to simulate different charging conditions of a battery. With EasyRamp function, the R&S NGA100 provides the operating condition to simulate the continuous rise of the supply voltage within a defined timeframe of 10 ms to 10 s.

Four data lines of the digital I/O interface are mutually independent and can be used as trigger input or trigger output separately. Various trigger conditions (e.g. fuse tripped, voltage, current, indicator messages) can be used to turn off, on or invert the output state when the trigger condition is met.







All R&S NGA100 power supply series are equipped with a color LCD display (320 x 240 pixels resolution). The R&S NGA100 comes with a USB interface, LAN and optional wireless LAN (WLAN) interface.

For models with WLAN, network connection can also be established wirelessly.

This user manual contains a description of the functionalities that the instrument provides. The latest version is available for download at the product homepage (<http://www.rohde-schwarz.com/product/nga100>).

3 Important Notes

3.1 Symbols

	Caution, general danger zone
	Ground
	PE terminal
	ON (supply voltage)
	OFF (supply voltage)
	Ground terminal

3.2 Ambient Conditions

The allowed operating temperature ranges from +5 °C to +40 °C (pollution category 2). The maximum relative humidity (without condensation) is at 80 %.

During storage and transport, the temperature must be between -20 °C and +70 °C. In case of condensation during transportation or storage, the instrument requires approximately two hours to dry and reach the appropriate temperature prior to operation. The instrument is designed for use in a clean and dry indoor environment. Do not operate with high dust and humidity levels, if danger of explosion exists or with aggressive chemical agents.

Any operating position may be used; however adequate air circulation must be maintained. For continuous operation, a horizontal or inclined position (integrated stand) is preferable.

Specifications with tolerance data apply after a warm-up period of at least 30 minutes at a temperature of 23 °C (tolerance -3 °C / + 7 °C).

The heat produced inside the instrument is guided to the exterior via temperature-controlled fan. Each channel has multiple temperature sensors which check the heat generation in the instrument and control the fan speed.

It is necessary to ensure that there is sufficient space around the instrument sides for heat exchange. If the temperature inside the instrument increases more than the

allowed limit, overtemperature protection is triggered and the affected outputs are switched off automatically.

CAUTION

Air circulation

Do not obstruct the ventilation holes!

3.3 Measurement Categories

This instrument is designed for supplying power-on circuits that are only indirectly connected to the low voltage mains or not connected at all. The instrument is not intended for measurements within the measurement categories II, III or IV; the maximum potential against earth generated by the user must not exceed 250 V peak in this application.

The following information refers solely to user safety. Other aspects, such as the maximum voltage, are described in the technical data and must also be observed.

The measurement categories refer to transients that are superimposed on the mains voltage. Transients are short, very fast (steep) current and voltage variations which may occur periodically and non-periodically. The level of potential transients increases as the distance to the source of the low voltage installation decreases.

- Measurement CAT IV: Measurements at the source of the low voltage installations (e.g. meters)
- Measurement CAT III: Measurements in building installations (e.g. power distribution installations, power switches, firmly installed sockets, firmly installed engines etc.)
- Measurement CAT II: Measurements on circuits electronically directly connected to the mains (e.g. household appliances, power tools, etc.)
- 0 (instruments without measured measurement category): Other circuits that are not connected directly to the mains

3.4 Mains Voltage

The instrument uses 50 Hz / 60 Hz mains voltages ranging from 100 VAC, 115 VAC or 230 VAC (tolerance $\pm 10\%$). Mains voltage must be set correctly by moving the selector according to the voltage selector located at the [bottom panel](#). The input line fuse is accessible externally. Power socket and fuse holder form a single unit.

You need to first disconnect the power cord from the connector before you can safely replace the fuse (as long as the fuse holder is undamaged). Next, the fuse holder must be pried out using a screwdriver. The starting point is a slot next to the contacts. The fuse can then be forced out of its mounting and must be replaced with an identical fuse (see information about the fuse type on the rear panel). The fuse holder is inserted against the spring pressure until it locks into place. The use of mended fuses or short

circuiting the fuse holder is prohibited. Resulting damages are not covered by the warranty.

NOTICE

Safe operation

If the instrument is not in use, it must be switched off at the mains switch for safety reasons.

3.5 Limits

The R&S NGA100 is equipped with a protective overload feature. The protective overload feature prevents damage to the instrument and is intended to protect against a possible electrical shock. The maximum values for the instrument must not be exceeded. The protection limits are listed on the front panel of the R&S NGA100 to ensure the safe operation of the instrument.

These protection limits must be adhered to:

Specification	Limits
Maximum output voltage	35 V module: 35.00 VDC 100 V module: 100.00 VDC
Maximum output current	35 V module: 6.0 100 V module: 2.0
Maximum voltage against earth	250 VDC
Maximum reverse voltage	35 V module: 36.00 VDC 100 V module: 102.00 VDC
Maximum inverse voltage	0.4 VDC
Maximum permitted current in case of inverse voltage	35 V module: 6.00 A 100 V module: 2.00 A
Power supply	100 VAC, 115 VAC or 230 VAC (tolerance $\pm 10\%$)
Frequency	50 Hz / 60 Hz
Maximum power output	40 W (R&S NGA101, R&S NGA141) 80 W (R&S NGA102, R&S NGA142)

4 Getting Started

4.1 Putting into Operation

This chapter describes the steps to set up the R&S NGA100 for the first time.

⚠ WARNING**Risk of injury and instrument damage**

The instrument must be used in an appropriate manner to prevent electric shock, fire, personal injury, or damage.

- Do not open the instrument casing
- Read and observe the "Basic Safety Instructions" delivered as a printed brochure with the instrument. Note that the basic safety instructions also contain information on operating conditions that prevent damage to the instrument

In addition, read and observe the safety instructions in the following sections. Notice that the data sheet may specify additional operating conditions.

NOTICE**Risk of instrument damage during operation**

An unsuitable operating site or test setup can cause damage to the instrument and the connected devices. Ensure the following operating conditions before you switch on the instrument:

- The instrument is dry and shows no sign of condensation
 - The instrument is positioned as described in [Chapter 4.1.4.1, "Bench Operation"](#), on page 17
 - The ambient temperature does not exceed the range specified in the data sheet
 - Voltage levels at the input connectors are all within the specified ranges
 - Voltage outputs are correctly connected and not overloaded
-

⚠ WARNING**Risk of radio interference**

This is a class A product. In a domestic environment, this product may cause radio interference in which case the user may be required to take adequate measures.



EMI impact on measurement results

Electromagnetic interference (EMI) may affect the measurement results.

To suppress the generated EMI:

- Use suitable shielded cables of high quality, for example, LAN cables
- Note the EMC classification in the data sheet

• Safety	14
• Intended Operation	15
• Unpacking and Checking the Instrument	16
• Setting Up the Instrument	17

4.1.1 Safety

NOTICE

Recommendations on secure operation

The R&S NGA100 is designed to operate at local workplaces or in secured networks (LAN). It should not be accessible from the internet, because of a potential security risk, e.g. attackers could misuse or damage your device.

Please always install the latest firmware.

It is highly recommended that you work closely with your IT department or system administrator to ensure compliance with your company policies when connecting devices to your company's network.

This instrument was built in compliance with DIN EN 61010-1 (VDE 0411 part 1), safety regulations for electrical instruments, control units and laboratory equipment. It has been tested and shipped from the plant in safe condition. It is also in compliance with the regulations of the European standard EN 61010-1 and the international standard IEC 61010-1.

To maintain this condition and ensure safe operation, you must observe all instructions and warnings given in this user manual. Casing, chassis and all measuring ports are connected to a protective earth conductor. The instrument is designed in compliance with the regulations of protection class I.

For safety reasons, the instrument may only be operated with authorized safety sockets. The power cord must be plugged in before signal circuits may be connected.

Never use the product if the power cable is damaged. Check regularly that the power cables are in perfect condition. Choose suitable protective measures and installation types to ensure that the power cord cannot be damaged and that no harm is caused by tripping hazards or from electric shock, for instance.

⚠ DANGER**Risk of electric shock**

It is prohibited to disconnect the earthed protective connection inside or outside of the instrument!

If it is assumed that a safe operation is no longer possible, the instrument must be shut down and secured against any unintended operation.

Safe operation can no longer be assumed as follows:

- Instrument shows visible damage
- Instrument includes loose parts
- Instrument no longer functions properly
 - After an extended period of storage under unfavorable conditions (e.g. outdoors or in damp rooms)
 - After rough handling during transport (e.g. packaging that does not meet the minimum requirements by post office, railway or forwarding agency)

⚠ DANGER**Exceeding the low voltage protection**

Use insulated wires and not bare wires for the terminal connection.

For the series connection of all output voltages of the 35 V variant, it is possible to exceed the low voltage protection of 42 V. Please note that in this case any contact with live components is life-threatening. It is assumed that only qualified and trained personnel service the power supplies and the connected loads.

Before switching on the product, it must be ensured that the nominal voltage setting on the product matches the nominal voltage of the AC supply network. If it is necessary to set a different voltage, the power fuse of the product must be changed accordingly.

4.1.2 Intended Operation

The instrument is intended only for use by personnel familiar with the potential risks of measuring electrical quantities.

For safety reasons, the instrument may only be connected to properly installed safety socket outlets. Separating the ground is prohibited.

The power plug must be inserted before signal circuits may be connected.



Use only the power cord included in the delivery package. See "[Delivery package](#)" on page 17.

Before each measurement, measuring cables must be inspected for damage and replaced if necessary. Damaged or worn components can damage the instrument or cause injury.

The product may be operated only under the operating conditions and in the positions specified by the manufacturer, without the product's ventilation being obstructed. If the manufacturer's specifications are not observed, this can result in electric shock, fire and/or serious personal injury, and in some cases, death.

Applicable local or national safety regulations and rules for the prevention of accidents must be observed in all work performed.

The instrument is designed for use in the following sectors: Industrial, residential, business and commercial areas and small businesses.

The instrument is designed for indoor use only. Before each measurement, you need to verify at a known source if the instrument functions properly.



To disconnect from the mains, the low-heat device socket on the back panel has to be unplugged.

See [Table 4-1](#) for the general data on the instrument specification. For more information, see the instrument product brochure.

Table 4-1: General data on instrument specification

Mains nominal voltage	AC	100 / 115 / 230 V ($\pm 10\%$) 50 / 60 Hz
Power consumption	Maximum input power	230 W
Mains fuses (fuse size: 5 mm x 20 mm)	110/115 V AC	IEC 60127 T2.5H250V
	230 V AC	IEC 60127 T5.0H250V
Temperature	Operating temperature range	5 °C to + 40 °C
	Storage temperature range	- 20 °C to + 70 °C
Humidity	Non-condensing	5 % to 80 %
Display		3.5 " (QVGA)
Rack mount capability		R&S HZN96 rack adapter 2U (P/N: 3638.7813.02)
Dimensions	W x H x D	222 mm x 96 mm x 446 mm (8.74 in x 3.78 in x 17.56 in)
Weight	R&S NGA101, R&S NGA141	6.6 kg (14.55 lb), 6.9 kg (15.21 lb)
	R&S NGA102, R&S NGA142	7.0 kg (15.43 lb), 7.3 kg (16.09 lb)

4.1.3 Unpacking and Checking the Instrument

Check the equipment for completeness using the delivery note and package contents list for the various items. Check the instrument for any damage and loose parts. If there is any damage, immediately contact the carrier who delivered the instrument.

**Packing material**

Retain the original packing material. If the instrument needs to be transported or shipped at a later date, you can use the material to protect the control elements and connectors.

NOTICE**Risk of damage during transportation and shipment**

Insufficient protection against mechanical and electrostatic effects during transportation and shipment can damage the instrument.

- Always ensure that sufficient mechanical and electrostatic protections are provided
- When shipping an instrument, the original packaging should be used. If you do not have the original packaging, use sufficient padding to prevent the instrument from moving around inside the box. Pack the instrument in antistatic wrap to protect it from electrostatic charging
- Secure the instrument to prevent any movement and other mechanical effects during transportation

Delivery package

The package contents contain the following items:

- R&S NGA100 power supply preloaded with two 230 V fuses
- Four power cables
- Two 115 V fuses (replace the preloaded fuses with these fuses depending on the mains voltage, see [Chapter 4.2.2, "Switching On the Instrument"](#), on page 22 for more information)
- One 5-pin plug for digital I/O port connection
- One 8-pin terminal block plug for output connection
- One Getting Started manual
- One document folder containing Basic Safety instructions guide, KC and CE certificate

4.1.4 Setting Up the Instrument

The R&S NGA100 is designed for benchtop and rackmount.

4.1.4.1 Bench Operation

On a benchtop, the R&S NGA100 can either lie flat or stand on its feet. The feet on the bottom can be folded out to set the instrument in an inclined position.

NOTICE**Positioning of instrument**

The instrument must be positioned in a manner that allows the user to disconnect the unit from the mains at any time and without restrictions.

4.1.4.2 Rack Mounting

The instrument can be installed in a 19" rack using the rack adapter R&S HZN96 (P/N 3638.7813.02). Proceed according to the installation instructions supplied with the rack adapter.

NOTICE**Ambient temperature**

Operate R&S NGA100 power supply in an area where the ambient temperature is within +5 °C to +40 °C. The R&S NGA100 power supply is fan-cooled and must be installed with sufficient space along the sides to allow proper air circulation. Ensure that fan openings are unobstructed and airflow vents are unimpeded.

Operating the instrument with insufficient airflow or outside the allowable ambient temperature can disrupt the operation and even cause damage.

4.2 Instrument Tour

This chapter provides an overview of all the controls available in the R&S NGA100 models and steps to switch on the instrument for the first time.

- [Overview of Controls](#).....18
- [Switching On the Instrument](#).....22

4.2.1 Overview of Controls**4.2.1.1 Front Panel**

The front panel of the R&S NGA100 is as shown in [Figure 4-1](#). The function keys and navigation controls are located at the right side of the display. The various connectors are located below the display and function keys.

The following power supply models are available:

Table 4-2: Power supply models

Models	Number of output channels
NGA101 (0 V - 35 V/6 A), NGA141 (0 V - 100 V/2 A)	1 (maximum 40 W)
NGA102 (0 V - 35 V/6 A), NGA142 (0 V - 100 V/2 A)	2 (maximum 80 W)

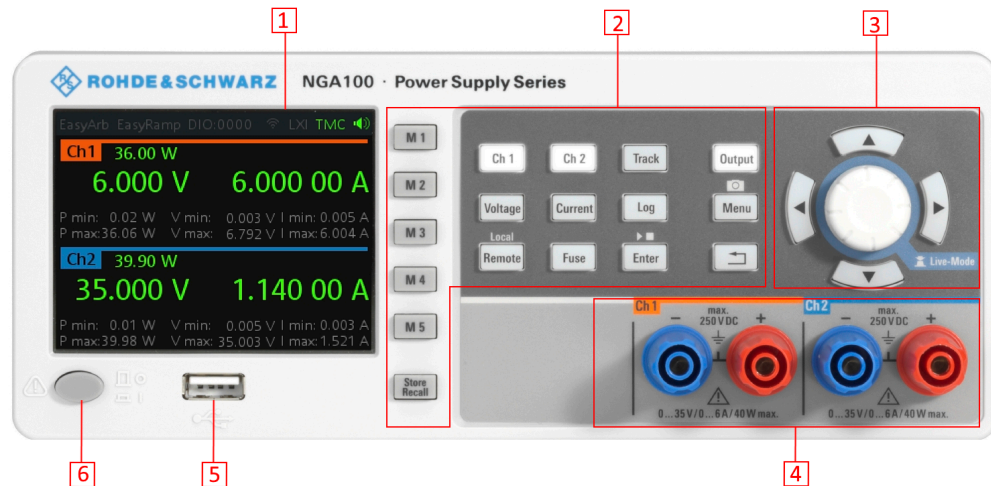

Figure 4-1: Front panel of R&S NGA100 with 2 channels

- 1 = Display
- 2 = Function keys
- 3 = Rotary knob and arrow keys
- 4 = Output channels (see Table 4-2)
- 5 = USB connector
- 6 = Power key

Display (1)

The display is a color LCD screen. Depending on the instrument models, up to two channels are shown on the screen. The respective measurement settings and functions are displayed in the individual channel section. There is a status bar above the channel section to indicate the functions used and operation mode of the instrument.

For a detailed description on-screen layout, see section "Screen Layout" in the User Manual.

Function keys (2)

Function keys are means of input for manual operation of the instrument functions. When a function key is pressed, all the related keys are also illuminated.

For detailed description on function keys, see section "Function Keys" in the User Manual.

Rotary knob and arrow keys (3)

Rotary knob and arrow keys are means of navigation and adjustment. When pressed or rotated, they perform tasks like navigation around the screen, adjustment of parameter values or confirmation of entries.

For detailed description on rotary knob and arrow keys, see section "Navigation Controls" in the User Manual.

Output channels (4)

Depending on the instrument models, up to two output channels are available for output of power to the connected load. See [Table 4-2](#).

USB connector (5)

USB Type-A connector is provided for connecting a USB flash drive to perform firmware update, data logging and store screen captures.

The USB flash drive file system supports FAT32 only.

Power key (6)

The [Power] key switches the instrument on and off.

4.2.1.2 Rear Panel

[Figure 4-2](#) shows the rear panel of the R&S NGA100 with its connectors.

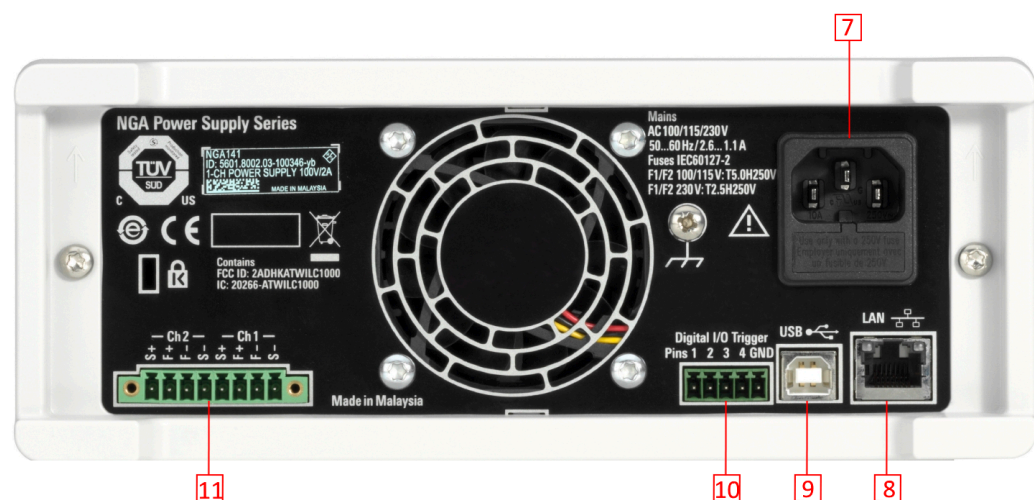

Figure 4-2: Rear panel of R&S NGA100

- 7 = AC inlet with fuse holder
- 8 = Ethernet (LAN) connector
- 9 = USB connector
- 10 = Digital I/O connector
- 11 = Rear panel connector

AC inlet with fuse holder (7)



Main supply cord

Do not use detachable mains supply cord with inadequate rating.

For safety reasons, the instrument can only be operated with authorized safety sockets.

The power cable must be plugged in before signal circuits can be connected. Never use the product if the power cable is damaged. See [Chapter 4.2.2, "Switching On the Instrument"](#), on page 22 for more information.

Ethernet connector (8)

This connector is used for establishing remote control via SCPI. See section "Ethernet Setup" in the user manual for more information on the connection setup.

USB connector (9)

The USB connector is a Type-B connector for remote control operation via USB TMC or USB VCP.

Digital I/O connector (10)

The Digital I/O connector is a 5-pin terminal block for external trigger input or output.

Measurement control can be achieved by means of an external input signal or as an output signal to trigger other instruments for some measurements.

The Digital Trigger I/O option (NGA-K103) must be installed for this function to be available in the instrument.

Rear panel connector (11)

DANGER

Shock Hazard

Do not turn on AC power when connecting wires to the rear panel connector.

Tightened all wires connected to the terminal block.

NOTICE

Output terminals

Either the output terminals at the front panel or the rear panel connector at the back panel can be used.

Both terminals should not be used at the same time as it can cause the instrument to malfunction.

The rear panel connector contains both output ("F+", "F-") and sense ("S+", "S-") connections. Connector for "Ch 2" is only available in the NGA102, NGA142 models.

4.2.1.3 Bottom Panel

The voltage selector is located at the bottom panel. On your first power-on connection, you should see a yellow label sticker attached over the [AC inlet](#). Before peeling off the

yellow label sticker, make sure that the correct fuse rating is used for the mains voltage.

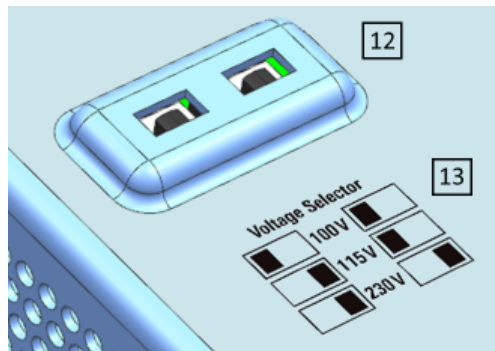

Figure 4-3: Bottom panel of R&S NGA100

12 = Voltage selector

13 = Voltage selector label

Voltage selector (12), Voltage selector label (13)

The voltage selector selects the mains voltage between 100 V, 115 V and 230 V. See [Table 4-1](#) for the fuse rating.

To set the correct fuse rating, use a tool e.g. a flat screwdriver to move the selector according to the voltage selector label.

- To select 100 V, slide both voltage selector to the left
- To select 115 V, slide both voltage selector facing inward
- To select 230 V, slide both voltage selector to the right

4.2.2 Switching On the Instrument

Before switching on the instrument, check that all the instructions in the “Basic Safety Instruction” brochure and safety measures in previous sections are observed.

Also, check if the value on the voltage selector corresponds to the mains voltage (100 V, 115 V or 230 V).

To change the power fuse / mains voltage setting:

1. Peel off the yellow label sticker on the AC inlet.
2. Pull out the fuse holder which is located directly on top of the socket.
3. Remove the preloaded fuses from the fuse holder.
4. Check the rating on the caps of both fuses that you want to change.
By default, the instrument is preloaded with two 230 V fuses.
For more information, see "[Voltage selector \(12\), Voltage selector label \(13\)](#)" on page 22.

5. Once verified, insert the fuses into each groove of the fuse holder.
6. Return the fuse holder to its position in the panel.

To switch on the instrument:

1. Connect the power cable to the AC power connector on the rear panel of the R&S NGA100.
2. Connect the power cable to the socket outlet.
3. Press [Power] key on the front panel.
The instrument performs a system check, boots the operating system and starts the R&S NGA100 firmware.
By default, all output channels are turned off when the instrument is switched on to prevent connected loads from being damaged unintentionally.
During startup, the R&S NGA100 is loaded with the last saved instrument settings from memory location "M1" and auto saved parameters. See [Chapter 6.12, "Store and Recall"](#), on page 55 in the User Manual.

To switch off instrument:

1. Press [Power] key.
2. Disconnect the AC power cable from the socket outlet.

4.3 Trying Out the Instrument

This chapter describes some basic functions that you can perform with the R&S NGA100.

4.3.1 Selecting the Channels

To select a channel, press the corresponding channel key. The key illuminates.

4.3.2 Setting the Output Voltage and Current Limit

To set the output voltage and current limit via Live-Mode:

1. Long press the rotary knob to enter into editing mode.
The voltage at channel 1 is highlighted in blue.
2. Move to the desired parameter via the arrow keys.
3. Rotate the knob to adjust its value.

Alternatively:

1. Press [Voltage] or [Current] key on the front panel.
2. For the two-channel R&S NGA100, press the desired channel key to activate the respective voltage or current limit setting of that channel. The value on the respective channel becomes editable and is positioned by a blue cursor.
3. Press the [Left] or [Right] arrow key to move the cursor.
4. Press the [Up]/[Down] arrow key or turn the rotary knob to change the value. The new value registers immediately.

4.3.3 Activating the Channels Output

The output voltages can be switched on or off regardless of the operating mode of the instrument.

To activate the channel output, press the [Output] key on the front panel followed by the desired channel key or vice versa.

For single channel models, press the [Output] key to activate the channel output.

Depending on the instrument operating mode, the display font color changes to green in CV (constant voltage) mode and red in CC (constant current) mode.

4.3.4 Storing/Recalling of Instrument Settings

The instrument settings can be stored in the instrument memory by long pressing the [Store Recall] key followed by the desired memory location key ([M1] to [M5]). The previous saved settings are overwritten.

To retrieve the settings, press [Store Recall] key and select the desired memory location key ([M1] to [M5]).

4.4 Maintenance and Support

4.4.1 Maintenance

Regular maintenance improves the life span of the instrument, the following chapter provides information on instrument maintenance.

Cleaning

Before cleaning the instrument, ensure that it has been switched off and the power cable is disconnected.

Clean the outer case of the instrument at regular intervals, using a soft, lint-free dust cloth.

NOTICE**Instrument damage caused by cleaning agents**

Use a dry, lint-free cloth to clean the product. When cleaning, keep in mind that the casing is not waterproof. Do not use any liquids for cleaning.

Cleaning agents, solvents (thinners, acetone), acids and bases can damage the front panel labeling, plastic parts and display.

The display may only be cleaned with an appropriate glass cleaner. Rub the display with a dry, clean and lint-free cloth. Do not allow cleaning fluid to enter the instrument.

4.4.2 Contacting Customer Support

Technical support – where and when you need it

For quick, expert help with any Rohde & Schwarz product, contact our customer support center. A team of highly qualified engineers provides support and works with you to find a solution to your query on any aspect of the operation, programming or applications of Rohde & Schwarz products.

Contact information

Contact our customer support center at www.rohde-schwarz.com/support, or follow this QR code:



Figure 4-4: QR code to the Rohde & Schwarz support page

5 Operating Basics

5.1 Display Overview

The following displays the screen layout of R&S NGA100. It shows the output voltage, current level and status bar information of the instrument.

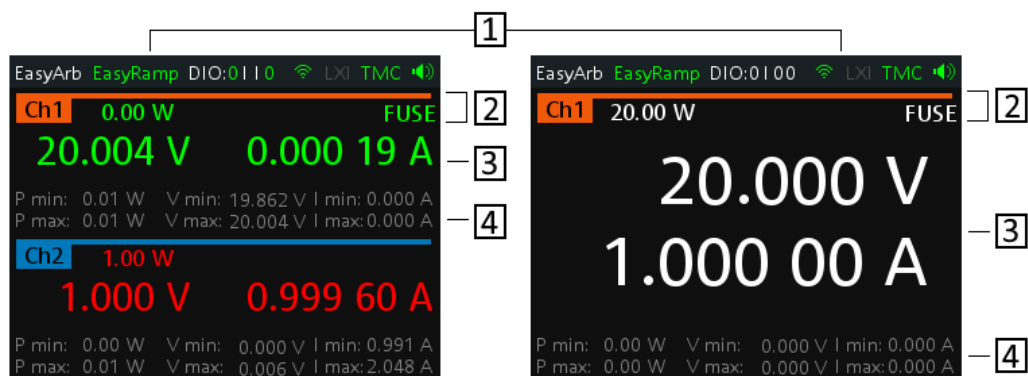

Figure 5-1: Screen layout of R&S NGA100 for two-channel and single channel display

- 1 = Device status bar
- 2 = Channel status bar
- 3 = Channel display area
- 4 = Channel history information

5.1.1 Status Bar Information

There are two types of status bar. One shows device status information and the other shows the individual channel status information.

Device status bar

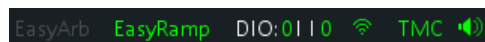



Table 5-1: Status bar function

Function	Description
EasyArb	Arbitrary output sequences on Ch 1. If in use, the icon is highlighted in green. If enabled, the icon is highlighted in white else it shows gray.
EasyRamp	Output voltage to ramp continuously within a 10 ms to 10 s until set voltage, V_{set} . If in use for any channel, the icon is highlighted in green else it shows gray.

Function	Description
DIO:xxxx	Digital Trigger I/O (Digital Trigger I/O option NGA-K103 must be installed). The "xxxx" refers to I/O status for DIO1, DIO2, DIO3, DIO4. If in use, the icon is highlighted in green. If enabled, the icon is highlighted in white. If disabled or option not installed, the icon is highlighted in gray.
	Wireless LAN connection (WLAN option R&S NGA-K102 must be installed). If connected to access point, the icon is highlighted in green. It shows yellow when connecting to access point. If disconnected or disabled, the icon is highlighted in gray.
TMC/VCP	USB connection with USB-VCP or USB-TMC setting. If TMC or VCP is selected, the icon is highlighted in green.
	Indicate buzzer state ("Disabled", "Fault Events", "Any Events"). If speaker is enabled, the icon is highlighted in green, else it shows gray.

Channel status bar

Ch1 0.00 W PAR SNS OVP OPP OTP FUSE

Function	Description
Channel number	Channel number indication.
Power	Display output power in watt.
SER/PAR	Indicator to show the series or parallel mode if channel fusion is enabled. Available only for the two-channel models. If enabled, the indicator displays in white.
SNS	Remote sense status indication. If enabled, the indicator displays in green.
OVP / OPP / OTP	Indicator to show that the overload voltage, power or temperature protection is triggered. When triggered, the indicator shows flashing and displays in red.
Fuse	Indicator to show the fuse status (on or off). When triggered, the indicator shows flashing and displays in red.

5.1.2 Channel Display Area

The R&S NGA100 displays two channels display area (Ch 1, Ch 2) for NGA102 and NGA142 and a single channel display area for NGA101 and NGA141. The respective channel settings and functions are displayed for each channel.

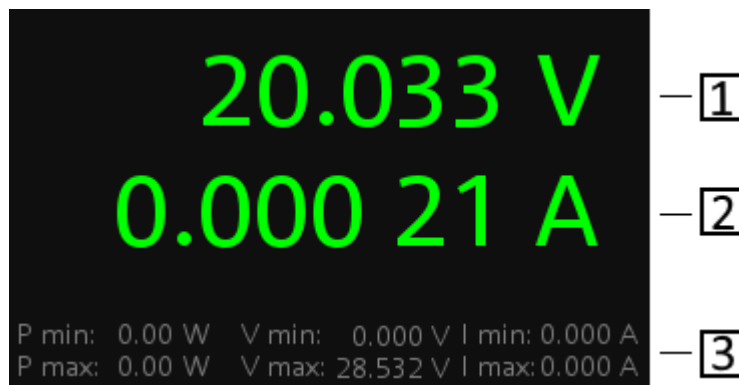

Figure 5-2: Channel display area for one-channel model

- 1 = Output voltage displays in volt. The display resolution for voltage is three digits after the decimal point
 2 = Output current displays in ampere. The display resolution for current is five digits after the decimal point
 3 = Channel history information displaying the historical maximum and minimum channel information (P min, P max, V min, V max, I min and I max)

Operating mode

Different font colors on the screen are used to differentiate the various output status and operating conditions of the instrument. It is easy to know and confirm the different output status and operating conditions of the instrument by looking at the colors.



Figure 5-3: Color coding of difference operating conditions

Color	Operating mode	Description
□	OFF mode	Output is OFF
■	Editing mode	A solid blue cursor is shown when an item is selected.
■	CV mode	Active outputs are operated in a constant voltage mode.
■	CC mode	Active outputs are operated in a constant current mode.

5.2 Front Panel Keys

For an overview of the front panel keys, see [Figure 4-1](#).

5.2.1 Function Keys

The keys can be categorized based on their functions.

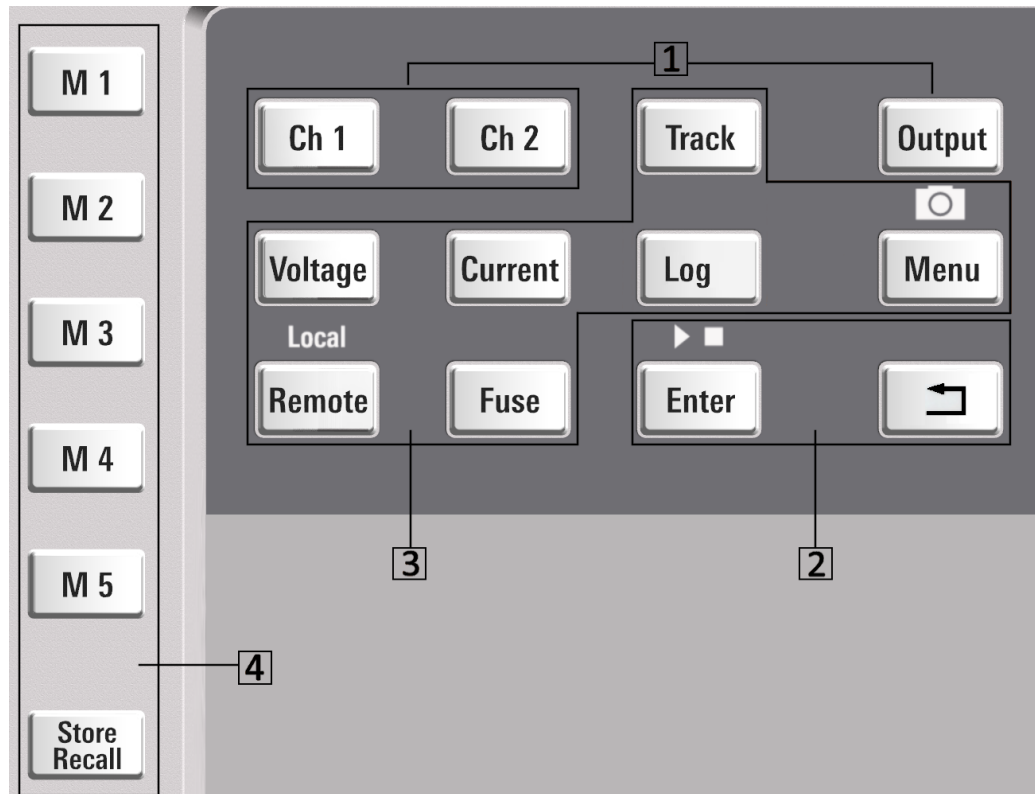

- 1 = Output and channel controls
- 2 = Navigation keys
- 3 = Instrument functions
- 4 = Memory functions

5.2.1.1 Output and Channel Controls

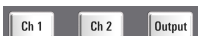



These keys control the channel output settings of the instrument.

Function keys	Description
[Ch 1], [Ch 2]	Selects the respective channel for output. Applicable only for the two-channel models See Chapter 6.1, "Setting the Channels Voltage and Current" , on page 38.
[Output]	Master output switch - it turns output for all selected channels on or off. See Chapter 4.3.3, "Activating the Channels Output" , on page 24

5.2.1.2 Navigation Keys

These keys provide navigation control in the instrument.

Function keys	Description
Enter 	Confirms menu selection or entry in dialog boxes. Start and stop (long press) the EasyArb function. See Chapter 6.11.1, "EasyArb" , on page 52.
Back 	Returns to the previous menu level or exit the menu mode. In the menu dialog, press the [Back] key to discard changes and restore the previous value. In the channel display area, press the [Back] key to exit editing mode and keep the changes made. Long press on the [Back] key resets the channel history information. See Figure 5-2 .

5.2.1.3 Instrument Functions

These keys control the channel output settings and instrument functions.

Function keys	Description
Voltage	Sets the output voltage for the channel. See "Set output voltage and current" on page 38.
Current	Sets the output current limit for the channel. See "Set output voltage and current" on page 38.
Track	Applicable only for the two-channel instrument models. Configures the tracking function. See Chapter 6.7, "Tracking Function" , on page 46.
Log	Toggles the data logging on/off. See Chapter 6.10, "Data Logging" , on page 51
Menu 	Main menu of the instrument. See Chapter 5.2.3, "Menu Key" , on page 32. Long press on [Menu] key to capture screenshot on the USB stick. The default screenshot filename starts with a prefix <code>nga100_scr_</code> followed by an ascending index 000-999 (e.g. <code>nga100_scr_001.bmp</code>).
Remote	Long press on [Remote] key to switch from remote to local control mode.
Fuse	Toggles the fuse on/off. See Chapter 6.6.1, "Fuse Delay, Fuse Linking" , on page 45.

5.2.1.4 Memory Functions

These keys are dedicated for a specific preprogrammed function.

Function keys	Description
M1 to M5	Five memory keys to save or recall instrument settings.
Store Recall	Saves/loads instrument settings. See Chapter 6.12, "Store and Recall" , on page 55.

5.2.2 Navigation Controls

Navigation and value setting are done via the rotary knob and arrow keys.

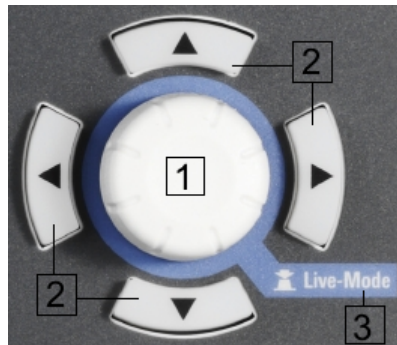

Figure 5-4: Navigation control

- 1 = Rotary Knob
- 2 = Arrow keys
- 3 = Live-mode

5.2.2.1 Rotary Knob



Step size changes of the numeric value correspond to the speed of the rotary knob.

The rotary knob has several functions depending on the mode it is in:

- Increments (clockwise direction) or decrements (counter-clockwise direction) any kind of numeric value when in editing mode.
- Navigates down (clockwise direction) or up (counterclockwise direction) the menu or menu items when rotated.
- Acts as an [Enter] key when pressed.
- Enter editing mode when pressed.
- Enter [Live-mode](#) when long pressed.

5.2.2.2 Arrow Keys

Using arrow keys, you can do several things:

- The up and down keys increase or decrease any kind of numeric value when in editing mode.
- Navigate through the menu or menu items in the dialog box.
- Long press on the up and down keys increase or decrease the numeric value of the menu items to maximum or minimum value in menu dialog (e.g. fuse dialog, protection dialog, EasyArb and EasyRamp dialog, etc)
To stop the increasing or decreasing of value, press the rotary knob.
- The left and right keys move the cursor in an input field in the corresponding direction.

5.2.2.3 Live-Mode

When the instrument goes into the Live-mode, all the arrow keys are illuminated.

The instrument automatically sets the Ch 1 voltage to editing mode. See [Figure 5-3](#). You can navigate to other channel settings by using the arrow keys to edit the voltage and current values.

The duration of Live-mode depends on the [key fallback time](#). Set a longer fallback time if you need more time in this mode.

To exit Live-mode, press the rotary knob.

5.2.3 Menu Key

The R&S NGA100 [Menu] key provides access to instrument's functions and general instrumental settings. You can also obtain the instrument and service information via the [Menu] key.

To access this mode:

1. Press [Menu] key on the front panel. The main menu screen appears.

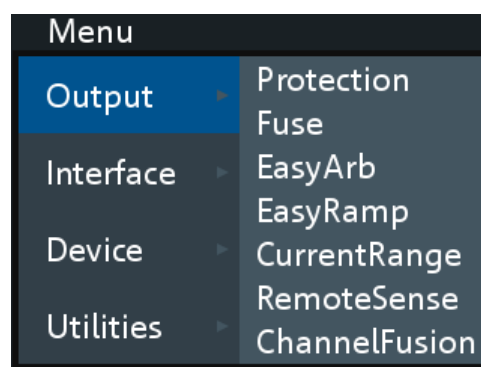

Figure 5-5: Main menu

2. Navigate the menu via the rotary knob or arrow keys.
3. Press the rotary knob or [Enter] key to enter the submenu.

- Press  key to return to the previous menu level or exit the menu mode if it is already at the main menu level. Alternatively, press [Menu] key to exit the menu mode from any menu level.

Table 5-2: Main menu hierarchy

Menu	Descriptions
Output	Menu items related to the instrument's output functions.
Interface	Menu items related to connection setup.
Device	Menu items related to the instrument's general settings, reset function and information about the instrument.
Utilities	Menu items such as system test, firmware update function and information for service.

Table 5-3: Output menu hierarchy

Menu	Menu items	Descriptions
Output	Protection	Configures the OVP and OPP protection settings for the instrument. See Chapter 6.8, "Protection" , on page 46.
	Fuse	Configures the fuse delay and fuse linking function of the channel. See Chapter 6.6.1, "Fuse Delay, Fuse Linking" , on page 45.
	EasyArb	Programs the waveform of the instrument voltage and current settings for Ch 1. See Chapter 6.11.1, "EasyArb" , on page 52.
	EasyRamp	Configures the ramping time of the voltage for selected channel. See Chapter 6.11.2, "EasyRamp" , on page 54.
	CurrentRange	Configures the current range used for readback measurement. See Chapter 6.3, "Current Range" , on page 40.
	RemoteSense	Configures the voltage compensation on cables connected to the load. See Chapter 6.4, "Remote Sense Function" , on page 41.
	ChannelFusion	Configures the channel fusion mode. See Chapter 6.5, "Channel Fusion" , on page 42.

Table 5-4: Interface menu hierarchy

Menu	Menu items	Descriptions
Interface	Ethernet	Configures the Ethernet interface. See Figure 6-15 .
	WLAN	Configures the WLAN interface. See Figure 6-16 . The WLAN option NGA-K102 must be installed for this function to be available in the instrument.

Menu	Menu items	Descriptions
	Digital IO	Configures the Digital Trigger I/O settings. See Figure 6-10 . The Digital Trigger I/O option NGA-K103 must be installed for this function to be available in the instrument.
	USB	Configures the USB connection. See Figure 6-18 . Requires restart of the instrument to apply the setting.

Table 5-5: Device menu hierarchy

Menu	Menu items	Descriptions
Device	Information	Displays instrument information. See Chapter 6.14.1, "Instrument Information" , on page 66.
	General	Configures general instrument settings. Chapter 6.14.2, "General Instrument Settings" , on page 67.
	License	Displays license information and install license options. See Chapter 6.14.3, "Managing Options" , on page 67.
	Reset	Resets instrument to factory default settings. See Chapter 6.14.4, "Reset Instrument" , on page 68.

Table 5-6: Utilities menu hierarchy

Menu	Menu items	Descriptions
Utilities	System Test	Provides self-test function for display screen, keypad back-light, beeper and fan. See Chapter 6.14.5, "System Test" , on page 70.
	Update	Performs firmware update on the instrument. See Chapter 6.14.6, "Updating the Firmware" , on page 70.
	Service	This function is restricted for service personnel only.
	Date Time	Configures system date and time. See Chapter 6.14.8, "Date Time" , on page 72.
	Help	Provides help information for the instrument. See Chapter 6.14.7, "Help" , on page 72.





5.3 On-screen Keyboard

The on-screen keyboard allows you to input symbols and alphanumeric characters in the input field. It can be invoked whenever there is an input field.



Figure 5-6: Virtual keyboard

Invoke the on-screen keyboard as follows:

1. Move the cursor to the desired input field.
2. Press [Enter] key. The on-screen keyboard appears.
3. Once on the keyboard screen, press the arrow keys or turn the rotary knob to go to the desired character.
4. Press the rotary knob to select the character.
 - Select  key if you want to create a space between characters.
 - To delete the last entered character, select the  key.
 - To delete the current entry, select the  key.
 - Select the  key to alternate between capital and small capital letters.
5. Repeat step 3 and 4 until all the characters are entered.
6. Select "OK" to confirm the input and exit the screen.
 - Select "ESC" or press [Menu] key to exit the screen without saving the changes.

5.4 Power Derating

The R&S NGA100 power supply series provides a maximum output power of 40 W for a single channel model. Depending on the power supply models, up to 80 W of output power is provided for models with two identical channels with a continuous voltage range of 0 V to 35 V or 0 V to 100 V.

Combination of the set voltage and current limit results in the following output performance graph.

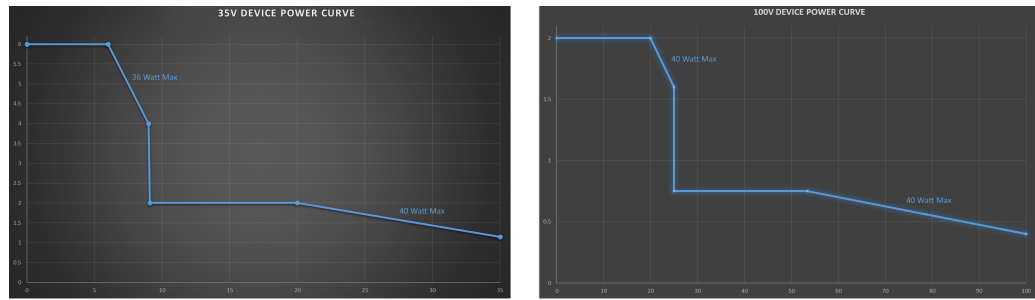

Figure 5-7: Output performance graph

According to the basic electrical formula for power ($P = I \times V$), the following results for the maximum power per channel:

- NGA101, NGA141: 40.0 W for single channel
- NGA102, NGA142: 40.0 W per channel (80 W max for the combination of two channels)

For more information on the combination of channels, see [Chapter 8.1, "Parallel and Series Mode"](#), on page 108.

5.5 Operation Modes

The R&S NGA100 operates in two different modes, i.e. CV and CC. The instrument switches automatically between CV and CC depending on the connected load.

CV mode

[Figure 5-8](#) shows that if the instrument is in the range of voltage regulation, the output voltage V_{out} remains constant while the current may increase to its maximum value I_{max} when the connected load is increasing. In CV mode, the font text in the channel display area changes to green.

See [Figure 5-3](#)

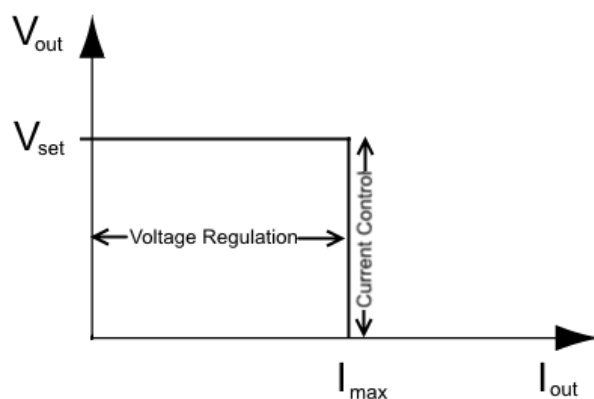

Figure 5-8: Current limit

CC mode

The current I_{max} corresponds to the current setting adjustable in the instrument.

If I_{out} reaches I_{max} , the instrument switches to CC mode, i.e. the output current remains constant and limited to I_{max} even if the load increases. Instead, the output voltage V_{out} decreases below V_{set} . In a short circuit, the output voltage drops towards zero. In CC mode, the font text in the channel display area changes to red.

See [Figure 5-3](#)

6 Instrument Functions

6.1 Setting the Channels Voltage and Current

The R&S NGA100 comes with the following instrument models:

Model	Voltage	Current
NGA101, NGA102	0 V to 35 V	<= 6 V: 6A > 6 V to 9 V: 40 W > 9 V to 20 V: 2 A > 20 V to 35 V: 40 W
NGA141, NGA142	0 V to 100 V	<= 20 V: 2 A > 20 V to 25 V: 40 W > 25 V to 54 V: 0.75 A > 54 V to 100 V: 40 W

Depending on models, toggle the respective channel key ([Ch 1] or [Ch 2]) on the front panel to select these channels. When a channel is selected, the respective channel key illuminates. See [Figure 6-1](#).



Figure 6-1: Ch 1 key illuminates when selected

Set output voltage and current



Voltage, current settings

If "Arbitrary" function of a Ch 1 is enabled, the channel voltage or current setting is disabled.

See "[EasyArb function](#)" on page 52.

Depending on the instrument models, the R&S NGA100 adjusts the voltage and current values with the following step size.

NGA101, NGA102	NGA141, NGA142
1 mV	10 mV
1 mA	1 mA

The setting of current value corresponds to the I_{max} of the respective channel. It is advisable to set the current limit before operating the instrument to prevent damage to the load and instrument in the case of malfunction like short-circuit.

1. Press [Voltage] or [Current] key.
The previous set channel is selected.
The channel font changes to blue and all the navigation controls illuminate.
Selected [Voltage] or [Current] key and the channel key are also illuminated.
2. Press the desired channel key to switch to that channel.
Selected channel key ([Ch 1], [Ch 2]) illuminates.
3. Enter the desired voltage or current value.
4. Press the rotary knob, [Voltage]/[Current] or [Enter] key to confirm the value.
The selected channel font text changes to yellow.

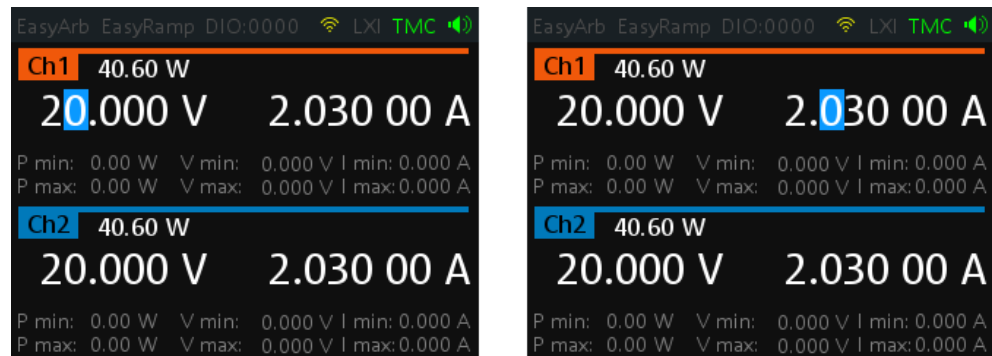

Figure 6-2: Voltage and current settings in the instrument

See [Chapter 5.2.2.3, "Live-Mode"](#), on page 32 for alternative way to configure the voltage and current values.

See also [General Instrument Settings](#) on the keypad for setting the fallback time.

6.2 Activating the Channel Output

Depending on the models, the outputs of the channels (Ch 1, Ch 2) can be switched on or off by toggling the [Output] key on the front panel.

By default, the output is turned off when the instrument is switched on.

1. For two-channel models, press the required channel key.
Selected channel key (Ch 1, Ch 2) illuminates.
2. Press [Output] key.
The R&S NGA100 outputs the set voltage on the channel.
Depending on the operating mode, the font text in the channel display area shows green in CV mode and red in CC mode.
See [Chapter 5.5, "Operation Modes"](#), on page 36.
See also [Chapter 5.4, "Power Derating"](#), on page 35.

Multiple outputs can be turned on or off at the same time.

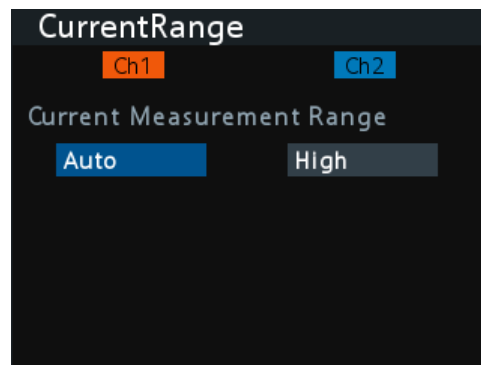

Figure 6-3: Output of Ch2 in CC mode

6.3 Current Range

The "CurrentRange" dialog provides the configuration to set the measured output current range.

1. Press [Menu] key on the front panel.
The main menu screen appears.
2. Select "Output" > "CurrentRange" menu item to configure current range setting.
The R&S NGA100 displays the "CurrentRange" dialog.



3. Set the required current range for respective channel.
 - "High": The measured output current is displayed in "A" with 10 μ A resolution
 - "Low": The measured output current is displayed in "mA" with 1 μ A resolution
If output current exceeds 200 mA, the "OVLD" information is displayed
 - "Auto": The measured output current is displayed in the following:
 - "A" with 10 μ A resolution for current above 200 mA
 - "mA" with 1 μ A resolution for current below 200 mA



"High" current readback range is tested for 100 μ A resolution per specification.



To avoid oscillation in "Auto" mode, the "Low" range to "High" range switching point is at 210 mA and the "High" range to "Low" range switching point is at 170 mA.

Example:

The following shows the displays of current range set to "High" for Ch 1 and "Low" for Ch 2.

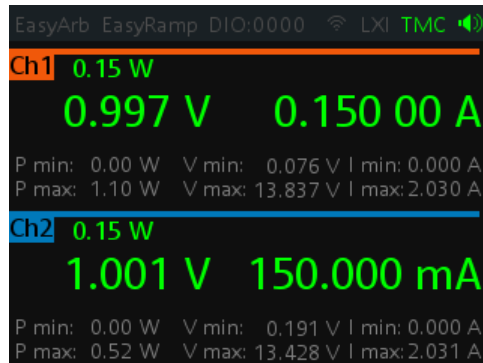

If output current has exceeded 200 mA when current range is set "Low", the "OVLD" information is displayed.

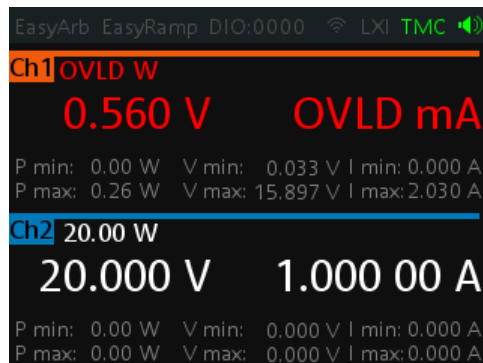

6.4 Remote Sense Function

The "Remote Sense" is a mechanism used to monitor and compensate the voltage drops on the cables connected to the load.

1. Press [Menu] key.
2. Select "Output" > "Remote Sense" menu item to configure the remote sense mode. The R&S NGA100 displays the "Remote Sense" dialog.

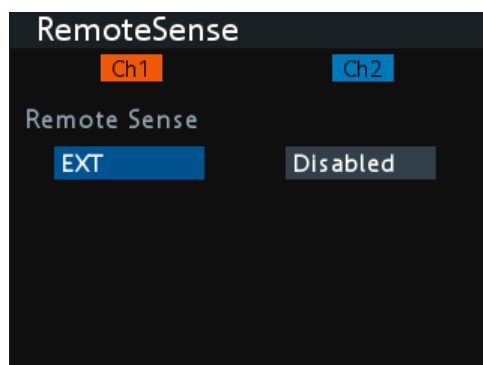

3. Select the required remote sense mode for selected channels.
 - "EXT": The internal voltage sense relay in the instrument is switched on and the connection of remote sense wires (S+, S-) to the input of the load become necessary. Failure to connect remote sense can cause overvoltage or unregulated voltage output from the R&S NGA100. The voltage sense relay remains switched on even when output is turned off.
 - "Disabled" : Remote sense connection is disabled.

6.5 Channel Fusion

The "ChannelFusion" provides configuration to set the connection mode (series or parallel) of the device. The R&S NGA100 has an internal series link to connect Ch 1 and Ch 2 if series mode is configured.

The device operates as a 1-channel device which combines both Ch 1 and Ch 2 output.

For more information, see [Chapter 8.1, "Parallel and Series Mode"](#), on page 108.



The "ChannelFusion" is available only in the two-channel models.

1. Press [Menu] key on the front panel.
The main menu screen appears.
2. Select "Output" > "ChannelFusion" menu item to configure channel fusion mode.
The R&S NGA100 displays the "ChannelFusion" dialog.

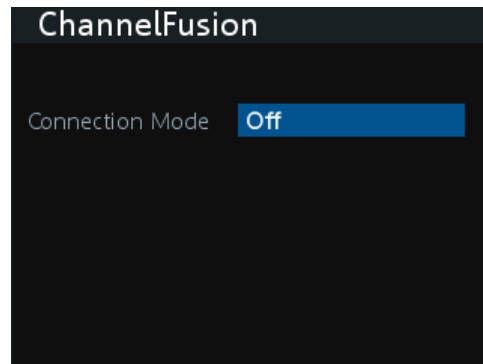

3. Set the required channel fusion mode:
 - "Off": Channel operates separately
 - "Series": In series mode, the two terminals in the middle are used for output. There is an internal series link activated to connect channel 1 and channel 2 output. If this series mode is set, a "SER" indicator is displayed on the channel status bar. For details, see [Chapter 8.1.1, "Series Mode"](#), on page 108

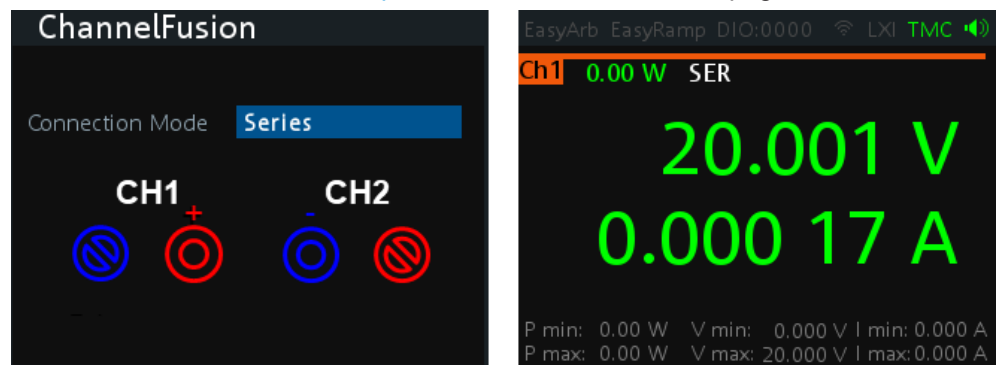

Figure 6-4: Series mode setting and output of one-channel display

Note: The "Digital IO", "EasyArb" and "EasyRamp" functions are disabled in this mode.

- "Parallel": In parallel mode, an external wire is required to connect the "CH1" and "CH2" terminals. All channels can be used as output. If parallel mode is set, a "PAR" indicator is displayed on the channel status bar. See ["Channel status bar"](#) on page 27.

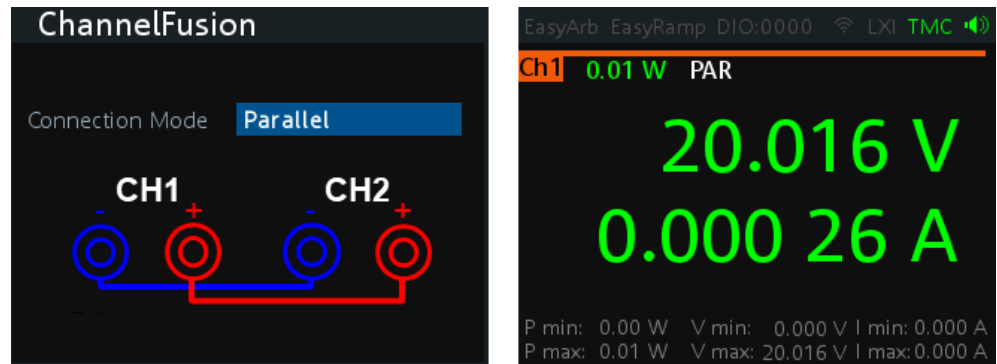

Figure 6-5: Parallel mode setting and output of one-channel display

See also [Chapter 8.1.2, "Parallel Mode"](#), on page 109.

Note: The "Digital IO", "EasyArb", "EasyRamp" and "CurrentRange" functions are disabled in this mode.

6.6 Activating Fuse

To protect a connected, sensitive output in general, the R&S NGA100 power supply includes an electronic fuse which can be switched on individually for each channel.

A fuse delay can be applied to each channel and individual electronic fuses can be logically linked to switch off the interlinked channels if a fuse triggers.

For more information, see [Chapter 6.6.1, "Fuse Delay, Fuse Linking"](#), on page 45 for fuse delay and fuse linking configuration.

1. Turn off the output before activating the fuse for each channel.
2. Press [Fuse] key.
The R&S NGA100 activates the fuse function and the [Fuse] key illuminates.
Activated fuses are also illuminated on channel keys for the two-channel models.
3. For the two-channel models, press the desired channel to activate or deactivate the fuse.
For the single-channel models, toggle the [FUSE] key to activate or deactivate the fuse.
Selected channel key ([Ch 1], [Ch 2]) illuminates.
On the channel display area, the "FUSE" is indicated on selected channels.
4. Repeat step 1 and step 2 to disable the fuse function.

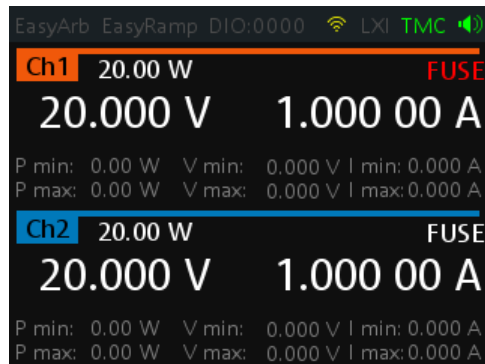

Figure 6-6: Fuse indicator on respective channel

6.6.1 Fuse Delay, Fuse Linking

The fuse delay and fuse linking functions provide the flexibility to handle a fuse tripped event when it occurs. When a fuse tripped event triggered, the affected channels are turned off according to the settings configured in the fuse delay and fuse linking.

With fuse delay function, it allows you to ignore the current peaks set above the current limit that occurs during the time set in the fuse delay. This prevents the fuse to be triggered in case of a capacitive load.

With fuse linking function, it allows you to logically interlink channels with their electronic fuses. If a fuse trips during operation, all channels interlinked with this channel are turned off.

See [Chapter 6.6, "Activating Fuse"](#), on page 44 for more information.

1. Press [Menu] key.
2. Select "Output" > "Fuse" menu item.
The R&S NGA100 displays the "Fuse" dialog. See [Figure 6-7](#).

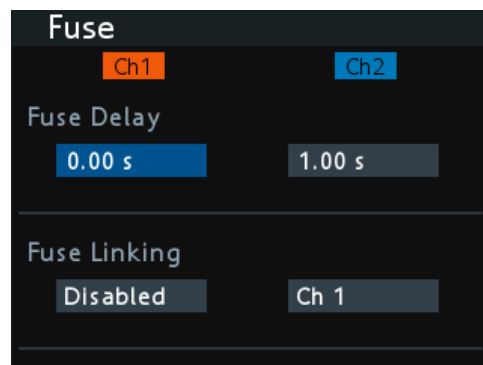

Figure 6-7: Fuse dialog

3. Set "Fuse Delay" to a desire value.
You can set a value from 0 s to 10 s in a 0.01 s step size.

- Configure the "Fuse Linking" setting.

The R&S NGA100 provides the following options:

Example for "Ch 1", the available options are as follows:

- "Ch 2": "Ch 2" is linked to "Ch 1". If "Ch 1" fuse tripped, "Ch 2" is turned off.
- "Disabled": "Ch 1" is not linked to any other channels.

6.7 Tracking Function



Applicable only to NGA102 and NGA142 power supply models.

For power supplies with multiple channels, the channels can be linked such that changes made on the selected tracked channel is applied to other channel.

- Press [Track] key.
The R&S NGA100 activates the tracking function and the [Track] key illuminates.
- Press the tracked channel to be tracked.
The selected tracked channel key ([Ch 1] or [Ch 2]) illuminates.
- Press [Current] key if current values should be tracked.
All the channels are highlighted in blue and all the navigation controls illuminate. Selected [Voltage] or [Current] key is also illuminated.
- Set the desired voltage or current value.
Use the arrow keys or rotary knob to enter the value. All tracked channels voltage or current are changed by the same amount.

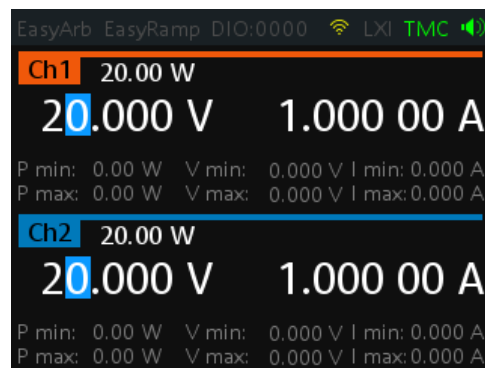

6.8 Protection

The R&S NGA100 provides individual overvoltage protection (OVP) and overpower protection (OPP) settings for each channel. With both function activated, the R&S NGA100 protects itself and the load in case of voltage or power overloads.

If protection is tripped, a red flashing OVP or OPP indicator is displayed on the respective channel. See [Figure 6-8](#).

A beep is sounded if buzzer is enabled. See [Figure 6-21](#).



Figure 6-8: Indicator of OVP/OPP when tripped

1. Press [Menu] key.
2. Select "Output" > "Protection" menu item.
The R&S NGA100 displays the "Protection" dialog. See [Figure 6-9](#).

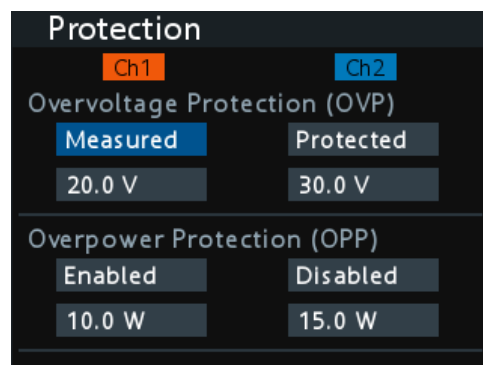

Figure 6-9: Protection dialog

3. Set the OVP mode for the desired channel.
The available options are as follows:
 - "Measured": The output is switched off if the measured value exceeds the set limit. Switching on the channels triggered the OVP if the condition remains.
 - "Protected": The output is disabled if the setting exceeds the set limit.
 - "Disabled": OVP is set to maximum value supported by hardware. See the R&S NGA100 brochure for the instrument specification.
4. Set the desired voltage for OVP.
The R&S NGA100 turns off the respective channel when the measured voltage exceeded the preset value.
5. Set the OPP mode for the desired channel.

The available options are as follows:

- "Enabled": The channel is turned off if the measured power exceeds OPP value.
- "Disabled": Depending on models, output power is limited to maximum value of 40 W (NGA101, NGA102) or 80 W (NGA141, NGA142).

6. Set the desired power for OPP.

The R&S NGA100 turns off the respective channel when the measured power exceeded the preset value.

6.9 Digital Trigger I/O

CAUTION

Digital I/O Pins Voltage Rating

Do not exceed the maximum voltage rating of the Digital I/O pins (5.25 V max) when supplying voltages to the pins.



R&S NGA-K103 (order number: 5601.8425.99) option is required for the Digital Trigger I/O.

The four data lines of the digital I/O interface are mutually independent and can be used as trigger input or trigger output separately. See [Figure 4-2](#).

- Trigger input
The data lines of the digital I/O interface receive external trigger signal. The external trigger signal triggers the selected channel (Ch 1, Ch 2) with the set response when the trigger condition (Active High or Active Low) is met.
- Trigger output
The data lines of the digital I/O interface output an "Active Low" or "Active High" signal when the trigger condition of the selected channel is met.

Table 6-1: Trigger in parameters and conditions

Trigger in parameters	Trigger conditions		Description
Channel	Ch 1, Ch 2		Target output channel selected for trigger response.
Response Trigger	Output On	Level	Selected channel [Output] is enabled when the selected logic level is met.
	Output Off	Level	Selected channel [Output] is disabled when the selected logic level is met.
	Output Toggle	Pulse	Selected channel [Output] is toggled when the selected logic pulse is met.

Trigger in parameters	Trigger conditions		Description
	Output Inhibit	Level	Selected channel [Output] is inhibited when the selected logic level is met. When the selected channel [Output] is put to inhibit state, manual or remote operation on selected channel [Output] is no longer possible. To reverse the inhibit state, remove the source of the trigger signal. You can either disable the affected DIO interface or remove the source from the affected DIO interface at the rear panel.
	Start EasyArb (Only for Ch 1)	Level	Activates the EasyArb function on channel 1 when the selected logic level is met. The EasyArb is deactivated when the level changes (i.e from active high to active low) See Chapter 6.11.1, "EasyArb" , on page 52.
		Pulse	Activates the EasyArb function on channel 1 when the selected pulse is met. See Chapter 6.11.1, "EasyArb" , on page 52.
Logic	Active High		Set the logic level of the trigger in signal.
	Active Low		

Table 6-2: Trigger out parameters and conditions

Trigger out parameters	Trigger conditions		Description
Channel	Ch 1, Ch 2		Output channel selected to monitor for trigger condition.
Condition Trigger	Output On		Output the selected logic level when the [Output] is turned on at the selected channel.
	Output Off		Output the selected logic level when the [Output] is turned off at the selected channel.
	Fuse Tripped		Output the selected logic level when a fuse tripped event occurs on the selected channel. See Chapter 6.6, "Activating Fuse" , on page 44 and Chapter 6.6.1, "Fuse Delay, Fuse Linking" , on page 45.
	CC Mode		Output the selected logic level when the selected channel operates in the CC mode. See "CC mode" on page 37.
	Voltage Level	>= "set value"	Output the selected logic level when the voltage level of the selected channel is greater or equal to the set level.
	Current Level	>= "set value"	Output the selected logic level when the current level of the selected channel is greater or equal to the set level.

Trigger out parameters	Trigger conditions		Description
	Critical Event	OVP	Output the selected logic level when the selected critical event (OVP, OPP, OTP) occurs on the selected channel. See Chapter 6.8, "Protection" , on page 46.
		OPP	
OTP			
	EasyArb Active		Output the selected logic level when the EasyArb function is running on channel 1. See Chapter 6.11.1, "EasyArb" , on page 52. Note: For a reliable DIO trigger output, the EasyArb waveform needs to be at least 200 ms.
Logic	Active High		Set the logic level of the trigger out signal.
	Active Low		

To setup the DIO for usage, you have to enable the required DIO and "Master Enable" parameters:

Note: After a recall function, the "Master Enable" is disabled, see ["Recall instrument settings"](#) on page 57.

1. Press [Menu] key.
2. Select "Interface" > "Digital IO" menu item.
The R&S NGA100 displays the "Digital IO" dialog. See [Figure 6-10](#).

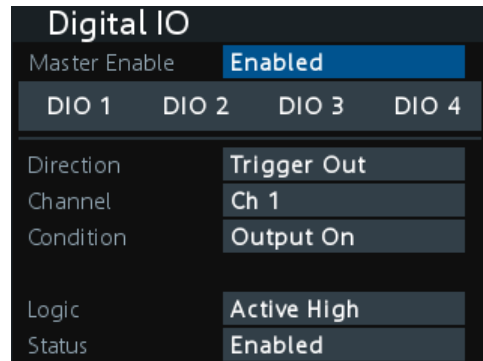

Figure 6-10: Digital IO dialog

3. Select the desired DIO interface.
4. Select "Trigger In" to accept external trigger signal or "Trigger Out" to output the trigger signal.
5. Set the desired "Channel".
6. Select the desired trigger condition.
See [Table 6-1](#) and [Table 6-2](#).
7. Set the desired "Logic" state.
8. Set the "Status" to "Enabled".

The R&S NGA100 enabled the selected DIO interface and monitor or feedback the trigger condition on the selected channel.

- Set the "Master Enable" to "Enabled".
The "Master Enable" is the master DIO interface which activates or deactivates all the DIO interfaces.

6.10 Data Logging

The data logging function provides the logging of data to external USB storage.

- Attached a USB storage to the USB connector on the front panel.
- Press [Log] key on the front panel.
The R&S NGA100 starts the data logging.
An indicator "Logging started" is displayed on the status bar, the [Log] key is also illuminated when data logging starts.
The data is stored in the file named `log-yyyymmddTHHmss.csv` , e.g. `log-19701231T235501.csv`. See [Figure 6-11](#).

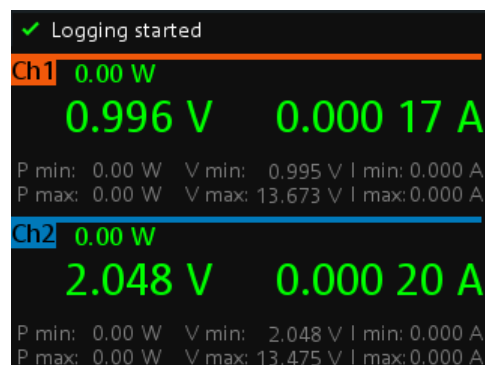

- Toggle the [Log] key to stop data logging.
The R&S NGA100 finishes the data logging.
An indicator "Finish writing to usb" is displayed on the status bar.



#Device	NGE100					
#Device	NGE100					
#Format	LOG					
#Date	1/1/2019					
#Version	1.016 0032AAA29					
#Logging	0.1					
Timestamp	U1[V]	I1[A]	P1[W]	U2[V]	I2[A]	P2[W]
05:33.8	0.996	0.00018	0	2.048	0.0002	0
05:33.9	0.996	0.00018	0	2.048	0.0002	0
05:34.0	0.996	0.00017	0	2.048	0.0002	0
05:33.1	0.996	0.00017	0	2.048	0.0002	0
05:33.2	0.996	0.00017	0	2.048	0.00018	0
05:33.3	0.996	0.00017	0	2.048	0.00019	0
05:33.4	0.996	0.00017	0	2.048	0.0002	0
05:33.5	0.996	0.00017	0	2.048	0.0002	0
05:33.6	0.996	0.00018	0	2.048	0.0002	0
05:33.7	0.996	0.00018	0	2.048	0.0002	0
05:33.8	0.996	0.00017	0	2.048	0.0002	0
05:33.9	0.996	0.00017	0	2.048	0.00019	0
05:35.0	0.996	0.00017	0	2.048	0.00021	0
05:34.1	0.996	0.00018	0	2.048	0.00021	0
05:34.2	0.996	0.00016	0	2.048	0.00021	0
05:34.3	0.996	0.00017	0	2.048	0.00021	0
05:34.4	0.996	0.00016	0	2.048	0.00021	0
05:34.5	0.996	0.00017	0	2.048	0.00022	0
05:34.6	0.996	0.00017	0	2.048	0.00021	0
05:34.7	0.996	0.00017	0	2.048	0.0002	0
05:34.8	0.996	0.00017	0	2.048	0.00021	0
05:34.9	0.996	0.00017	0	2.048	0.00021	0
05:36.0	0.996	0.00016	0	2.048	0.00021	0
05:35.1	0.996	0.00017	0	2.048	0.00021	0
05:35.2	0.996	0.00017	0	2.048	0.0002	0
05:35.3	0.996	0.00017	0	2.048	0.0002	0
05:35.4	0.996	0.00018	0	2.048	0.00021	0
05:35.5	0.996	0.00018	0	2.048	0.0002	0
05:35.6	0.996	0.00017	0	2.048	0.00021	0

Figure 6-11: Log data sample

6.11 Advanced Functions

The following chapters provide information about the [EasyArb](#) and [EasyRamp](#) menu items found in the [Menu] key.

1. Press [Menu] key.
The R&S NGA100 displays the main menu of the instrument.
See [Chapter 5.2.3, "Menu Key"](#), on page 32.
2. Select the "Output" menu item.
The R&S NGA100 displays the respective menu item dialog.

6.11.1 EasyArb



EasyArb function

The arbitrary function is available only in Ch 1.
See ["Voltage, current settings"](#) on page 38.



LabVIEW driver

The arbitrary functions in LabVIEW driver rshmc804x do not support the EasyArb feature in the R&S NGA100.

The R&S NGA100 series allows you to generate freely programmable waveforms which can be reproduced within the limits set by the instrument for voltage and current.

1. Select "EasyArb" menu item.

The R&S NGA100 displays the "EasyArb" dialog. See [Figure 6-12](#).

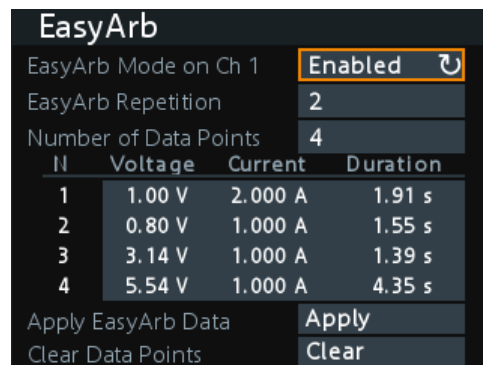

Figure 6-12: EasyArb dialog

2. Set "EasyArb Mode on Ch 1" to "Enabled".
The R&S NGA100 enabled the EasyArb function for Ch 1.
Note: If "EasyArb Mode" is set disabled, corresponding output state of Ch 1 is also disabled.
3. Set the desired repetition cycle for the EasyArb function.
4. Set the desired data points for the EasyArb function.
The R&S NGA100 displays the number of EasyArb entry points in the EasyArb table.
5. Configure the EasyArb table with the desired values for voltage, current and duration.
6. Select "Apply" to save the EasyArb settings.
The EasyArb data points are sent to Ch 1.
7. Select "Clear" to reset the EasyArb table values.
All the EasyArb data points are cleared from Ch 1.
See [Table 6-3](#).
8. Press [Menu] key to return to the [Channel Display Area](#).
The [Enter] key is illuminated.
9. Press [Output] key to enable the R&S NGA100 output.
10. Press [Enter] key to start the EasyArb function.
11. Long press on the [Enter] key to stop the EasyArb function.

Table 6-3: EasyArb input field

EasyArb input field	Description
EasyArb mode	Enable or disable the EasyArb function. If enabled, the EasyArb function is activated in Ch 1. See "EasyArb function" on page 52.
Data points	Set the number of data points in the EasyArb table. Each data point contains the settings for "Voltage", "Current" and "Duration".
Repetition	Set the number of times the waveform is output in the EasyArb table. If this is set to "0", the waveform is output continuously.
EasyArb table	Configures the EasyArb data table. Use the arrow keys to navigate the "Voltage", "Current" and "Duration" settings.
Clear	Reset all the data points in the EasyArb table to 0.00 V, 1.000 A and 0.01 s for "Voltage", "Current" and "Duration" respectively.
Apply	Select "Apply" to save EasyArb configuration.

6.11.2 EasyRamp

With EasyRamp, the R&S NGA100 provides you the operating condition to output a constant rise of the supply voltage. The output voltage can be increased continuously within a 10 ms to 10 s timeframe. See Figure 6-13.

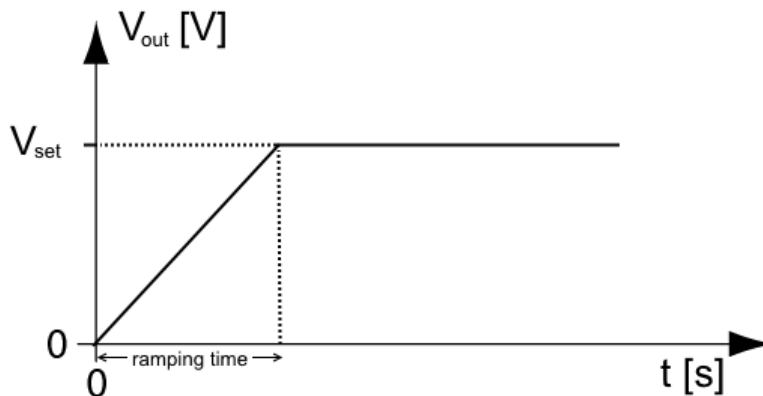

Figure 6-13: Ramping voltage output

1. Select "EasyRamp" menu item.
The R&S NGA100 displays the "EasyRamp" dialog. See Figure 6-14.

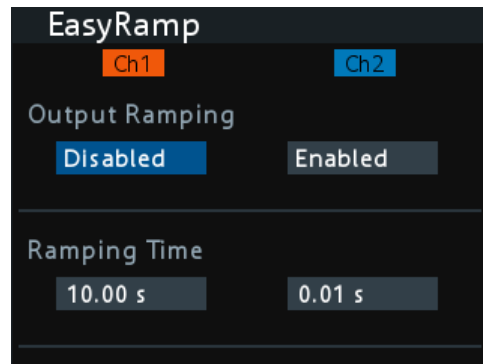

Figure 6-14: EasyRamp dialog

2. Select the desired channel.
3. Set the selected channel to "Enabled".
The R&S NGA100 enabled the EasyRamp function for the selected channel.
Note: If selected channel is set disabled, corresponding output state of the selected channel is also disabled.
4. Set the "Ramping Time" of the selected channel.
5. Press [Enter] key to confirm the settings.

Table 6-4: EasyRamp input field

EasyRamp input field	Description
"Output Ramping"	Enable or disable the EasyRamp function individually for each channel.
"Ramping Time"	Duration taken for the voltage to rise to V_{set} .

6.12 Store and Recall



Upon power-up, the instrument loads the stored setting from memory location M1 with the exception on EasyArb parameters. Auto saved parameters are also applied during startup.

The R&S NGA100 output state of all channels (Ch 1, Ch 2) is disabled when the recall function is activated.



Auto save instrument settings

Auto save of instrument settings are applied when any of the following parameters changed:

- [General instrument settings](#)
- [USB connection mode](#)
- [WLAN settings](#)
 - "Module"
 - "SSID"
 - "Password"
- Ethernet

The instrument settings can be stored or recalled from memory locations M1 to M5.

The following instrument settings are stored or recalled in the memory location:

- [Fuse settings](#)
- [Protection settings](#)
- [EasyRamp settings](#)
- Set voltage level
- Set current level
- ¹[EasyArb settings](#)
- ¹[Digital IO settings](#)

¹The EasyArb or DIO settings can only be saved in the respective dialog environment and all other above instrument settings are not saved when a store function is made.

When a recall function is made on the same stored memory location, only the EasyArb or DIO settings are recalled.

Store instrument settings

1. Long press [Store Recall] key to store instrument settings.

The R&S NGA100 displays a message in the status bar "Store device settings: select any [Mx] key".

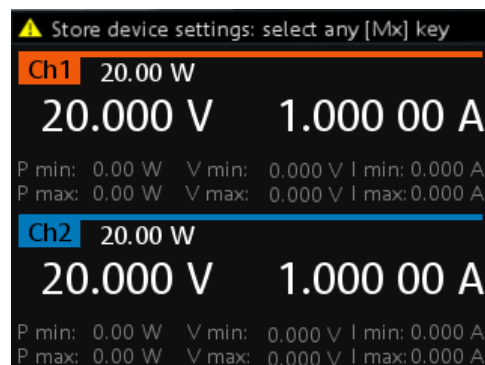

- Press any of the memory keys ([M1],[M2], [M3], [M4], [M5]) to store the instrument settings.
The R&S NGA100 stores the instruments settings in the selected memory location.

Recall instrument settings

- Press [Store Recall] key to recall instrument settings.
The R&S NGA100 displays a message in the status bar "Recall device settings: select any [Mx] key".

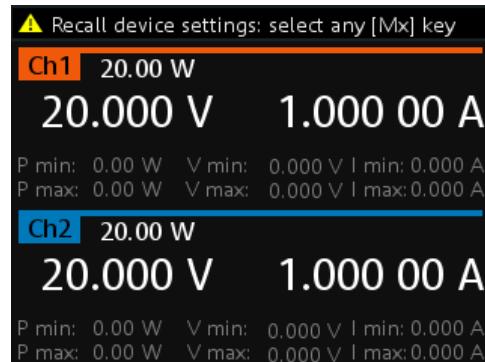

- Press any of the memory keys ([M1],[M2], [M3], [M4], [M5]) to recall the instrument settings.
The R&S NGA100 recalls the instruments settings from the selected memory location.

6.13 Interfaces and Protocols

There are various of ways how the R&S NGA100 can be remotely accessed and controlled.

- Press [Menu] key.
The R&S NGA100 displays the main menu of the instrument.
See [Chapter 5.2.3, "Menu Key"](#), on page 32.
- Select "Interface" menu item to configure the required interface.
The R&S NGA100 displays the available interface options.

6.13.1 Network Connection

There are two methods to establish a local area network (LAN) connection with the R&S NGA100 for remote control operation.

- [LAN](#)
- [Wireless LAN](#)

6.13.1.1 LAN Connection

The R&S NGA100 is equipped with a network interface and can be connected to an Ethernet LAN (local area network). A LAN connection is necessary for remote control of the instrument, and for access from a computer using a web browser.

NOTICE

Risk of network failure

Before connecting the instrument to the network or configuring the network, consult your network administrator. Errors may affect the entire network.



To establish a network connection, connect a commercial RJ-45 cable to the LAN port of the instrument and to a PC or network switch.

Depending on the network capacities, the TCP/IP address information for the instrument can be obtained in different ways.

- If the network supports dynamic TCP/IP configuration using the Dynamic Host Configuration Protocol (DHCP), and a DHCP server is available, all address information can be assigned automatically.
- Otherwise, the address must be set manually. Automatic Private IP Addressing (APIPA) is not supported.

By default, the instrument is configured to use dynamic TCP/IP configuration and obtain all address information automatically. This means that it is safe to establish a physical connection to the LAN without any previous instrument configuration.

NOTICE

Risk of network errors

Connection errors can affect the entire network. If your network does not support DHCP, or if you choose to disable dynamic TCP/IP configuration, you must assign valid address information before connecting the instrument to the LAN. Contact your network administrator to obtain a valid IP address.

1. Connect a LAN cable to the [LAN port](#).
2. Configure the connection settings manually or have the network configure the settings for you via menu. By default, automatic configuration is set in the instrument. For manual configuration, configure the settings as follows:

- a) Select "Ethernet" menu item.
The R&S NGA100 displays the "Ethernet" dialog.

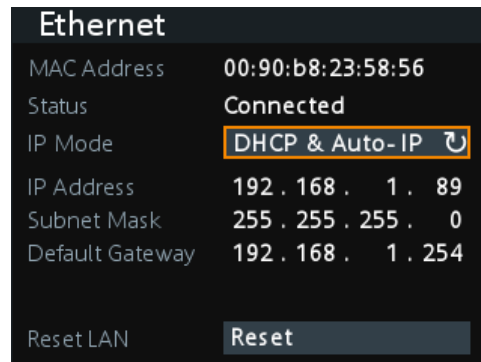

Figure 6-15: Ethernet dialog

- b) Select "DHCP & Auto-IP" for "IP Mode".
c) Enter the "IP Address".
d) Enter the "Subnet Mask".
e) Enter the "Default Gateway".
f) Select "Apply" to complete the configuration.
g) Press [Menu] key to exit the dialog.

Table 6-5: Ethernet input field

Ethernet input field	Description
"MAC Address"	Shows the MAC address of this instrument.
"Status"	Shows if the connection is up or down.
"IP Mode"	"Static & Manual": Manually configure an IP address for the instrument. "DHCP & Auto-IP": Automatically assign an IP address to the instrument.
"IP Address"	Address used in communication with the network. Manually configure this field if IP mode set to "Static & Manual".
"Subnet Mask"	Secondary address used in communication with the network. Manually configure this field if IP mode set to "Static & Manual".
"Default Gateway"	Gateway address to connect to the network. Manually configure this field if IP mode set to "Static & Manual".
"Reset LAN"	Restores the LAN settings to factory default.
"Apply"	Apply static IP settings.

6.13.1.2 Wireless LAN Connection

WARNING

Risk of RF exposure

When WLAN is active, a minimum separation distance of 20 cm from front panel of the instrument must be observed at all times.

When WLAN is active, no operation of antenna or transmitter should be co-located with the instrument.



Wi-Fi transmitter performance

Frequency range: 2412 MHz to 2484 MHz

18.9 dBm (802.11g, 6Mbps)



Instrument option

R&S NGA-K102 (order number: 5601.8419.99) option is required to connect the R&S NGA100 to a network via WLAN connection.



WLAN connection

The LAN connection has a higher priority over WLAN.

If LAN is connected, the WLAN connection will be disconnected. When LAN is disconnected, WLAN will reconnect automatically.

An alternative to connection in local area network is wireless LAN connection. With the presence of an authenticated Wi-Fi signal, the R&S NGA100 automatically connects to a network and navigation can be made via the web browser according to the WLAN IEEE 802.11 b/g/n standards.

1. Select "WLAN" menu item.
The R&S NGA100 displays the "WLAN" dialog.

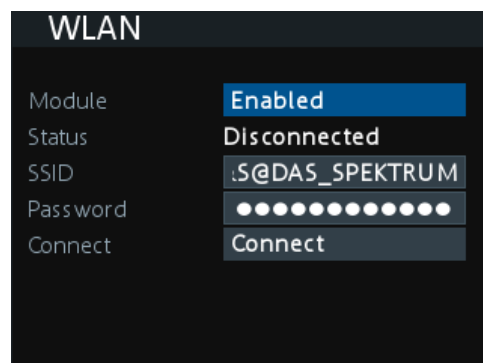

Figure 6-16: WLAN dialog

2. Select "Enabled" for "Module".
3. Set the "SSID"
SSID - Service Set Identifier, a unique ID used for naming wireless network.
4. Set the associated password for the "SSID".
5. Select the "Connect" button.
If connection is successful, the "Status" shows "Connected". See [Figure 6-17](#).
When the connection is alive, the WLAN icon turns green on the status bar. See ["Device status bar"](#) on page 26.

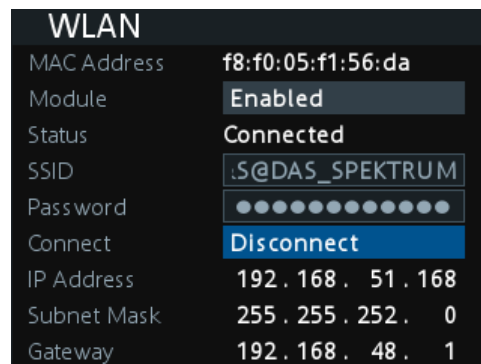

Figure 6-17: WLAN connected

6. To disconnect, select "Disconnect" in the WLAN dialog.

6.13.2 USB Connection



Change of USB class

If a change in "USB Class" is detected (i.e. from "TMC" to "VCP" or vice versa), the rebooting of instrument is necessary to load the correct USB driver.

Alternatively, connect a USB cable to the [USB port](#) and PC for a USB connection. The R&S NGA100 supports USB TMC and USB VCP connection.

1. Select "USB" menu item.
The R&S NGA100 displays the "USB" dialog.

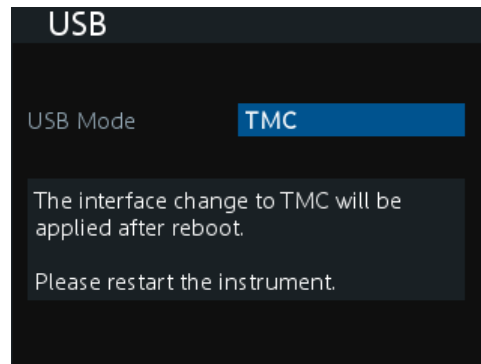

Figure 6-18: USB dialog

2. Set the desired "USB Mode".
 - "VCP": USB virtual COM port
 - "TMC": USB Test & Measurement class
3. Press [Enter] key to confirm the settings.
The R&S NGA100 displays message to prompt the user to restart the instrument to apply the changes.
4. Restart the R&S NGA100 to apply changes.

6.13.2.1 USB VCP



The following requirements for USB-VCP driver installation are necessary:

- A PC with operating system Windows XP, VISTA, Windows 7 or Windows 8 (32Bit or 64Bit).
- Administrator rights are necessary for the installation of the driver.

The USB virtual COM port (USB-VCP) is a software interface that allows the communication to the R&S NGA100 using any terminal program (e.g. HMExplorer) via SCPI commands once the corresponding Windows drivers have been installed. The actual USB-VCP driver and software HMExplorer can be downloaded for free from the product homepage (<http://www.rohde-schwarz.com/product/nga100>).

If a connection between PC and the instrument has been established and no NGA100 USB-VCP driver is installed, the PC operating system displays a "Found New Hardware" wizard. In this case, the NGA100 USB-VCP driver must be installed.

The HMExplorer window application provides the R&S NGA100 a terminal function and also the option to create screenshots and editor function to create the EasyArb table.

For more information of the driver installation and HMExplorer window application, see the installation guide of the driver file and the internal HMExplorer help.

6.13.2.2 USB TMC

The USB Test & Measurement class (USB-TMC) is a protocol that allows GPIB-like communication via USB interfaces and is a separate instrument class of the USB specification. The USB-TMC protocol supports service queries, triggers, and other GPIB-specific instructions.

VISA drivers are installed and that it can be used directly in the corresponding environments. The driver is included in the NI-VISA package and can be downloaded at <http://www.ni.com/downloads/ni-drivers/>.

A major benefit of the USB TMC class is that by sampling specific registers the controlling software can determine if commands have been terminated and if they have been processed correctly. With USB-VCP, communication with instrument requires analysis and polling mechanisms within the controlling software which may significantly strain the interface of the measurement instruments. The TMC status registers solve this problem with the USB TMC in the same manner as in the case with the GPIB interface for the hardware via the corresponding control lines.



HMExplorer

The window application supports the communication via LAN, USB VCP and WLAN only.

For more information of the VISA driver installation, see the installation guide of the VISA driver file.

Once the driver is installed, the "USB Test and Measurement Device (IVI)" is displayed in the Windows "Device Manager" dialog, see [Figure 6-19](#).

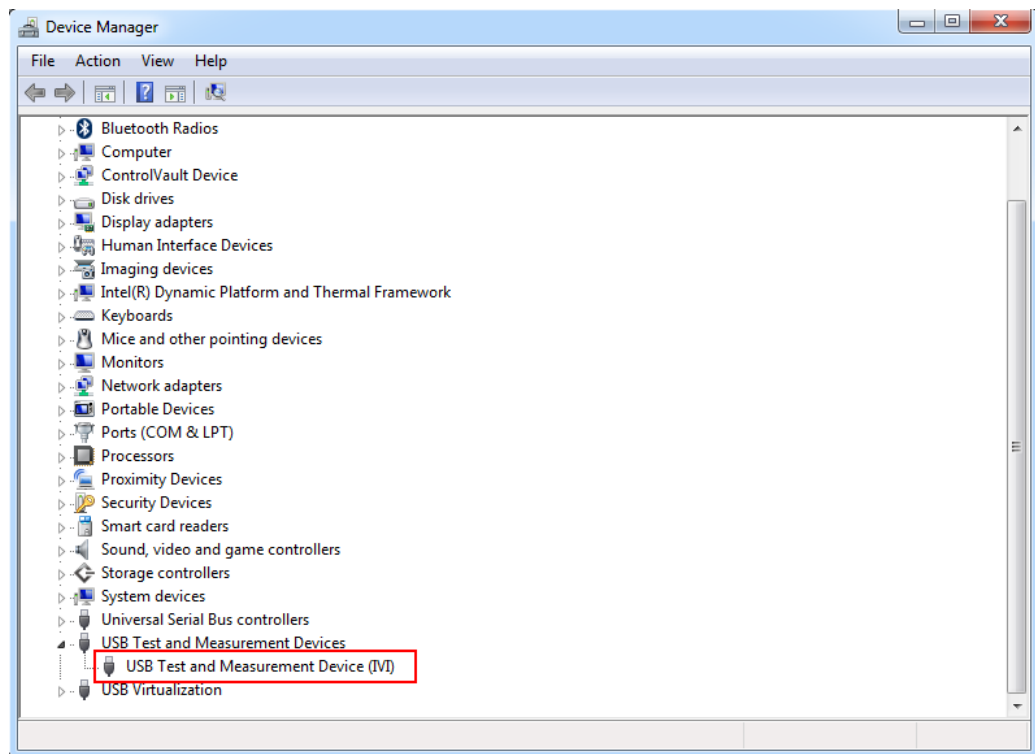

Figure 6-19: Device manager

6.13.3 SCPI

SCPI (Standard Commands for Programmable Instruments) commands - messages - are used for remote control. Commands that are not taken from the SCPI standard follow the SCPI syntax rules. The instrument supports the SCPI version 1999. The SCPI standard is based on standard IEEE 488.2 and aims at the standardization of device-specific commands, error handling and the status registers. The tutorial "Automatic Measurement Control" - A tutorial on SCPI and IEEE 488.2" from John M. Pieper (R&S order number 0002.3536.00) offers detailed information on concepts and definitions of SCPI.

The requirements that the SCPI standard places on command syntax, error handling and configuration of the status registers are explained in detail in the following sections. For more information, see [Chapter 7, "Remote Control Commands"](#), on page 74 and [Chapter A, "Additional Basics on Remote Control"](#), on page 111.

6.13.4 VISA

VISA is a standardized software interface library providing input and output functions to communicate with instruments. The I/O channel (LAN or USB) is selected at initialization time by means of a channel-specific resource string. For more information about VISA, refer to its user documentation.

6.13.5 Setting Up Remote Control Connection

USB

The following shows the resource string format used when setting up a remote connection via the USB interface:

- **USB TMC**
`USB0::0x0AAD::
 0x0197::5601.8002<device_variant>-<device_serial_number>::
 INSTR` where k02 is used for NGA101 device, k03 is used for NGA141 device, k04 is used for NGA102 device, k05 is used for NGA142 device. (e.g. `USB0::0x0AAD::0x0197::5601.8002k05-900211::INSTR`)
- **USB VCP**
`ASRL<COM>::INSTR`, where "COM" refers to the COM port number shown on the controlling PC. (e.g. `ASRL15::INSTR`)

LAN/WLAN

See [Chapter 6.13.1, "Network Connection"](#), on page 57 for configuring the LAN and WLAN parameters.

To set up the connection the IP address of the instrument is required. It is part of the resource string used by the program to identify and control the instrument. The resource string has the form:

```
TCPIP::< IP_address >::INST
```

Example: If the instrument has the IP address 192.1.2.3; the valid resource string is:

```
TCPIP::192.1.2.3::INST
```

High-Speed LAN Instrument Protocol (HiSLIP) is a TCP/IP-based protocol for remote instrument control of LAN-based test and measurement instruments. It was specified by the IVI Foundation and is intended to replace the older VXI-11 protocol. To start remote control session with HiSLIP, the valid resource string is:

```
TCPIP::192.1.2.3::HISLIP
```



The end character must be set to line feed (LF).

Remote

Press [Remote] key to unlock the instrument from the remote control mode. In the remotes mode, all front panel keys on the instrument are disabled and the [Remote] key is illuminated. To switch back to the local mode, press [Remote] key to release the remote control mode.

6.14 General Instrument Settings

The following chapters provide the general instrument information and utilities services in R&S NGA100.

1. Press [Menu] key.
The R&S NGA100 displays the main menu of the instrument.
See [Chapter 5.2.3, "Menu Key"](#), on page 32.
2. Select "Device" menu item to configure the required instrument settings.
3. Select "Utilities" menu item to configure the utilities services.

6.14.1 Instrument Information

The "Information" dialog provides the general instrument information of R&S NGA100.

- ▶ Select "Information" menu item.
The R&S NGA100 displays the "Information" dialog. See [Figure 6-20](#).

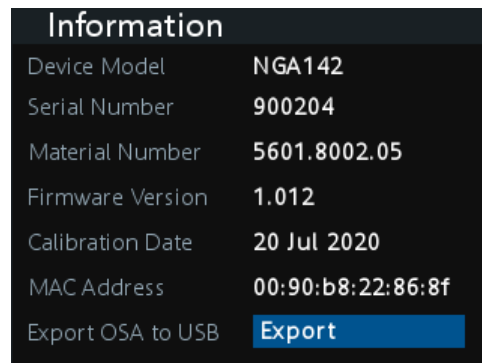

Figure 6-20: Information dialog

Device information	Description
"Device Model"	Model of the instrument, i.e. NGA101, NGA102, NGA141 or NGA 142.
"Serial Number"	Unique identification number for the instrument.
"Material Number"	Instrument orderable part number.
"Firmware Version"	Software version that is installed in the instrument.
"Calibration Date"	The last registered date when calibration was carried out on the instrument.

Device information	Description
"MAC Address"	MAC address of the network interface.
"Export OSA to USB"	The open-source acknowledgment (OSA) of the R&S NGA100 can be exported to USB stick for reference.

6.14.2 General Instrument Settings

General instrument settings such as keypad fallback time, screen display brightness and buzzer setting are provided.

- ▶ Select "General" menu item.
The R&S NGA100 displays the "General" dialog. See [Figure 6-21](#).

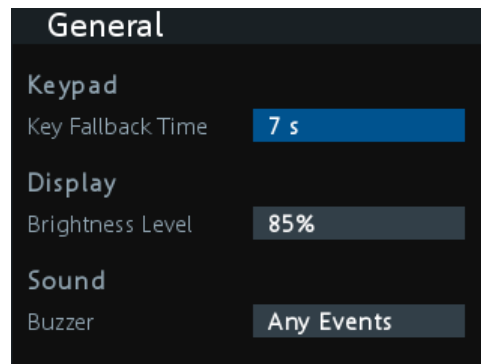

Figure 6-21: General dialog

General instrument settings	Description
Keypad	Selects the wait time before the instrument automatically leaves the editing mode. Select "Off" to disable the automatic switching back.
Display	Selects the specific screen intensity to control the screen brightness. Setting is applied immediately.
Sound	Selects the event where sound is generated. <ul style="list-style-type: none"> • "Fault Events": Sounds on faulty events only • "Any Events": Sounds on faulty events and key press events • Disabled: No sound is generated

6.14.3 Managing Options

Options are enabled by entering a registered license key code.

You may choose to install from an XML file on USB or by manually entering the key code.

- ▶ Select "License" menu item.

The R&S NGA100 displays the "License" dialog. See [Figure 6-22](#).

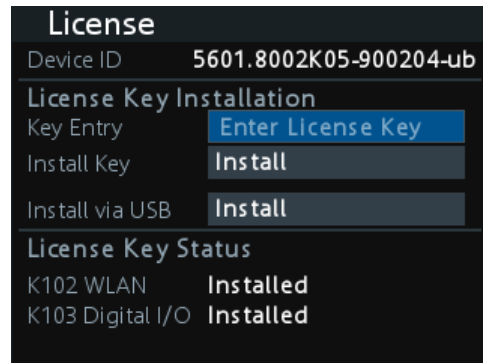

Figure 6-22: License dialog

To install from an XML file, proceed as follows:

1. Copy the XML file containing the registered key code into the USB flash drive.
2. Connect the USB flash drive to the USB port of the instrument.
3. Select "Install".
If the installation is successful, the option is marked as "Installed" under "Installation Status".

To manually enter the key code, proceed as follows:

1. Press [Enter] key to invoke the [On-screen Keyboard](#).
2. Enter the key code (30-digit number) of the option in the entry box.
3. Select "Install".
If the correct key code is entered, the option is marked as "Installed".
If an invalid key code is entered, an error message is displayed. Re-enter the correct key code.

6.14.4 Reset Instrument

This function resets the instrument to factory default settings.

The following settings are reset to default:

- ▶ Select "Reset" menu item.
The R&S NGA100 displays the "Reset" dialog. See [Figure 6-23](#).

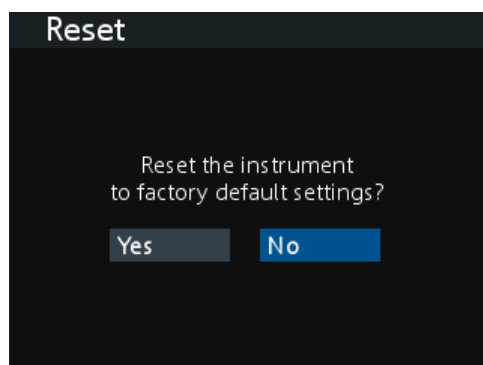

Figure 6-23: Reset dialog

The following parameters are reset to default:

Parameters	Default settings	
	NGA 101, NGA 102	NGA 141, NGA 142
Voltage, current	6.000 V, 6.050	20.00 V, 2.030 A
Overvoltage Protection (OVP) Status, OVP level	Measured, 36.0 V	Measured, 102.0 V
Overpower Protection (OPP) Status, OPP level	Enabled, 41.0 W	Enabled, 41.0 W
Output status	Off	
Channel history information	0	
Channel fusion "Connection Mode"	Off	
"Current Measurement Range"	High	
"Fuse Delay", "Fuse Linking"	0.00 s, Disabled	
"Remote Sense"	Disabled	
"EasyArb Mode on Ch 1"	Disabled	
EasyRamp "Output Ramping", "Ramping Time"	Disabled, 0.01 s	
Digital IO "Master Enabled" "Direction", "Channel", "Condition" "Logic", "Status"	Disabled "Trigger Out", "Ch 1", "Output On" "Active High", "Disabled"	
WLAN SSID, Password	"SSID", "....."	
General "Key Fallback Time", "Brightness Level"	7 s, 85%	

6.14.5 System Test

This function provides a system test to check the instrument working conditions for screen color display, key backlight, beeper and cooling fan.

- ▶ Select "System Test" menu item.
The R&S NGA100 displays the "System Test" dialog. See [Figure 6-24](#).

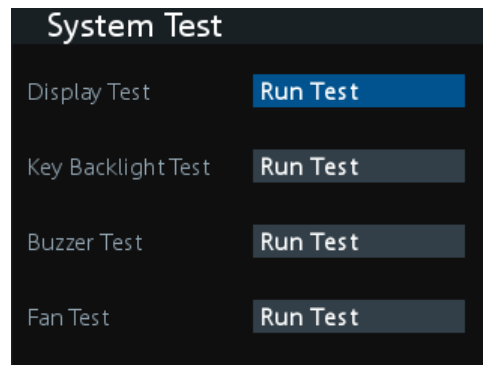

Figure 6-24: System test dialog

System test	Description
"Display Test"	Test that the display is working. RGB and a list of supported colors should appear on the screen during the test.
"Key Backlight Test"	Test that the key backlight is working. During the test, all keys on the front panel illuminate except ([M1], [M2], [M3], [M4], [M5]) and [Store Recall].
"Beeper Test"	Test that the instrument sound is working. Three beep sounds should be heard during the test.
" Fan Test"	Test that the cooling fan is working.

6.14.6 Updating the Firmware

The latest firmware file can be found from the product homepage <http://www.rohde-schwarz.com/product/nga100>.

For firmware update using SCPI command, see "[Firmware update via SCPI command](#)" on page 71.



Do not power off or operate the instrument during a firmware update.
Do not rename the firmware filename.

1. Download the firmware file from the product homepage.
2. Copy the firmware to the root directory of a USB flash drive.

3. Connect the USB flash drive to the USB port of the instrument and wait for ten seconds.
4. Press [Menu] key.
The R&S NGA100 displays the main menu of the instrument. See [Chapter 5.2.3, "Menu Key"](#), on page 32.
5. Select "Utilities" > "Update" menu item.
If firmware file is found, the R&S NGA100 displays the "Update" dialog. See [Figure 6-25](#).

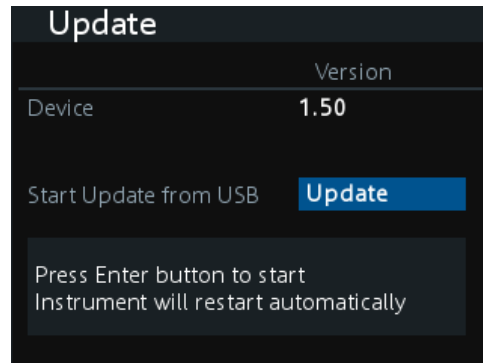

Figure 6-25: Update dialog

6. Press [Enter] key to start firmware update process.
The R&S NGA100 reboots automatically as part of the update process.
7. Alternatively, you can press [Back] key to cancel the firmware update process.
8. Wait for the completion of the update process.
It takes a few minutes to complete the firmware update process.

Firmware update via SCPI command

1. Download the firmware file from the product homepage.
2. Copy the firmware to the root directory of a USB flash drive.
3. Connect the USB flash drive to the USB port of the instrument and wait for ten seconds.
4. Connect to the instrument via [USB](#), [LAN](#) or [WLAN](#).
5. Send `DIAGnostic:SERvice:FWUP "/FRONT_USB/NGA1xx"` to start firmware update remotely.
The R&S NGA100 reboots automatically as part of the update process.
6. Wait for the completion of the update process.
It takes a few minutes to complete the firmware update process.

6.14.7 Help

The "Help" dialog provides the internet link and QR code for the latest R&S NGA100 information.

1. Select "Help" menu item.
The R&S NGA100 displays the "Help" dialog. See [Figure 6-26](#).



Figure 6-26: Help dialog

2. Use a QR code reader to scan the QR code to link to the online product home page.
Alternatively, you could enter the address: <http://www.rohde-schwarz.com/product/nga100> into a browser to access the latest help information.

6.14.8 Date Time

The "Date Time" dialog provides the configuration to set system date and time.

1. Select "Date" menu item.
The R&S NGA100 displays the "Date Time" dialog.

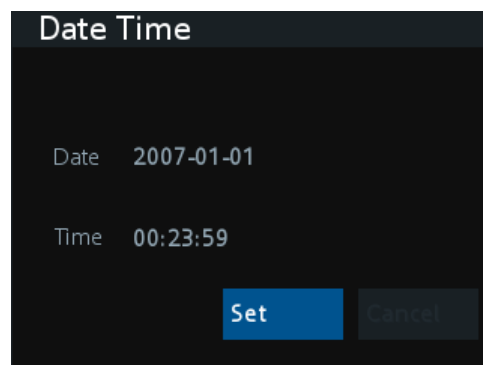
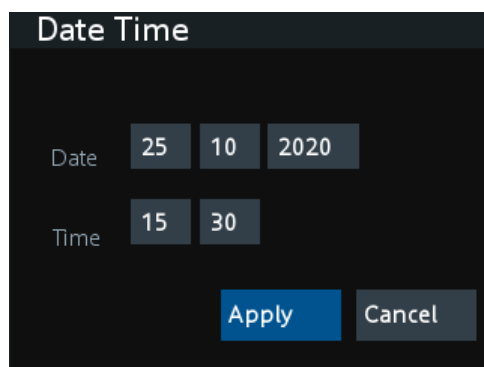

Figure 6-27: Date time dialog

2. Select "Set" to change the system date and time.
The R&S NGA100 displays a dialog to set date and time in "dd mm yyyy" and "hh mm" format respectively.



The image shows a 'Date Time' dialog box with a dark background. It contains two rows of input fields. The first row is labeled 'Date' and has three fields containing '25', '10', and '2020'. The second row is labeled 'Time' and has two fields containing '15' and '30'. At the bottom right, there are two buttons: 'Apply' (highlighted in blue) and 'Cancel' (grey).

3. Set the required date and time accordingly.

7 Remote Control Commands

This chapter provides the description of all remote commands available for the R&S NGA100 series. The commands are sorted according to the menu structure of the instrument. A list of commands in alphabetical order is given in the "List of Command"s at the end of this documentation.

For more information on [Messages and Command Structure](#), see the "Annex" at the end of this documentation.

7.1 Common Commands

The common commands are taken from the IEEE 488.2 (IEC 625-2) standard. A particular command has the same effect on different devices. The headers of these commands consist of an asterisk "*" followed by three letters.

*CLS

Clear status

Sets the status byte (STB), the standard event register (ESR) and the `EVENT` part of the `QUESTIONABLE` and the `OPERATION` registers to zero. The command does not alter the mask and transition parts of the registers. It clears the output buffer.

Usage: Setting only

*ESE <Value>

Event status enable

Sets the event status enable register to the specified value. The query returns the contents of the event status enable register in decimal form.

Parameters:

<Value> Range: 0 to 255

*ESR?

Event status read

Returns the contents of the event status register in decimal form and then sets the register to zero.

Return values:

<Contents> Range: 0 to 255

Usage: Query only

***IDN?**

Identification

Returns the instrument identification.

Return values:

<ID> "Rohde&Schwarz,<device type>,<part number>/serial number,<firmware version>"

Example: Rohde&Schwarz,NGA100,5601.8002k03/100421,1.00

***OPC**

Operation complete

Sets bit 0 in the event status register when all preceding commands have been executed. This bit can be used to initiate a service request. The query writes a "1" into the output buffer when all preceding commands have been executed, which is useful for command synchronization.

***OPT?**

Option identification query

Queries the options included in the instrument. For a list of all available options and their description, refer to the data sheet.

Usage: Query only

***RST**

Reset

Sets the instrument to a defined default status. The default settings are indicated in the description of commands.

Usage: Setting only

***STB?**

Status byte query

Reads the contents of the status byte in decimal form.

Usage: Query only

***WAI**

Wait to continue

Prevents servicing of the subsequent commands until all preceding commands have been executed and all signals have settled (see also command synchronization and *OPC).

Usage: Event

7.2 System Commands

The `SYSTEM` commands perform the various system functions and configure the communication interface (LAN, WLAN) for the instrument.

SYSTEM:BEEPer[:IMMediate]

The instrument returns a single beep immediately.

Usage: Event

SYSTEM:LOCal

This command sets the system to front panel control. The front panel control is unlocked.

Usage: Event

SYSTEM:REMote

This command sets the system to remote state. The front panel control is locked. By pressing **Remote**, the front panel control will be activated.

Usage: Event

SYSTEM:RWLock

This command sets the system to remote state. The front panel control is locked. You are only able to unlock the front panel control via SCPI command `SYSTEM:LOCal` on page 76.

Usage: Event

SYSTEM:OPTion?

This command returns the list of options installed on the instrument.

Return values:

<arg0>

Usage: Query only

SYSTem:TEST:BEEPer

The instrument runs the system test: Beeper Test.

Usage: Event

SYSTem:TEST:FANCtrl

The instrument runs the system test: Fan Control Test.

Usage: Event

SYSTem:TEST:KEYBacklight

The instrument runs the system test: Keypad Backlight Test.

Usage: Event

SYSTem:TEST:SCReen

The instrument runs the system test: Screen Color Test.

Usage: Event

SYSTem:COMMunicate:SOCKet:DHCP[:STATe] <arg0>

This command sets or queries LAN interface mode. ON: automatic IP address from DHCP server; OFF: manually set IP address.

Parameters:

<arg0>

SYSTem:COMMunicate:SOCKet:IPADdress?

This command queries IP address of the LAN interface.

Return values:

<arg0>

Usage: Query only

SYSTem:COMMunicate:WLAN:CONNect

The instrument connects to the predefined wireless access point.

Available only if option R&S NGA-K102 is installed.

Usage: Event

SYSTem:COMMunicate:WLAN:DISConnect

The instrument stops the connection to the predefined wireless access point.

Available only if option R&S NGA-K102 is installed.

Usage: Event

SYSTem:COMMunicate:WLAN:IPADdress?

This command queries the IP address of the device when the wireless interface works as a client.

Available only if option R&S NGA-K102 is installed.

Return values:

<arg0>

Usage: Query only

SYSTem:COMMunicate:WLAN[:STATe] <arg0>

This command activates/deactivates or queries the enable state of the wireless interface.

Available only if option R&S NGA-K102 is installed.

Parameters:

<arg0>

SYSTem:COMMunicate:WLAN:PASSword <arg0>

This command defines the password string of the Access Point when the wireless interface works as a client.

Available only if option R&S NGA-K102 is installed.

Parameters:

<arg0>

Usage: Setting only

SYSTem:COMMunicate:WLAN:SSID <arg0>

This command defines or queries the SSID string of the access point when the wireless interface works as a client.

Available only if option R&S NGA-K102 is installed.

Parameters:

<arg0>

7.3 Configuration Commands

The following subsystems contain the commands for channel selection, voltage and current settings for the instrument.

7.3.1 Channel Selecting

The `INSTRument:Select` subsystem contains the commands for selecting the output channels.

Each channel of the power supply is considered as separate "instrument", which is required by the SCPI standard. Therefore, the SCPI commands use the `INSTRument` node to select a channel.



You can only address the number of channels a device is equipped with, e.g. a maximum of two channels for the NGA102 and NGA142.

Example: Selecting a channel

You can select a channel either with an `OUTput` parameter, or just by the channel number. This example lists all ways how you can select and query a selected channel.

```
// *****
// Select a channel
// *****
// selects channel 1
INST OUT1
// queries the channel selection
INST?
// response: "OUTPut1"
// *****
// Select a channel by its number
// *****
// selects channel number 1
INST:NSEL 1
// queries number of the channel selection
INST:NSEL?
// response: 1
```

INSTRument:NSElect <arg0>

This command defines or queries the numeric selection of a channel. Each channel of the power supply is considered as separate "instrument", which is required by the SCPI standard.

Parameters:

<arg0> {1 | 2}

Example: INSTRument:NSElect 1
 Selects the output channel as Ch 1.
 INSTRument:NSElect? -> 1
 Return the numeric channel selection.

INSTRument[:SElect] <arg0>

This command defines or queries the channel selection. Each channel of the power supply is considered as separate "instrument", which is required by the SCPI standard.

Parameters:

<arg0> OUTPut1 | OUTPut2 | OUTP1 | OUTP2 | OUT1 | OUT2
 OUTPut1 | OUTP1 | OUT1
 Ch 1
 OUTPut2 | OUTP2 | OUT2
 Ch 2

Example: INSTRument OUTPut1
 INSTRument OUTP1
 Selects the output channel as Ch 1.
 INST? -> 2
 Return the output channel as Ch 2.

7.3.2 Remote Sense Setting

The VOLTage:SENSe subsystem contains the command for setting the remote sense for the instrument.

[SOURce:]VOLTage:SENSe <arg0>

Sets or queries the remote sense state of the selected channel.

Parameters:

<arg0> **EXTernal | EXT**
 The internal voltage sense relay in the instrument is switched on and the connection of remote sense wires (S+, S-) to the input of the load become necessary. Failure to connect remote sense can cause over voltage or unregulated voltage output from the R&S NGA100. The voltage sense relay remains switched on even when output is turned off.
 DISable | DIS
 Remote sense is disabled.

Example: VOLT:SENS EXT
 VOLT:SENS? -> EXTernal
 Remote sense state is EXT.

7.3.3 Voltage Setting

The `SOURCE:VOLTage` subsystem contains the commands for setting the voltage of the output channels. The default unit is V.

Example: Configuring the output voltage

This example contains all commands to configure and query the output voltage.

```
// *****
// Select the channel
// *****
INST OUT1
// *****
// Set the voltage value
// *****
// selects a channel and sets the voltage
VOLT 10
// queries the output voltage of a channel
VOLT?
// response: 10.000
// sets the voltage to maximum or minimum respectively
VOLT MAX
VOLT MIN
// *****
// Query the range of the voltage values
// *****
// queries the upper and lower limit of the output voltage
VOLT? MIN
// response: 0.000
VOLT? MAX
// response: 35.05 for NGA101, NGA102 and 100.05 for NGA141, NGA142
```

[SOURCE:VOLTage[:LEVEL][:IMMEDIATE][:AMPLITUDE] <Voltage>

This command defines or queries the voltage value of the selected channel.

Parameters:

<Voltage> {<Voltage> | MINimum | MAXimum | DEFault}

<Voltage>

0.0 V to 35.05 V for NGA101 and NGA102 models (adjustable in 1 mV steps)

0.0 V to 100.05 V for NGA141 and NGA142 models (adjustable in 10 mV steps)

MINimum

0.000E+00

MAXimum

35.05 V for NGA101 and NGA102 models

100.05 V for NGA141 and NGA142 models

Default unit: V

Example: VOLT 10
 Set the voltage value to 10 V.
 VOLT? -> 10
 Return the voltage value of the selected channel.

7.3.4 Current Setting

The `SOURce:CURRent` subsystem contains the commands for setting the current limit of the output channels. The default unit is A.

Example: Configuring the current output

```
// *****
// Select the channel
// *****
INST OUT1
// *****
// Set the current value
// *****
// selects a channel and sets the current
CURR 2
// queries the current of the selected channel
CURR?
// response: 2.000
// *****
// Query the range of the current values
// *****
// queries the upper and lower limit of the current
CURR? MIN
// response: 0.001
CURR? MAX
// response: 6.5 for NGA101 and NGA102 and 2.03 for NGA141 and NGA142
```

[SOURce:]CURRent[:LEVel][:IMMediate][:AMPLitude] <Current>

This command defines or queries the current value of the selected channel.

Parameters:

<Current>	<p><Current> Set current in the range of 1 mA to 6.05 A for NGA101 and NGA102 models or 1 mA to 2.03 A for NGA141 and NGA142 models. Default unit: A</p>
------------------------	---

Example: CURR 2
 Set the selected channel current to 2 A.
 CURR? -> 2
 Return current value of the selected channel .

[SOURce:]CURRent:RANGe <arg0>

Sets or queries the current range of the selected channel.

Parameters:

<arg0>

AUTO | HIGH | LOW

AUTO

The measured output current is displayed in the following:

- "A" with 10 μ A resolution for current above 200 mA
- "mA" with 1 μ A resolution for current below 200 mA

HIGH

The measured output current is displayed in "A" with 10 μ A resolution.

LOW

The measured output current is displayed in "mA" with 1 μ A resolution.

7.3.5 Combined Setting of Voltage and Current Setting

The `APPLY` subsystem provides a command that enables you to set the current and voltage of a channel in one step.

APPLY <arg0>

This command defines or queries the voltage and current value of the selected channel.

Parameters:

<arg0>

{<Voltage> | DEF | MIN | MAX} [, {<Current> | DEF | MIN | MAX}]

<Voltage>

Set voltage in the range of 0 V to 35.05 V for NGA101 and NGA102 models or 100.05 V for NGA141 and NGA142 models.

DEF

Set voltage to default.

MIN

Set voltage to minimum .

MAX

Set voltage to maximum.

<Current>

Set current in the range of 1 mA to 6.05 A for NGA101 and NGA102 models or 1 mA to 2.03 A for NGA141 and NGA142 models.

DEF

Set current to default.

MIN

Set current to minimum.

MAX

Set current to maximum.

Example:

```
INST OUT1
APPLY "6,2"
Set channel 1 to output 6 V and 2 A.
APPLY? -> 6, 2
Return voltage and current value of the selected channel.
```

7.3.6 Output Setting

The `OUTPut` subsystem contains the commands for activating the output channels.

Example: Activating the channels

You can activate a selected channel and turn on or off the outputs either individually or all outputs simultaneously. This example lists all ways how you can activate and query the outputs.

```
// *****
// Activate a channel
// *****
INST OUT1
// activates the selected channel
OUTP:SEL 1
// activates channel 1 and its output
OUTP 1
// queries the output state
OUTP?
// response: 1
// *****
// Turn on all selected channels simultaneously
// *****
// selects channels 1 and 2
// sets the voltage and current values for both channels
// activates both channels
INST:OUT1
VOLT 12
CURR 0.1
OUTP:SEL 1
INST:OUT2
VOLT 12
CURR 0.2
OUTP:SEL 1
// turns on the output of both channels
OUTP:GEN 1
```

OUTPut[:STATe] <arg0>

This command defines or queries for output state for the previous selected channel.

Parameters:

<arg0> {OFF | ON | 0 | 1}

ON | 1

Output state will be turned on.

OFF | 0

Output state will be turned off.

*RST: OFF | 0

Example:

INST OUT1

OUTP ON

Ch 1 and output state will be activated; i.e. **Ch 1** and **Output** key on the front panel will be illuminated.

OUTP? -> 1

Return the output state.

OUTPut:FUSion <arg0>

Sets or queries the output fusion state for 2-channel model.

Parameters:

<arg0>

OFF | SERies | PARAllel

OFF

Output fusion state is off.

SERies

Output fusion state is set to series.

PARAllel

Output fusion state is set to parallel.

Example:

OUTP:FUS SER

OUTP:FUS? -> SER

Output fusion state is set to series.

OUTPut:GENeral <arg0>

This command activates or queries the instrument master output state.

If the master output state is activated, the **Output** key on the front panel will be illuminated.**Parameters:**

<arg0>

{OFF | ON | 0 | 1}

ON | 1

Output state will be activated

OFF | 0

Output state will be deactivated

Example:

```

INST OUT1
OUTP:SEL ON
VOLT 12
CURR 0.1
Ch 1 is activated.

INST OUT2
OUTP:SEL ON
VOLT 12
CURR 0.2
Ch 2 is activated.
OUTP:GEN ON
Ch 1 and Ch 2 and Output state are activated.
OUTP:GEN? -> 1
Return output state of the channel.

```

OUTPut:MODE?

Queries the output operating mode of the previous selected channel

Return values:

```

<arg0>          {OFF | CV | CC}
OFF
Output is turned off.
CV
Output mode changed to constant voltage mode.
CC
Output mode changed to constant current mode.
*RST:          OFF

```

Example:

```

OUTP:MODE? -> CV
Output mode has changed to constant voltage mode.

```

Usage: Query only

OUTPut:SElect <arg0>

This command activates or queries the instrument channel state of the previous selected channel.

If the selected channel is activated, the respective channel key (i.e. **Ch 1**, **Ch 2**) on the front panel will be illuminated.

Parameters:

```

<arg0>          {OFF | ON | 0 | 1}
ON | 1
Selected channel will be activated.
OFF | 0
Selected channel will be deactivated.
*RST:          OFF | 0

```

Example: INST OUT1
OUTP:SEL ON
Ch 1 is activated.

OUTP:SEL? -> 1

Return the state of the selected channel.

OTP:TRIPped?

Queries the overtemperature protection (OTP) tripped state of the previous selected channel.

It is tripped if an OTP event occurs.

Return values:

<arg0> {OFF | ON | 0 | 1}
ON | 1
OTP event occurs.
OFF | 0
OTP event not occurs.
*RST: OFF | 0

Example: OUTP:TRIP? -> 1
OTP event occurs.

Usage: Query only

7.3.7 Fuse Setting

The FUSE subsystem contains the commands for overcurrent protection parameters such as activating fuses and setting fuse parameters of the output channels. The default unit is A.

Example: Configuring fuses

This example contains all commands to configure and query the fuse states and settings.

```
// *****
// Activate a fuse
// *****
INST OUT1
// selects a channel and activates the overcurrent protection
FUSE 1
// queries the state of the overcurrent protection in the selected channel
FUSE?
// response: 1
// *****
// Set a delay time for the overcurrent protection. The delay time
// takes effect when the channel output is turned on.
// *****
// sets 0.05 s delay for the overcurrent protection
FUSE:DEL 0.05
// queries the currently set delay time of the overcurrent protection
// in the selected channel
FUSE:DEL?
// response: 0.05
// sets the delay time to maximum, minimum respectively
FUSE:DEL MAX
FUSE:DEL MIN
// *****
// Query the range of the overcurrent protection delay time
// *****
// queries the upper and lower limit of the
// overcurrent protection delay time in s
FUSE:DEL? MIN
// response: 0
FUSE:DEL? MAX
// response: 10
// *****
// Query a tripped overcurrent protection
// *****
INST OUT1
//queries whether the OCP in channel 1 has tripped
FUSE:TRIP?
//response: 1 OCP is tripped
//response: 0 OCP is not tripped
//resets a tripped OCP in the selected channel
FUSE:TRIP:CLEAr
// *****
// Link the electronic overcurrent protection of the channels logically
// *****
INST OUT1
// links the overcurrent protection of channel 1 with channel 2
```

```

FUSE:LINK 2
// queries the combined overcurrent protection of the selected channel
FUSE:LINK? 2
// response 1
// *****
// Unlink linked overcurrent protection
// *****
FUSE:UNLink 2
// queries the combined overcurrent protection of the selected channel
FUSE:LINK? 2
// response 0

```

FUSE:DELay <Delay>

This command defines and queries the fuse delay for the previous selected channel.

Parameters:

<Delay> {<Delay> | MIN | MAX}

<delay>
0 s to 10 s (adjustable in 0.010 s steps e.g. FUSE:DEL 0.010 = 0.01 s)

MIN
Set fuse delay to minimum.

MAX
Set fuse delay to maximum.

Default unit: ms

Example:

```

INST OUT1
FUSE:DEL 0.050
Set fuse delay of channel 1 to 50 ms.
FUSE:DEL? -> 0.05
Return the fuse delay time of the selected channel.

```

FUSE:LINK <arg0>

This command defines or queries the channel fuses (fuse linking) for the previous selected channel.

Parameters:

<arg0> **1**
channel Ch 1

2
channel Ch 2

Example:

```

INST OUT1
FUSE:LINK 2
Fuse Ch 1 is linked with Ch 2
FUSE:LINK? 2 -> 1
If the fuse of Ch 1 is linked with Ch 2, a "1" is returned.

```

FUSE:TRIPped?

This command queries the fuse tripped of the previous selected channel.

Return values:

<arg0> **ON**
 Fuse is tripped.

OFF
 Fuse is not tripped.

Example: INST OUT1
 FUSE:TRIP? -> 0
 Fuse of Ch 1 has not tripped.

Usage: Query only

FUSE:UNLink <arg0>

This command unlinks the channel fuses (fuse linking) for the previous selected channel.

Parameters:

<arg0> **1**
 channel Ch 1

2
 channel Ch 2

Example: INST OUT1
 FUSE:LINK 2
 FUSE:UNL 2
 Fuse Ch 1 is unlinked with Ch 2

Usage: Setting only

FUSE[:STATe] <arg0>

This command defines or queries the fuse for the previous selected channel.

Parameters:

<arg0> {0 | 1}

1
 Fuse will be activated.

0
 Fuse will be deactivated.

*RST: OFF | 0

Example: INST OUT1
 FUSE ON
 Fuse of Ch 1 is activated
 FUSE? -> 1
 Return fuse state of the selected channel.

7.3.8 OVP Setting

The `VOLTage:PROTection` subsystem contains the commands for setting the over-voltage protection parameters for the output channels. The default unit is V.

Example: Configuring the overvoltage protection

```

// *****
// Set the overvoltage protection value
// *****
INST OUT1
//activates the OVP of the previous selected channel
VOLT:PROT 1
// selects a channel and sets the OVP
VOLT:PROT:LEV 5
// queries the output overvoltage value of a channel
VOLT:PROT:LEV?
// response: 5
// queries the OVP state of the previous selected channel
VOLT:PROT?
// response: 1
// sets the overvoltage protection to maximum,
// or minimum respectively
VOLT:PROT:LEV MAX
VOLT:PROT:LEV MIN
// *****
// Query the range of the overvoltage protection values
// *****
// queries the upper and lower limit
VOLT:PROT:LEV? MIN
// response: 0.100
VOLT:PROT:LEV? MAX
// response: 36.0 for NGA101, NGA102 and 102 for NGA141, NGA142
// *****
// Query a tripped overvoltage protection
// *****
INST OUT1
// queries whether the OVP in channel 1 has tripped
VOLT:PROT:TRIP?
// response: 1 OVP is tripped
// response: 0 OVP is not tripped
// resets a tripped OVP in the selected channel
VOLT:PROT:CLEAr
// *****
// Set the overvoltage protection mode
// *****
INST OUT1
// sets OVP protected mode for channell
VOLT:PROT:MODE PROT
// queres the OVP mode
VOLT:PROT:MODE PROT?
// response: "protected"

```

[SOURce:]VOLTage:PROTection:MODE <arg0>

This command defines or queries the OVP mode for the previous selected channel.

Parameters:

<arg0> MEASured | PROTected

MEASured

The OVP switches off if the measured value exceeds the threshold.

PROTected

If the adjusted threshold is exceeded the output of the instrument will be not switched on; additionally the measured value is monitored (please also refer to function MEASured).

Example:

```
INST OUT1
VOLT:PROT:MODE PROT
Sets OVP protected mode for Ch 1.
VOLT:PROT:MODE? -> PROTected
Return the selected channel OVP mode.
```

[SOURce:]VOLTage:PROTection:TRIPped?

This command queries the OVP tripped status of the previous selected channel.

Return values:

<arg0> ON | OFF
ON
OVP is tripped
OFF
OVP is not tripped

Example:

```
INST OUT1
VOLT:PROT:TRIP? -> OFF
OVP of Ch 1 has not tripped.
```

Usage:

Query only

[SOURce:]VOLTage:PROTection[:STATe] <arg0>

This command defines or queries the OVP state for the previous selected channel.

Parameters:

<arg0> 1 | 0
1
OVP is activated.
0
OVP is deactivated.

Example: INST OUT1
 VOLT:PROT ON
 OVP of Ch 1 is activated.
 VOLT:PROT? -> 1
 Return the OVP state of the selected channel.

[SOURce:]VOLTage:PROTection:LEVel <Voltage>

This command defines or queries the OVP value of the previous selected channel.

Parameters:

<Voltage> {<Voltage> | MIN | MAX}

<Voltage>

Set the OVP value in the range of 0 mV up to 36 V for NGA101 and NGA102 models or 0 mV up to 102 V for NGA141 and NGA142 models (adjustable in 100 mV steps):

MIN

Set the OVP value to minimum.

MAX

Set the OVP value to maximum.

Default unit: V

Example: INST OUT1
 VOLT:PROT:LEV 5
 Set the OVP value of Ch 1 to 5 V.
 VOLT:PROT:LEV?
 Return the selected channel OVP value.

[SOURce:]VOLTage:PROTection:CLEar

This command resets the OVP state of the selected channel. If the OVP has tripped the OVP message on the display will be cleared for the selected channel.

Usage: Event

7.3.9 OPP Setting

The POWer:PROTection subsystem contains the commands for setting the over-power protection parameters for the output channels. The default unit is W.

Example: Configuring the overpower protection

```
// *****
// Set the overpower protection value
// *****
INST OUT1
//activates the OPP of the previous selected channel
POW:PROT 1
// selects a channel and sets the OPP
POW:PROT:LEV 5
// queries the output overvoltage value of a channel
POW:PROT:LEV?
// response: 5
// queries the OPP state of the previous selected channel
POW:PROT?
// response: 1
// sets the overvoltage protection to maximum,
// or minimum respectively
POW:PROT:LEV MAX
POW:PROT:LEV MIN
// *****
// Query the range of the overpower protection values
// *****
// queries the upper and lower limit
POW:PROT:LEV? MIN
// reponse: 0.0
POW:PROT:LEV? MAX
// reponse: 41.0
// *****
// Query a tripped overpower protection
// *****
INST OUT1
// queries whether the OPP in channel 1 has tripped
POW:PROT:TRIP?
// response: 1 OPP is tripped
// response: 0 OPP is not tripped
// resets a tripped OPP in the selected channel
POW:PROT:CLEAr
```

[SOURCE:]POWER:PROTECTION:LEVEL <Power>

This command defines or queries the OPP value of the previous selected channel.

Parameters:

<Power>

{<Voltage> | MIN | MAX}

<Voltage>

Set the OPP value in the range of 0 W up to 41W (adjustable in 100 mW steps)

MIN

Set the OPP value to minimum.

MAX

Set the OPP value to maximum

Default unit: W

Example:

INST OUT1

POW:PROT:LEV 5

Set the OPP value of channel 1 to 5 W.

POW:PROT:LEV? -> 5

Return the selected channel OPP value.

[SOURce:]POWER:PROTECTION:TRIPped?

This command queries the OPP tripped status of the previous selected channel

Return values:

<arg0> 1 | 0

1

OPP is tripped.

0

OPP is not tripped.

Example:

INST OUT1

POW:PROT:TRIP? -> 0

OPP state of Ch 1 has not tripped.

Usage:

Query only

[SOURce:]POWER:PROTECTION[:STATE] <arg0>

This command defines or queries the OPP state for the previous selected channel.

Parameters:

<arg0> ON | OFF | 1 | 0

ON | 1

OPP is activated.

OFF | 0

OPP is deactivated.

Example:

INST OUT1

POW:PROT ON

OPP of Ch 1 is activated.

POW:PROT?

Return the OPP state of the selected channel.

[SOURce:]POWER:PROTECTION:CLEAR

This command resets the OPP state of the selected channel. If the OPP has tripped the red blinking OPP message on the display will be cleared for the selected channel.

Usage:

Event

7.4 Measurement Commands

The MEASure subsystem provides commands to query the voltage and current values of a channel.

MEASure[:SCALar]:CURRent[:DC]?

This command queries the measured current value of the previous selected channel.

Return values:

<Current> <numeric_value>
Return the measured current.
Default unit: A

Example: MEAS:CURR? -> 1.000

Usage: Query only

MEASure[:SCALar]:POWer?

This command queries the measured power value of the previous selected channel.

Return values:

<Power> <Numeric_value>
Return the measured power value.
Default unit: W

Example: MEAS:POW? -> 3.00E+00
Return the measured power value of the selected channel.

Usage: Query only

MEASure[:SCALar][:VOLTage][:DC]?

This command queries the measured voltage value of the previous selected channel.

Return values:

<Voltage> <numeric_value>
Return the measured voltage.
Default unit: V

Example: MEAS? -> 1.000E+00

Usage: Query only

7.5 Advanced Operating Commands

The following shows the subsystem that contains the commands for configuring the arbitrary function, easyramp and Digital I/O functions.

7.5.1 Arbitrary Commands

The `ARbitrary` subsystem contains the commands for configuring an arbitrary sequence for the output channels.

Example: Configuring an arbitrary sequence

This programming example generates an arbitrary sequence for a selected channel. The sequence starts at 1 V and 1 A for 1 sec, and both values are incremented each second by 1. The generated arbitrary waveform is transferred to Ch 1. When activated, the R&S NGA100 provides the arbitrary waveform at the output of the selected channel, and repeats it 10 times.

ARbitrary:CLEar

This command clears the previous defined arbitrary waveform data for channel 1.

Usage: Event

ARbitrary:DATA <arg0>

Defines or queries the arbitrary points for channel 1. The dwell time between two points is from 10ms to 600s.

Parameters:

<arg0> <Voltage1, Current1, Time1, Voltage2, Current2, Time2,..., Voltage128, Current128, Time128>

Voltage1 ... Voltage128

Defines the arbitrary points of the voltage.

Current1 ... Current128

Defines the arbitrary points of the current.

Time1 ... Time128

Defines the arbitrary points of the time (The unit for time is ms).

Example: `ARB:DATA "10.5,3,10,20,2,1000,15,2.1,10000"`

ARbitrary:RCL <arg0>

This command recalls EasyArb settings and previous defined arbitrary points from the respective memory locations M1-M5.

Parameters:

<arg0> Range: 0..4

Usage: Setting only

ARbitrary:REPetitions <Repetitions>

This command defines or queries the repetition of the defined arbitrary waveform for channel 1.

Note: If the repetition is set to "0", the arbitrary waveform repeats continuously.

Parameters:

<Repetitions> 0..255

Example:

ARB:REP 10

Set the repetition rate of the defined arbitrary waveform as 10.

ARB:REP? -> 10

Return the defined repetition rate of the selected channel.

ARbitrary:POINTs?

This command returns the number of arbitrary points of EasyArb waveform.

Return values:

<arg0>

Usage: Query only

ARbitrary[:STATe] <arg0>

This command activates/deactivates or queries the EasyArb state. ON: Ch 1 is ready to run arb waveform.

Parameters:

<arg0> {OFF | ON}

ON

EasyArb state is activated.

OFF

EasyArb state is deactivated.

ARbitrary:SAV <arg0>

This command saves EasyArb settings and previous defined arbitrary points into the respective memory locations M1-M5.

Parameters:

<arg0> Range: 0..4

Example:

INST 1

ARB:DATA 10,1,0,5,0

ARB:REP 10

ARB:SAV 1

Usage: Setting only

ARbitrary:START

This command starts the previous transferred EasyArb waveform in channel 1 if Easy-Arb is enabled.

Usage: Event

ARbitrary:STOP

This command stops the EasyArb waveform in channel 1 if EasyArb is running.

Usage: Event

7.5.2 EasyRamp Commands

The `VOLTage:RAMP` subsystem contains the commands for configuring the ramp function for the output channels.

[SOURce:]VOLTage:RAMP:DURation <Time>

This command sets/queries the EasyRamp duration of the previous selected channel in seconds. 0.01 s to 10 s in steps of 0.01 s.

Parameters:

<Time> Range: 0.010 to 10
 *RST: 0.010
 Default unit: ms

[SOURce:]VOLTage:RAMP[:STATe] <arg0>

This command defines/queries the EasyRamp state for the previous selected channel.

Parameters:

<arg0> {OFF | ON}
ON
 EasyRamp function is activated.
OFF
 EasyRamp function is disabled.

7.5.3 DIO Commands

The `DIO` subsystem contains the commands for configuring a Digital I/O function for the output channels.

TRIGger:DIRection:DIO<IO> <arg0>

This command sets or queries the specified Digital I/O line to function as Trigger Input or Trigger Output.

Suffix:

<IO> 1..4

Parameters:

<arg0> OUTPut | INPut

Example: TRIG:DIR:DIO2 OUT

TRIGger[:ENABLE]:DIO<IO> <arg0>

This command sets or queries the state of the specified Digital I/O line.

The state is disabled when any setting has been changed.

Suffix:

<IO> 1..4

Parameters:

<arg0> {OFF | ON}

ON

Enable the state for Digital I/O line.

OFF

Disable the state for Digital I/O line.

*RST: OFF

TRIGger:IN:ARBitrary:DIO<IO> <arg0>

This command sets or queries the operation mode when starting EasyArb by Trig IN.

Suffix:

<IO> 1..4

Parameters:

<arg0> PULSe | LEVeL

PULSe

Starts EasyArb when trigger signal activated.

LEVeL

Starts EasyArb when trigger signal activated and stops when trigger signal de-activated.

*RST: PULSe

Example:

TRIG:IN:ARB:DIO1 PULS

TRIGger:IN:RESPonse:DIO<IO> <arg0>

This command sets or queries the output response of the trigger input of the specified Digital I/O line.

Suffix:

<IO> 1..4

Parameters:

<arg0> ON | OFF | TOGGle | INHibit | ARBitrary

ON

Output is switched on.

OFF

Output is switched off.

TOGGle

Output state is toggled.

INHibit

Output state remains off as long as the TRIG IN signal is activated.

ARBitrary

Starts the EasyArb function. If level signal is selected, the Easy-Arb function is stopped when TRIG IN signal is deactivated.

*RST: OFF

TRIGger:IN:SOURce:DIO<IO> <arg0>

This command sets or queries the source under control of the trigger input of the specified Digital I/O line.

Suffix:

<IO> 1..4

Parameters:

<arg0> **CH1**
Trigger input source from Ch 1.

CH2
Trigger input source from Ch 2.

*RST: CH1

TRIGger:LOGic:DIO<IO> <arg0>

This command sets or queries the trigger logic (Active High/Active Low) of the specified Digital I/O line.

Suffix:

<IO> 1..4

Parameters:

<arg0> LOW | HIGH

*RST: HIGH

TRIGger:MASTer[:STATe] <arg0>

This command defines or queries the master enable state for the Digital I/O interface. The state is disabled when any setting has been changed.

Parameters:

<arg0> {OFF | ON}

ON

"Master Enable" state is activated for all DIO interfaces.

OFF

"Master Enable" state is deactivated for all DIO interfaces.

*RST: OFF

TRIGger:OUT:CONDition:DIO<IO> <arg0>

This command sets the trigger condition of the trigger output of the specified Digital I/O line.

The line triggers when the output of the specified control source is turned off or on

Suffix:

<IO> 1..4

Parameters:

<arg0> ON | OFF | FUSetrip | CCMode | VOLTlevel | CURRlevel | CRITevent | ARBitrary

ON

Trigger output is turned on.

OFF

Trigger output is turned off.

FUSetrip

Trigger output is linked to fuse tripped event.

VOLTlevel

Trigger output is linked to a set voltage level event.

CURRlevel

Trigger output is linked to a set current level event.

CRITevent

Trigger output is linked to a critical triggered event.

ARBitrary

Trigger output is linked to a EasyArb event.

*RST: ON

TRIGger:OUT:CRITevent:DIO<IO> <arg0>

This command sets or queries the critical event of the trigger output of the specified Digital I/O line.

Suffix:

<IO> 1..4

Parameters:

<arg0> OVP | OPP | OTP

OVP

Trigger output is linked to the OVP event

OPP

Trigger output is linked to the OPP event

OTP

Trigger output is linked to the OTP event

*RST: OVP

TRIGger:OUT:CURRlevel:DIO<IO> <Current>

This command sets or queries the threshold current level of the trigger output of the specified Digital I/O line.

Triggers when output current level exceeds or equals to the set level.

Suffix:

<IO> 1..4

Parameters:

<Current> *RST: 3.000
Default unit: A

TRIGger:OUT:SOURce:DIO<IO> <arg0>

This command sets or queries the control source of the trigger output of the specified Digital I/O line.

Suffix:

<IO> 1..4

Parameters:

<arg0> **CH1**
Trigger output source from Ch 1.
CH2
Trigger output source from Ch 2.
*RST: CH1

TRIGger:OUT:VOLTlevel:DIO<IO> <Voltage>

This command sets or queries the threshold voltage level of the trigger output of the specified Digital I/O line.

Triggers when output voltage level exceeds or equals to the set level.

Suffix:

<IO> 1..4

Parameters:

<Voltage> *RST: 0.0
Default unit: V

TRIGger:RCL <arg0>

This command recalls DIO settings from the respective memory locations M1-M5.

Parameters:

<arg0> Range: 0..4

Example: TRIG:RCL 1

Usage: Setting only

TRIGger:SAV <arg0>

This command saves DIO settings into the respective memory locations M1-M5

Parameters:

<arg0> Range: 0..4

Example: TRIG:SAV 1

Usage: Setting only

7.6 Data and File Management Commands

The `DATA` and `HCOPY` subsystem contains commands for managing the files in the instrument and external USB stick.

The `LOG` subsystem contains the commands for managing the data logging of the instrument.

HCOPY:DATA?

This command queries current screen content. BMP format is supported.

Return values:

<arg0>

Usage: Query only

HCOPY:SIZE:X?

This command returns the horizontal expansion of the screenshots.

Return values:

<arg0>

Usage: Query only

HCOPY:SIZE:Y?

This command returns the vertical expansion of the screenshots.

Return values:

<arg0>

Usage: Query only

LOG[:STATe] <arg0>

Sets or queries the data logging state.

Parameters:

<state>

ON | 1

Data logging function is enabled.

OFF | 0

Data logging function is disabled.

***RST:** 0**Example:**

LOG ON

LOG? -> 1

Data logging function is activated.

DATA:DATA? <>**DATA:DATA?? <>**

Returns the logging file data of the selected file.

Parameters:

<filepath> Filepath of the logging file data.

Example:

DATA:DATA?

"/tmp/usbhd-sdb1/log-20210101T101632.csv" ->

#Device,NGA142

#Device Name,rs-instrument.local

#Format,LOG

#Date,2021-1-1

#Version,2.001 009F41098

#Logging Interval[s],0.1 Time-

stamp,U1[V],I1[A],P1[W],U2[V],I2[A],P2[W]

10:16:33.370,16.855,0.00010,0.00,12.028,0.00026,0.00,

10:16:33.484,16.855,0.00010,0.00,12.028,0.00026,0.00, "

Usage:

Query only

DATA:LIST?

Queries all files in internal memory ('/int') and external memory ('/USB').

Example:

DATA:LIST? ->

"log-20210101T101557.csv,log-20210101T101632.csv,log-20210101T110506.csv,"

Usage:

Query only

7.7 Firmware Update

The following shows the subsystem that contains the commands for firmware update function.

DIAGnostic:SERVice:FWUP <arg0>

Starts instrument firmware update remotely.

For more information, see [Chapter 6.14.6, "Updating the Firmware"](#), on page 70.

Parameters:

<arg0>

Example:

DIAGnostic:SERvice:FWUP "/FRONT_USB/NGA1xx"

Usage:

Setting only

8 Applications

8.1 Parallel and Series Mode

⚠ WARNING

It is assumed that only qualified and trained personnel service the power supplies and the connected loads.

NOTICE

Use only the R&S NGA100 power supply series when operating the channels in a series or parallel mode to increase the output voltage and current.

⚠ DANGER**Series connection**

A series connection may cause dangerous voltages.

To increase output voltage and currents, it is possible to operate the channels in series or parallel mode. In general, the output voltages of R&S NGA100 to be combined are independent.

8.1.1 Series Mode

This type of interconnection adds the individual output voltages. The same current flows through all outputs. The current limits for the outputs wired in series should be set to the identical value. If one of the outputs exceeded the current limit, the total voltage will naturally collapse. See [Chapter 5.5, "Operation Modes"](#), on page 36.

It is advisable to set the voltages of all connected channels voltages to a similar value to distribute the loads evenly (not absolutely necessary). When both channels are connected in a series mode and if a (low resistance) load is connected; there is a chance of damaging a channel when that channel is switch off. This is due to the protection diode working as a bypass to connect the other channel in a series mode. Once the protection diode is shorted, the channel will be defective.

Therefore, it is necessary to always have all channels or no channel at all switched on.



If the instrument switches to constant current output mode (CC) during a series connection, the voltage display becomes inaccurate.

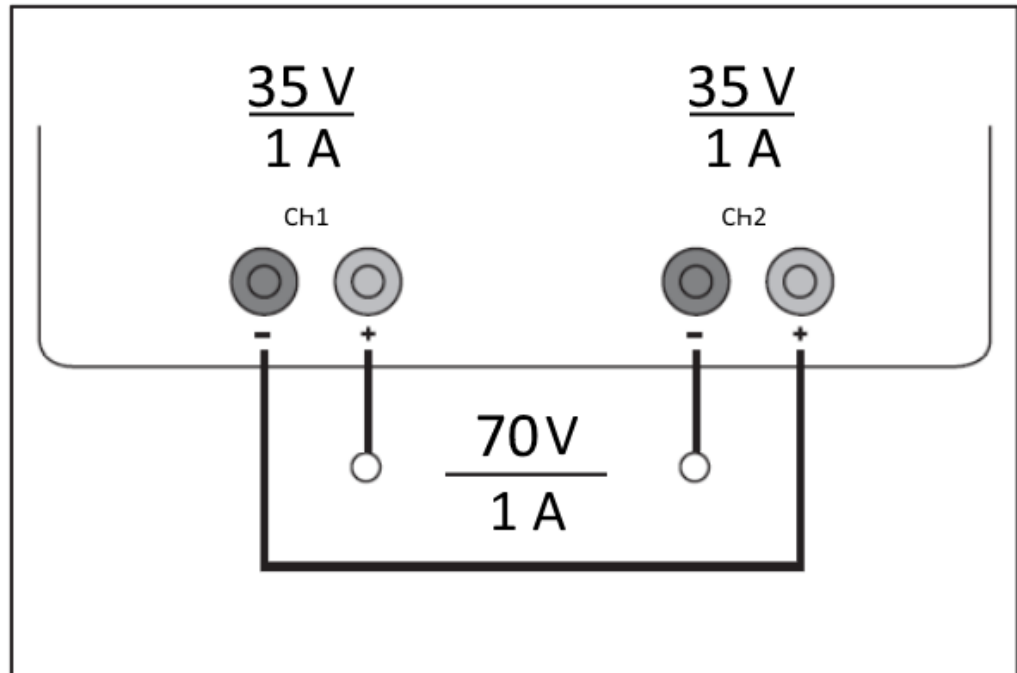

Figure 8-1: Example of series connection

8.1.2 Parallel Mode

If it is necessary to increase the total current, the power supply outputs must be wired in parallel. The maximum total current is the sum of the individual currents of all sources connected in parallel. The output voltages for the individual outputs should be set to the same voltage value as precisely as possible. For slight voltage differences, it is common in this operating mode to first charge a voltage output up to the current limit; the other voltage output provides the remaining current. See "[Principles of operation in parallel mode](#)" on page 110.

For power supplies that are connected in parallel, it is possible that compensating currents flow within the power supplies. The use of power supplies by other manufacturers, which are potentially not overload proof, can cause destruction of these units as currents may be distributed unevenly.

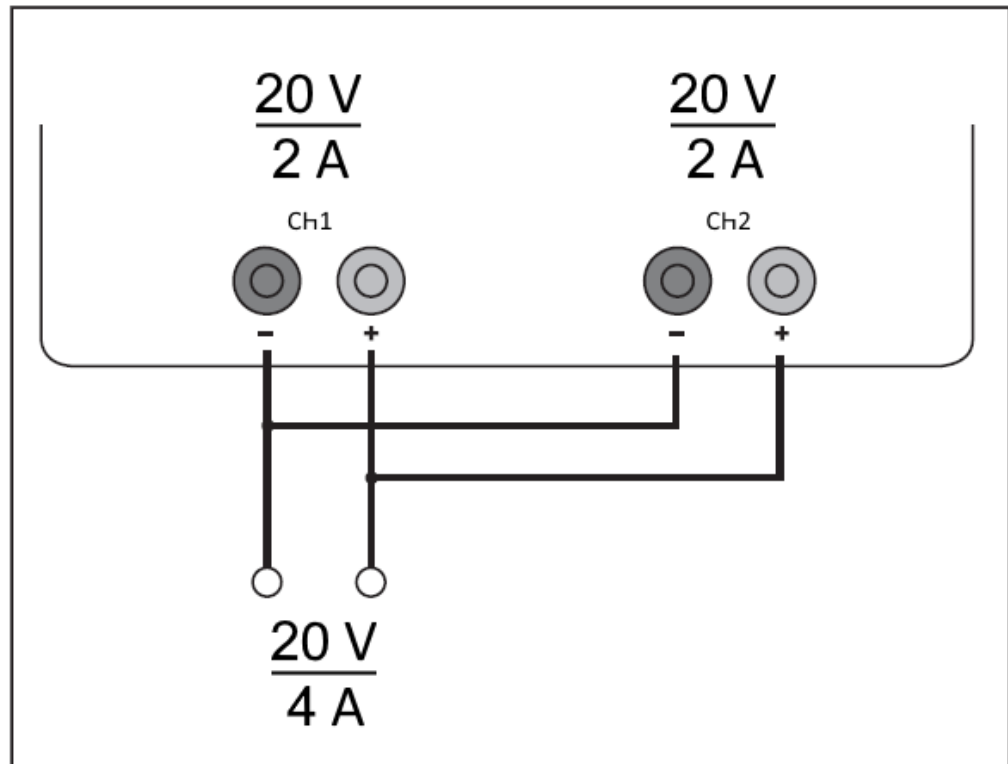

Figure 8-2: Example of parallel connection

Principles of operation in parallel mode

Generally, a higher current will first be supplied from the channel with the higher output voltage. Once this channel reaches its power limit, the remaining current will be made available by the channel that is connected in parallel. In this scenario, it is unpredictable which channel will supply the higher current because it is also possible for channels with identical voltage values to display a low voltage difference.

By increasing the voltage slightly, the load distribution can be manipulated. If the voltage for a channel is to be increased by 50mV, for instance (by a set of identical cables), the current will initially be provided by this channel.

If you wish to distribute the load to multiple channels, it is recommended to set the current limit of the channel that is to supply the main current to a fraction of the current. This approach handles the semiconductor with care and improves the heat dissipation, as the power loss is distributed more evenly.

Annex

A Additional Basics on Remote Control

A.1 Messages and Command Structure

A.1.1 Messages

Instrument messages are employed in the same way for all interfaces, if not indicated otherwise in the description.

- Structure and syntax of the instrument messages: [Chapter A.1.2, "SCPI Command Structure"](#), on page 112
- Detailed description of all messages: [Chapter 7, "Remote Control Commands"](#), on page 74

There are different types of instrument messages:

- Commands
- Instrument responses

Commands

Commands (program messages) are messages which the controller sends to the instrument. They operate the instrument functions and request information. The commands are subdivided according to two criteria:

Effects on the instrument:

- Setting commands cause instrument settings such as a reset of the instrument or setting the output voltage.
- Queries return data for remote control, e.g. for identification of the instrument or polling a parameter value. Queries are formed by appending a question mark to the command header.

Applied standards:

- The function and syntax of the common commands are precisely defined in standard IEEE 488.2. If implemented, they are used identically on all instruments. They refer to functions such as management of the standardized status registers, reset and self-test.
- Instrument control commands refer to functions depending on the features of the instrument such as voltage settings. Many of these commands have also been standardized by the SCPI committee. These commands are marked as "SCPI compliant" in the command reference chapters. Commands without this SCPI label

are device-specific, however, their syntax follows SCPI rules as permitted by the standard.

Instrument responses

Instrument responses (response messages and service requests) are messages which the instrument sends to the controller after a query. They can contain measurement results, instrument settings and information on the instrument status.

A.1.2 SCPI Command Structure

SCPI commands consist of a so-called header and, usually, one or more parameters. The header and the parameters are separated by a whitespace. The headers can consist of several mnemonics (keywords). Queries are formed by appending a question mark directly to the header. The commands can be either device-specific or device-independent (common commands). Common and device-specific commands differ in their syntax.

Syntax for Common Commands

Common (= device-independent) commands consist of a header preceded by an asterisk (*) and possibly one or more parameters.

Table A-1: Examples of Common Commands

Command	Command Name	Description
*RST	Reset	Resets the instrument.
*ESE	Event Status Enable	Sets the bits of the event status enable registers.
*ESR?	Event Status Query	Queries the content of the event status register.
*IDN?	Identification Query	Queries the instrument identification string.

Syntax for Device-Specific Commands

For demonstration purposes only, assume the existence of the following commands for this section:

- MEASure:CURRent[:DC]?
- MEASure:VOLTage[:DC]?
- FUSE[:STATe] {0 | 1}
- FUSE[:STATe]?

Long and short form

The mnemonics feature a long form and a short form. The short form is marked by uppercase letters, the long form corresponds to the complete word. You can enter either the short form or the long form; other abbreviations are not permitted.

Example:

MEASure:CURRent? is equivalent to MEAS :CURR?

**Case-insensitivity**

Uppercase and lowercase notation only serves to distinguish the two forms in the manual, the instrument itself is case-insensitive.

Optional mnemonics

Some command systems permit inserting or omitting certain mnemonics in the header. These mnemonics are marked by square brackets. The instrument must recognize the long command to comply with the SCPI standard. Some commands are shortened by these optional mnemonics.

Example:

FUSE[:STATe] { ON }

FUSE:STAT ON is equivalent to FUSE ON

Special characters

Table A-2: Special characters

	A vertical stroke in parameter definitions indicates alternative possibilities in the sense of "or". The effect of the command differs, depending on the used parameter. Example: <ul style="list-style-type: none"> • FUSE:LINK {1 2 3} • FUSE:LINK 1 sets the fuse link CH 1 for the selected channel FUSE:LINK 2 sets the fuse link of CH 2 for the selected channel
[]	Mnemonics in square brackets are optional and can be inserted into the header or be omitted. Example: <ul style="list-style-type: none"> • FUSE[:STATe] { ON } • FUSE:STAT ON is equivalent to FUSE ON
{ }	Parameters in curly brackets are optional and can be inserted once or several times, or be omitted. Example: <ul style="list-style-type: none"> • VOLTage[:LEVel][:IMMediate][:AMPLitude] {<voltage> MIN MAX UP DOWN } <p>The following are valid commands:</p> <ul style="list-style-type: none"> – VOLT MAX – VOLT MIN – VOLT 10

SCPI Parameters

Many commands are supplemented by a parameter or a list of parameters. The parameters must be separated from the header by a whitespace (ASCII code 0 to 9, 11 to 32 decimal, e.g. blank).

Allowed parameters are:

- Numeric values
- Special numeric values
- Boolean parameters
- Text

- Character strings
- Block data

The required parameters and the allowed value range are specified in the command description.

Numeric values

You can enter numeric values in the following form. Values exceeding the resolution of the instrument are rounded up or down.

Example:

```
VOLT 10V = VOLT 10
```

```
VOLT 100mV = VOLT 0.1
```

Special numeric values

The text listed below are interpreted as special numeric values. In the case of a query, the numeric value is provided.

- MIN / MAX
- MINimum and MAXimum denote the minimum and maximum value.

Example:

```
VOLT:PROT? MAX
```

Returns the maximum numeric value.

Boolean parameters

Boolean parameters represent two states:

- **On** (logically true), is represented by "On" or the numeric value "1"
- **Off** (logically false), is represented by "Off" or the numeric value "0"

The instrument returns the numerical value when queried.

Example:

```
OUTP:STAT ON
```

```
OUTP:STAT?
```

Response: 1

Overview of Syntax Elements

The following table provides an overview of the syntax elements:

Table A-3: Syntax Elements

:	A colon separates the mnemonics of a command.
,	A comma separates several parameters of a command.
?	A question mark forms a query.
*	An asterisk marks a common command.

"	Quotation marks introduce a string and terminate it.
	A whitespace (ASCII-Code 0 to 9, 11 to 32 decimal, e.g. blank) separates the header from the parameters.

Responses to Queries

You can query each setting command by adding a question mark. According to SCPI, the responses to queries are partly subject to stricter rules than in the standard IEEE 488.2.

- The requested parameter is transmitted without a header.
VOLTage:PROTection:MODE?
Response: "MEASure"
- Maximum values, minimum values and all other quantities that are requested via a special text parameter are returned as numeric values.
VOLT:PROT? MAX
Response: 32.500
- Boolean values are returned as 0 (for Off) and 1 (for On).
OUTPut:STATe?
Response: 1

A.2 Command Sequence and Synchronization

A sequential command finishes the execution before the next command is starting. To make sure that commands are actually carried out in a certain order, each command must be sent in a separate command line.



As a rule, send commands and queries in different program messages.

A.2.1 Preventing Overlapping Execution

Table A-4: Synchronization using *OPC, *OPC? and *WAI

Command	Action	Programming the controller
*OPC	Sets the Operation Complete bit in the ESR after all previous commands have been executed.	<ul style="list-style-type: none"> Setting bit 0 in the ESE Setting bit 5 in the SRE Waiting for service request (SRQ)
*OPC?	Stops command processing until 1 is returned. It occurs after the Operation Complete bit has been set in the ESR. This bit indicates that the previous setting has been completed.	Sending *OPC? directly after the command whose processing should be terminated before other commands can be executed.
*WAI	Stops further command processing until all commands have been executed before *WAI.	Sending *WAI directly after the command whose processing should be terminated before other commands are executed

To prevent an overlapping execution of commands the commands *OPC, *OPC? or *WAI can be used. All three commands cause a certain action only to be carried out after the hardware has been set. The controller can be forced to wait for the corresponding action.



The R&S NGA100 series does not support parallel processing of remote commands. If OPC? returns a "1", the device is able to process new commands.

List of commands

[SOURce:]CURRent:RANGe.....	83
[SOURce:]CURRent[:LEVel][:IMMediate][:AMPLitude].....	82
[SOURce:]POWer:PROTection:CLEar.....	96
[SOURce:]POWer:PROTection:LEVel.....	95
[SOURce:]POWer:PROTection:TRIPped?.....	96
[SOURce:]POWer:PROTection[:STATe].....	96
[SOURce:]VOLTage:PROTection:CLEar.....	94
[SOURce:]VOLTage:PROTection:LEVel.....	94
[SOURce:]VOLTage:PROTection:MODE.....	93
[SOURce:]VOLTage:PROTection:TRIPped?.....	93
[SOURce:]VOLTage:PROTection[:STATe].....	93
[SOURce:]VOLTage:RAMP:DURation.....	100
[SOURce:]VOLTage:RAMP[:STATe].....	100
[SOURce:]VOLTage:SENSe.....	80
[SOURce:]VOLTage[:LEVel][:IMMediate][:AMPLitude].....	81
*CLS.....	74
*ESE.....	74
*ESR?.....	74
*IDN?.....	75
*OPC.....	75
*OPT?.....	75
*RST.....	75
*STB?.....	75
*WAI.....	75
APPLY.....	83
ARBitrary:CLEar.....	98
ARBitrary:DATA.....	98
ARBitrary:POINts?.....	99
ARBitrary:RCL.....	98
ARBitrary:REPetitions.....	98
ARBitrary:SAV.....	99
ARBitrary:STARt.....	99
ARBitrary:STOP.....	100
ARBitrary[:STATe].....	99
DATA:DATA?.....	106
DATA:LIST?.....	106
DIAGnostic:SERVice:FWUP.....	106
FUSE:DELay.....	89
FUSE:LINK.....	89
FUSE:TRIPped?.....	90
FUSE:UNLink.....	90
FUSE[:STATe].....	90
HCOPY:DATA?.....	105
HCOPY:SIZE:X?.....	105
HCOPY:SIZE:Y?.....	105
INSTrument:NSElect.....	79
INSTrument[:SElect].....	80

LOG[:STATe].....	105
MEASure[:SCALar]:CURRent[:DC]?.....	97
MEASure[:SCALar]:POWer?.....	97
MEASure[:SCALar][:VOLTage][:DC]?.....	97
OTP:TRIPped?.....	87
OUTPut:FUSion.....	85
OUTPut:GENeral.....	85
OUTPut:MODE?.....	86
OUTPut:SElect.....	86
OUTPut[:STATe].....	84
SYSTem:BEEPer[:IMMediate].....	76
SYSTem:COMMunicate:SOCKet:DHCP[:STATe].....	77
SYSTem:COMMunicate:SOCKet:IPADdress?.....	77
SYSTem:COMMunicate:WLAN:CONNect.....	77
SYSTem:COMMunicate:WLAN:DISConnect.....	78
SYSTem:COMMunicate:WLAN:IPADdress?.....	78
SYSTem:COMMunicate:WLAN:PASSword.....	78
SYSTem:COMMunicate:WLAN:SSID.....	78
SYSTem:COMMunicate:WLAN[:STATe].....	78
SYSTem:LOCal.....	76
SYSTem:OPTion?.....	76
SYSTem:REMote.....	76
SYSTem:RWLock.....	76
SYSTem:TEST:BEEPer.....	77
SYSTem:TEST:FANCtrl.....	77
SYSTem:TEST:KEYBacklight.....	77
SYSTem:TEST:SCReen.....	77
TRIGger:DIRection:DIO<IO>.....	100
TRIGger:IN:ARBitrary:DIO<IO>.....	101
TRIGger:IN:RESPonse:DIO<IO>.....	101
TRIGger:IN:SOURce:DIO<IO>.....	102
TRIGger:LOGic:DIO<IO>.....	102
TRIGger:MASTer[:STATe].....	102
TRIGger:OUT:CONDition:DIO<IO>.....	103
TRIGger:OUT:CRITevent:DIO<IO>.....	103
TRIGger:OUT:CURRlevel:DIO<IO>.....	104
TRIGger:OUT:SOURce:DIO<IO>.....	104
TRIGger:OUT:VOLTlevel:DIO<IO>.....	104
TRIGger:RCL.....	104
TRIGger:SAV.....	105
TRIGger[:ENABLE]:DIO<IO>.....	101

Index

A

Activate channel output	39
Activating fuse	44

B

Bottom panel	
Voltage selector	21
Voltage selector label	21

C

Calibration certificate	7
Channel display area	
Operating mode	28
Channel fusion	42
Clear status	
Remote	74
Command sequence	
Remote	75
Command sequence and synchronization	115
Controls	18
Current range setting	40
Customer support	25

D

Data logging	51
Default values	
Remote	75
Digital IO	48
Display overview	26
Channel display area	27
Status bar information	26
Documentation overview	7

E

EasyArb	52
EasyRamp	54
Event status enable register (ESE)	
Remote	74
Event status register (ESR)	
Remote	74

F

Front panel	
Display	18
Function keys	18
Output channels	18
Power key	18
Rotary knob and arrow keys	18
USB connector	18
Front panel keys	28
Output and channel controls	29
Fuse	45
Fuse delay	45
Fuse linking	45
FuseLink	45

G

General instrument settings	66, 67
Buzzer	67
Display	67
Display brightness	67
Key fallback time	67
Keypad	67
Sound	67
Getting Started	7

H

Help	72
------------	----

I

Identification	
Remote	75
Important notes	
Ambient conditions	10
Limits	12
Mains voltage	11
Measurement categories	11
Symbols	10
Information	66
Interfaces and protocols	57
Network connection	57

M

Maintenance	
Cleaning	24
Menu	32
Menu controls	28
Message and command structure	
Messages	111
SCPI command structure	112
Mode	
Operation modes	36

N

Navigation controls	
Arrow keys	31
Rotary knob	31
Network	
LAN	58
USB	61
Wireless LAN	60

O

On-screen keyboard	34
Open source acknowledgment (OSA)	8
Operation complete	
Remote	75
Operation modes	
Constant current (CC)	37
Constant voltage (CV)	36
Options	67
Identification (remote)	75
Install option	67
Installation status	67

Output	
Remote sense	41
Output and channel controls	29
P	
Package contents	16
Power derating	35
Protection	46
Overpower protection (OPP)	46
Overvoltage protection (OVP)	46
R	
Rear panel	
AC inlet with fuse holder	20
Digital I/O connector	20
Ethernet connector	20
USB connector	20
Voltage selector	20
Release notes	8
Remote control commands	
Remote sense commands	80
Remote sense function	41
Reset	68
Reset values	
Remote	75
S	
Safety instructions	7
Selecting the channels	38
Setting up the instrument	
Bench operation	17
Rack mounting	17
Status bar information	
Channel status bar	27
Device status bar	26
Status byte	
Remote	74, 75
Store and recall	55
Switching off the instrument	22
Switching on the instrument	22
System date time	72
System test	70
T	
Tracking function	46
Trying out the instrument	
Activating the channels output	23
Selecting the channels	23
Setting the output voltage and Current limit	23
Storing/Recalling of instrument settings	23
U	
Unpacking and checking the instrument	16
Update	70
User manual	7
W	
Wait	
Remote	75