



---

# USER MANUAL

## Moisture Meter and Thermal Imager with MSX®

Model MR265





---

# **USER MANUAL**

## **Moisture Meter and Thermal Imager with MSX<sup>®</sup>**



# Table of contents

---

<b>1</b>	<b>Advisories</b> .....	<b>1</b>
	1.1 Copyright.....	1
	1.2 Quality Assurance .....	1
	1.3 Documentation .....	1
	1.4 Disposal of Electronic Waste.....	1
<b>2</b>	<b>Introduction</b> .....	<b>2</b>
<b>3</b>	<b>Safety</b> .....	<b>4</b>
	3.1 Safety Warnings and Cautions.....	4
<b>4</b>	<b>Descriptions</b> .....	<b>5</b>
	4.1 Product Description.....	5
	4.2 Control Button Descriptions .....	6
	4.3 Display Description .....	6
<b>5</b>	<b>User Interface Menus</b> .....	<b>8</b>
	5.1 Menu Structure Overview .....	8
	5.2 Main Menu Icons .....	8
	5.3 Temperature Scale Menu .....	9
	5.4 Image Mode Menu.....	10
	5.5 Measurement Menu .....	12
	5.6 Moisture Modes Menu .....	14
	5.7 Colour Menu.....	16
	5.8 Settings Menu.....	17
<b>6</b>	<b>Powering the MR265</b> .....	<b>25</b>
<b>7</b>	<b>Moisture Measurement Operation</b> .....	<b>26</b>
	7.1 Moisture Measurement Basics .....	26
	7.2 Moisture Display Options.....	27
	7.3 IGM™ Moisture and IGM™ Custom Modes.....	29
	7.4 Moisture Measurement Modes .....	30
	7.5 Pinless Moisture Measurements .....	32
	7.6 Pin Probe Measurements .....	33
	7.7 MR12 Ball Moisture Probe (Optional).....	34
	7.8 Set Reference Mode .....	34
	7.9 High Moisture Alarm.....	35
<b>8</b>	<b>Thermal and Visible Camera Operation</b> .....	<b>37</b>
	8.1 Thermal Camera .....	37
	8.2 Automatic/Lock Temperature Scaling .....	38
	8.3 Digital (Visible) Camera .....	39

## Table of contents

---

8.4	High/Low IR Temperature Alarm.....	39
<b>9</b>	<b>Capturing and Working with Images .....</b>	<b>41</b>
9.1	Capturing Images .....	41
9.2	Viewing Images on the MR265 .....	41
9.3	Deleting images .....	41
9.4	Image Information.....	41
9.5	Transferring Images via PC Interface.....	41
<b>10</b>	<b>Field Firmware Updates .....</b>	<b>43</b>
10.1	System Firmware Update .....	43
<b>11</b>	<b>Maintenance .....</b>	<b>44</b>
11.1	Cleaning.....	44
11.2	Battery Service .....	44
11.3	Disposal of Electronic Waste .....	44
11.4	MR265 Crash Recovery .....	44
<b>12</b>	<b>Specifications.....</b>	<b>45</b>
12.1	General Specifications.....	45
12.2	Thermal Imaging Specifications .....	46
12.3	Moisture Measurement Specifications.....	46
12.4	Visible Spectrum Camera Specifications.....	47
12.5	Safety Specifications .....	47
<b>13</b>	<b>Appendices .....</b>	<b>48</b>
13.1	Material Groups .....	48
	13.1.1 Common names of timbers .....	48
	13.1.2 Botanical names of timbers .....	51
13.2	%WME Table (% Wood Moisture Equivalent) .....	54
<b>14</b>	<b>Limited 10–Year Warranty .....</b>	<b>56</b>
<b>15</b>	<b>Customer Support.....</b>	<b>57</b>

# 1 Advisories

---

## 1.1 Copyright

©2021 FLIR Systems, Inc. All rights reserved worldwide.

No parts of the software including source code may be reproduced, transmitted, transcribed or translated into any language or computer language in any form or by any means, electronic, magnetic, optical, manual or otherwise, without the prior written permission of FLIR Systems.

The documentation must not, in whole or part, be copied, photocopied, reproduced, translated or transmitted to any electronic medium or machine-readable form without prior consent, in writing, from FLIR Systems. Names and marks appearing on the products herein are either registered trademarks or trademarks of FLIR Systems and/or its subsidiaries. All other trademarks, trade names or company names referenced herein are used for identification only and are the property of their respective owners.

## 1.2 Quality Assurance

The Quality Management System under which these products are developed and manufactured has been certified in accordance with the ISO 9001 standard. FLIR Systems is committed to a policy of continuous development; therefore, we reserve the right to make changes and improvements on any of the products without prior notice.

## 1.3 Documentation

To access the latest manuals and notifications, go to the Download tab at: <https://support.flir.com>. It only takes a few minutes to register online. In the download area you will also find the latest releases of manuals for our other products, as well as manuals for our historical and obsolete products.

## 1.4 Disposal of Electronic Waste



As with most electronic products, this equipment must be disposed of in an environmentally friendly way, and in accordance with existing regulations for electronic waste. Please contact your FLIR Systems representative for more details.

# 2 Introduction

---

Thank you for selecting the FLIR MR265. The MR265 integrates high quality thermal imaging and digital camera technology with best-in-class moisture detection and measurement. The MR265 includes an integrated noninvasive pinless moisture sensor (on back of meter) and an external pin moisture probe (MR02).

The MR265 features Infrared Guided Measurement (IGM™) technology that allows you to quickly scan and target problem areas. The MSX® feature (Multi-Spectral Dynamic Imaging) superimposes the digital camera image on the thermal image providing valuable image detail.

The MR265 stores up to 15,000 radiometric JPEG camera images for viewing on the display and for transferring to a PC (via USB).

Using FLIR Thermal Studio™ (not supplied), you can create and share professional reports with customers or partners based on the measurements and images you've captured.

Visit <https://support.flir.com> to find additional accessories and to register the MR265.

## Features








- FLIR Lepton® microbolometer Focal Plane Array (FPA) with integrated shutter delivers best-in-class thermal imaging
- Quickly scan for moisture using the integrated noninvasive pinless moisture sensor
- External pin probe (included) for resistive moisture content measurements
- IGM™ Moisture mode shows both the thermal image and moisture readings on one screen
- MSX® feature superimposes the digital camera image on the thermal image
- Moisture-only mode shows Pin or Pinless moisture readings in large-digit format
- Temperature Scale Lock adds precision to thermal image scanning
- Easily capture, view, download (to PC), and delete camera images
- Selectable material groups allow you to fine tune pin-based measurements
- Programmable Moisture and IR Temperature alarm with audible and colour-coded display alerts
- Laser pointer and display cross hairs for enhanced targeting



- Easy to read, colour display with intuitive graphical interface and tool tips in local languages
- Internal rechargeable battery via USB connection to AC charger

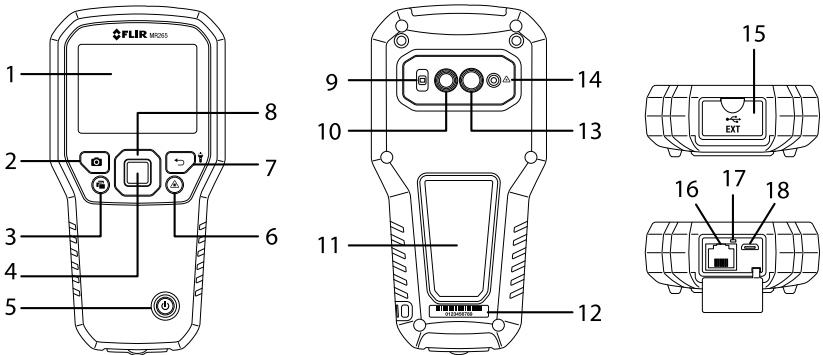
# 3 Safety

## 3.1 Safety Warnings and Cautions

	<b>WARNING</b>
Before operating this device, please read, understand, and follow all operational instructions and safety warnings.	
	<b>CAUTION</b>
Use of controls or adjustments or performance of procedures other than those specified herein may result in hazardous radiation exposure.	
	<b>CAUTION</b>
Use extreme caution when the Laser pointer is on.	
	<b>CAUTION</b>
Do not point the Laser beam toward anyone's eye or allow the beam to strike the eye from a reflective surface.	
	<b>CAUTION</b>
Do not use the Laser near explosive gases or in other potentially explosive areas.	
	<b>CAUTION</b>
Refer to the CAUTION statement label (shown below) for critical Laser safety information.	
	

# 4 Descriptions








## 4.1 Product Description



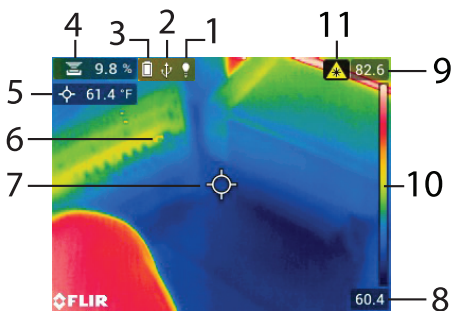
**Figure 4.1** Front, Back, and Bottom Product Description

1. Colour Graphical Display
2. Image Capture button
3. Image Gallery button
4. *Select* button (centre). Press to open Menu
5. Power button
6. Laser Pointer button
7. *Return* and Worklight button
8. Navigation buttons (UP, DOWN, LEFT, RIGHT)
9. Worklight lens
10. Digital camera lens
11. Pinless moisture sensor pad
12. Serial number label
13. Thermal camera lens
14. Laser pointer lens
15. External probe and USB connector compartment
16. External moisture probe socket
17. Battery charging LED
18. USB socket for connecting to PC or AC Charger

## 4.2 Control Button Descriptions

	Long press to power ON or OFF.
	Return button. Short press to return to previous screen in Menu.
	Long press to switch Worklight ON or OFF.
	Press the <i>Select</i> button (centre) to access the Main Menu, to select items in the menu system, and to see the battery status icon. Use the outer navigation (ring) buttons to move Up-Down-Left-Right.
	Press to switch the Laser pointer ON.
	Press to capture screen image.
	Press to open image gallery.

## 4.3 Display Description



**Figure 4.2** MR265 Select Display Descriptions

1. Worklight icon
2. Active USB communication icon
3. Battery status icon
4. Moisture reading with sensor type icon
5. Temperature of targeted centre spot (cross hairs)
6. IR Thermal image
7. Cross-hairs (Centre Spot)
8. Low end of IR image temperature range

9. High end of IR image temperature range

10. Temperature scale



11. Laser pointer active icon

**NOTE**

Not all icons are represented in Figure 4-2. Other available icons are explained in their respective sections of this user manual.

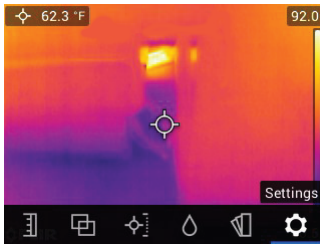
# 5 User Interface Menus

## 5.1 Menu Structure Overview







When the *Select* button  is pressed, six menu icons appear along the bottom of the MR265 display. Use the left/right navigation buttons to move to a menu icon, and use the *Select* button to open a selected menu. Once a menu is opened, the navigation and *Select* buttons are used to select modes of operations and settings. Use the *Return* button  to back out of a menu.

## 5.2 Main Menu Icons

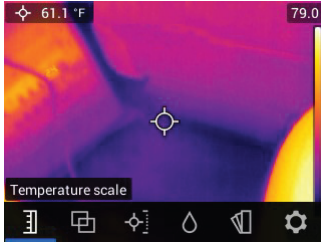
From left to right, the six main menu icons are listed below and shown in **Figure 5-1**. Each menu is described in detail in the next sections.



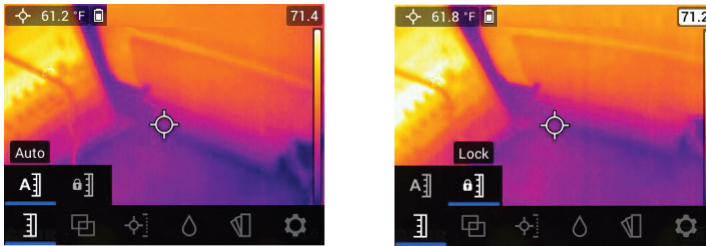
**Figure 5.1** Main Menu icons at bottom of display. Press *Select* to reveal the icons.

1. Temperature scale 
2. Image modes 
3. Measurement modes 
4. Moisture modes 
5. Colour (palette) choices 
6. Settings menu 


### 5.3 Temperature Scale Menu



**Figure 5.2** Accessing the Temperature Scale Menu



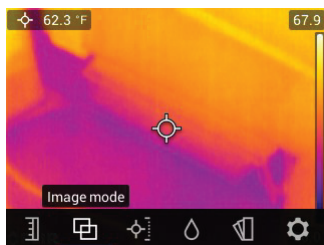
**Figure 5.3** Selecting AUTO or LOCK Scaling

The Temperature scale menu allows you to select Automatic (Auto) or Lock scaling. Use the navigation buttons to move to the desired setting and then press *Select*  to confirm.

In Automatic mode, the MR265 automatically selects the temperature range for each thermal image, based on the highest and lowest temperatures detected. In Lock mode, you can 'lock in' a particular thermal image's temperature range and use this locked range for subsequent thermal image comparisons. This locked range does not change, regardless of the highest and lowest temperatures detected for the subsequent images. See **Section 8–2 Automatic and Lock Scaling** for more information.

To release the Lock mode, simply select the Auto mode as described above.

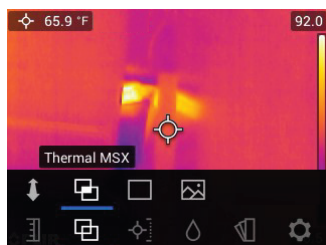
## 5.4 Image Mode Menu




**Figure 5.4** Image Mode Menu

The Image Mode Menu offers five sub-menus as described below.

- **Thermal MSX® mode:** Select this mode to see the digital camera image superimposed over the thermal camera image. Use the Alignment Distance menu (next section) to align the digital and thermal images.



**Figure 5.5** Thermal MSX® selection

- **Alignment Distance control:** This control allows you to adjust the superimposition of the visible image over the thermal image. Press *Select*  on the Alignment Distance menu to open it, and then use the navigation buttons to adjust the alignment. Press *Select* to confirm the change.



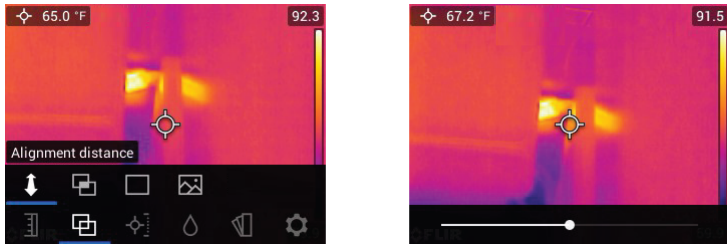


Figure 5.6 Alignment Distance Control screens

- **Thermal mode:** Select this mode to see the thermal image only.

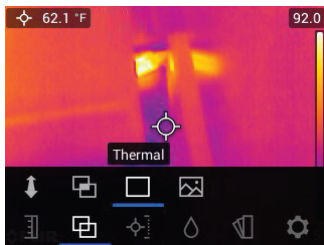


Figure 5.7 Thermal IR Image mode

- **Digital Camera mode:** Select this mode to see only the visible camera image.

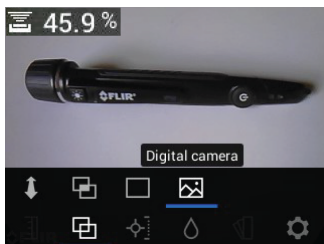


Figure 5.8 Digital Camera mode selection

- **Moisture mode:** Select this mode to see only the moisture reading in large digit format.

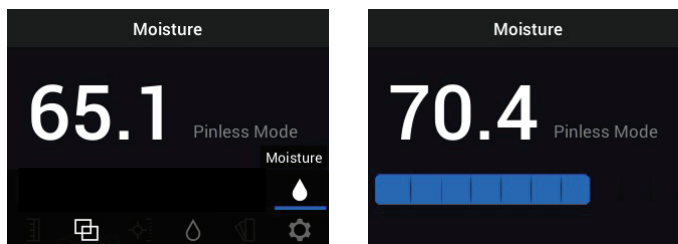


Figure 5.9 Moisture mode selection and example screen

## 5.5 Measurement Menu

The Measurement Menu offers four sub-menus as described below.

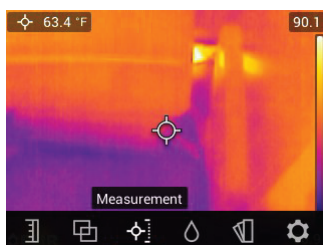


Figure 5.10 Selecting the Measurement mode from the main menu

- **No Measurements:** Select this mode if you do not wish to see any measurement values or icons on the display. Only the camera image will be seen in this mode.

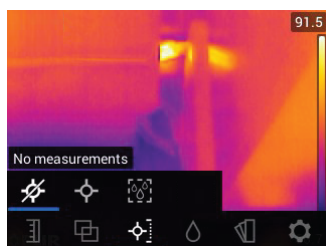
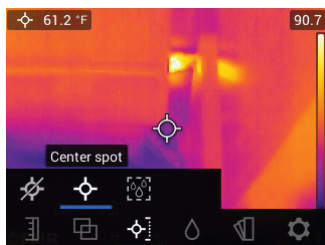


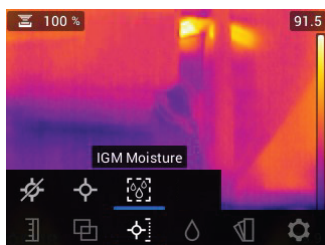
Figure 5.11 Selecting the 'No Measurement' mode from the main menu

- **Centre Spot** (cross-hairs): Enable this mode to view the temperature measurement of the targeted spot in the upper left hand corner of the display. Use the cross-hairs to target the measurement spot.



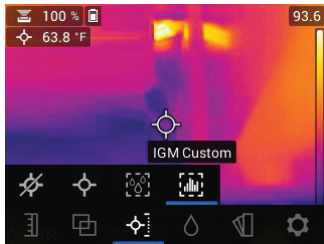
**Figure 5.12** Selecting the 'Centre Spot' mode from the main menu

- **IGM™ Moisture mode**: Select this mode to view the moisture measurements on the upper left hand corner of the display. The IGM™ mode (Infrared Guided Measurement) is best suited for first scanning an area for temperature measurements and then taking moisture measurements in the strategic areas identified by the temperature measurements.



**Figure 5.13** Selecting the IGM™ Moisture mode from the main menu

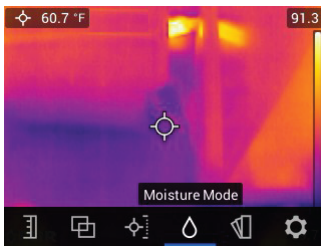
- **IGM™ Custom mode**: Select this mode to view all of the measurement types on the MR265 that you enable in the **Settings** menu (see **Section 5.8**).



**Figure 5.14** Selecting the IGM™ Custom mode from the main menu

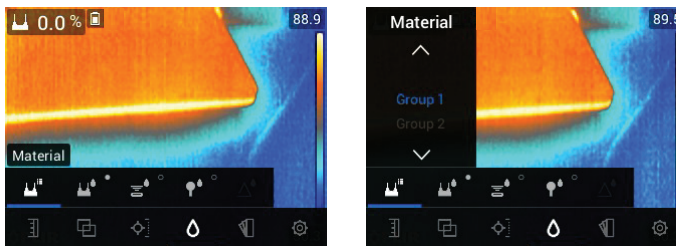
## 5.6 Moisture Modes Menu

The Moisture Mode Menu offers five sub-menus as described below.



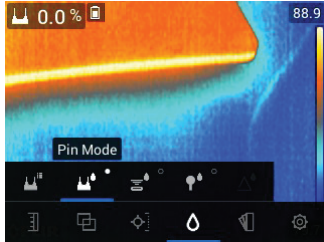
**Figure 5.15** Opening the Moisture Mode menu

- Material Group selection:** This mode is only available when the pinless mode is selected (below). Select Group 1 through Group 11 depending on the material under test. See **Section 13 Appendices** for the Material Group selection tables that help you select the correct group number.



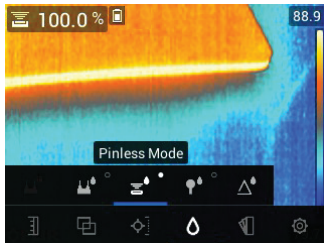
**Figure 5.16** Selecting a Material Group for pin-based moisture measurements

- **Pin mode:** Select this mode when using an external pin probe. See **Section 7.6 External Pin Probe Measurements** for more information.



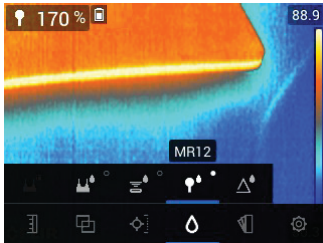
**Figure 5.17** Selecting pin-based measurement mode

- **Pinless mode:** Select this mode when using the pinless sensor (rear of MR265). See **Section 7.5 Pinless Moisture Measurements** for more information.



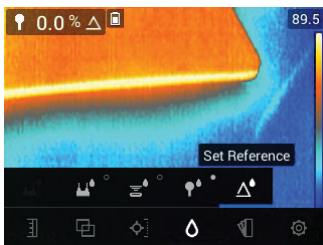
**Figure 5.18** Selecting the pinless measurement mode

- **MR12 mode:** Select this mode when using the optional MR12 Ball Moisture probe accessory. The MR12 attaches to the socket on the bottom of the MR265. See **Section 7.7 MR12 Ball Moisture Probe** for more information.



**Figure 5.19** Selecting the MR12 (optional moisture probe) mode

- Set Reference mode:** This utility is only available when using the built-in pinless sensor (rear of MR265) or the remote MR12 Ball Moisture probe. After selecting the pinless mode (or the MR12 mode) and while taking a moisture measurement, select the 'Set Reference' utility to zero the current measurement value (the delta symbol will appear to inform you that the Set Reference mode is active). Now, subsequent moisture measurements can be made relative to the original 'Set Reference' value. To release the Set Reference utility, select the pin mode. See **Section 7.8 Set Reference Mode** for additional information.



**Figure 5.20** Selecting the reference value in which to compare subsequent measurements

## 5.7 Colour Menu

The colour menu allows you to select from five display palettes. Iron, Rainbow, White hot, Black hot, and Arctic.

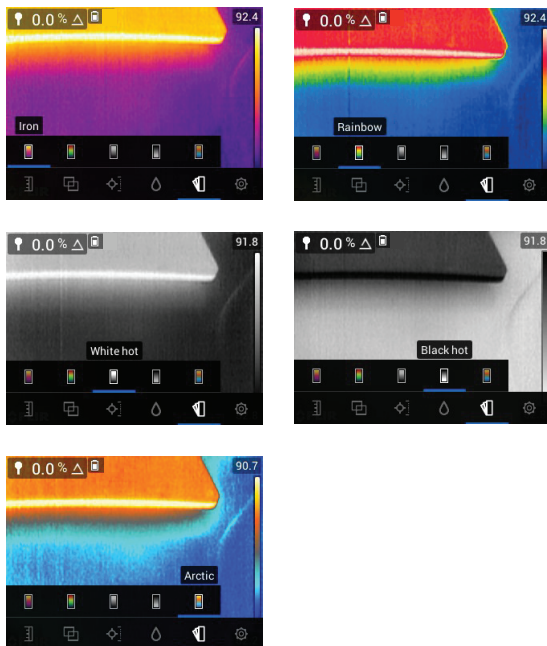


Figure 5.21 Colour palette selections

## 5.8 Settings Menu

The Settings menu offers the following options:

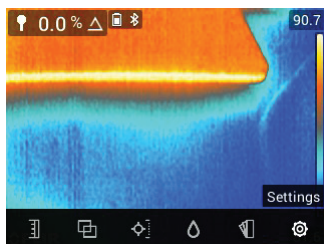
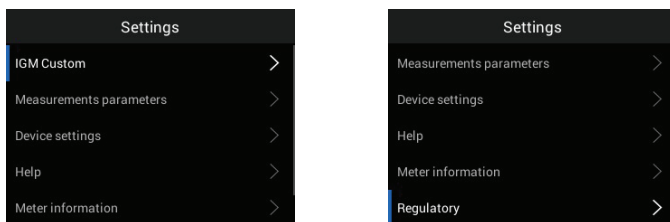
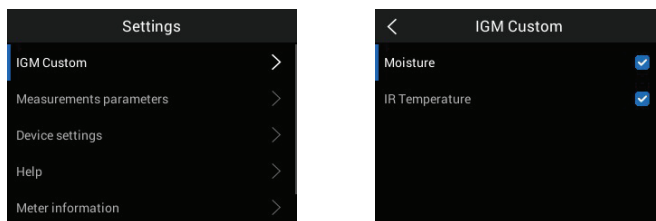


Figure 5.22 Selecting the 'Settings' mode from the main menu



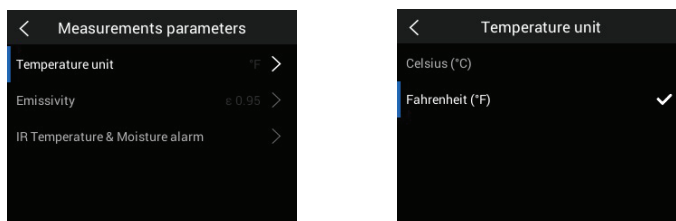
**Figure 5.23** Settings menu items

- **IGM™ Custom mode:** Select the readings that you wish to display when the IGM™ Custom Mode is enabled in the Measurement Menu, **Section 5.5**.



**Figure 5.24** IGM™ Custom mode selections. Pick the items to display in the IGM™ Custom mode

- **Measurement Parameters:** Use the **Measurement Parameters** menu to set the Temperature Units, Emissivity factor, and IR Temperature & Moisture Alarms. These are explained below:
- **Temperature units selection:** Select °C or °F.



**Figure 5.25** Selecting temperature units of measure

- **Emissivity selection:** Select an emissivity preset or choose a custom setting. See screen examples below:



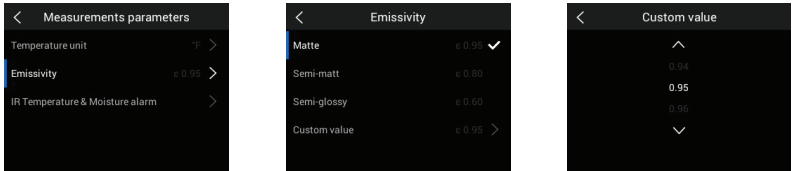


Figure 5.26 Selecting the Emissivity

- IR Temperature & Moisture Alarms:** Set the IR Temperature Alarm to ABOVE, BELOW, or OFF. When an IR Temperature alarm is set to ABOVE or BELOW, the MR265 will alert you when the IR Temperature exceeds the high limit (temperature display turns red) or falls below the low limit (temperature display turns blue). When an IR Temperature alarm is set to OFF, the alarm is disabled.

Set the Moisture Alarm to ABOVE or OFF. When a Moisture alarm is set to ABOVE, the MR265 will alert you when the moisture measurement exceeds the high limit (moisture reading turns red and beeper sounds, if enabled). When a Moisture alarm is set to OFF, the alarm is disabled. The Moisture alarm utility also allows you to select BEEP or NO SOUND for the alarm alert. See **Section 7.9 High Moisture Alarm** and **Section 8.4 High/Low IR Temperature Alarms** for more information.

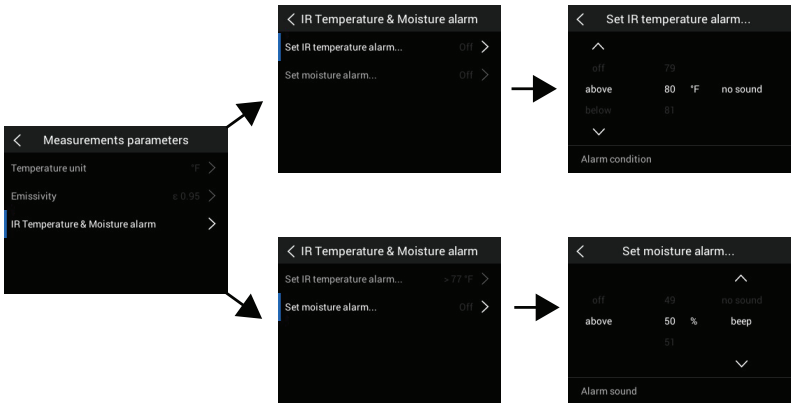

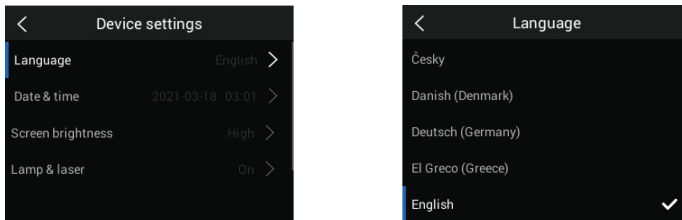


Figure 5.27 Setting IR Temperature and Moisture Alarms

- **Device Settings:** Use the Device Settings menu to set the following parameters: Language, Date & Time, Screen Brightness, Lamp (Worklight) & Laser pointer, Auto Power Off, and Reset (factory default reset, internal memory formatting, and PIN calibration). These are explained below.
- **Language selection:** Use the navigation arrows and *Select* button  to choose the desired display language.



**Figure 5.28** Local language selections

- **Date and time setting:** Set the year, month, day, hours, and minutes.



Figure 5.29 Setting the Date and Time

- **Screen Brightness:** Set the screen brightness as shown in the screen images below.

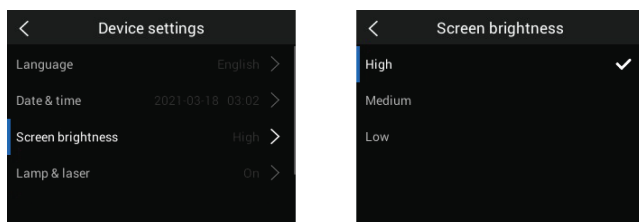


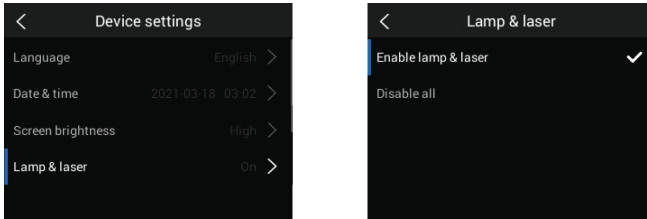


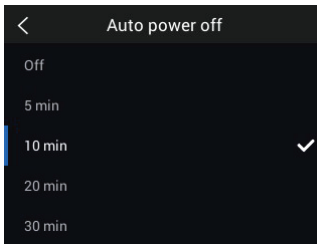
Figure 5.30 Setting the Screen Brightness

- **Lamp and Laser Enable/Disable:** Enable or disable both the Worklight and Laser pointer. When enabled, press and hold the Worklight button  to turn the Worklight ON or OFF. When enabled, press the Laser button  to turn the Laser pointer ON (release the button to turn it OFF).



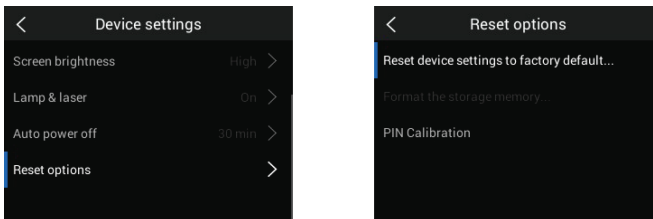
**Figure 5.31** Enabling/Disabling the Laser pointer and the Worklight

- **Auto Power OFF (APO):** Set APO to a time value of 5, 10, 20, or 30 minutes. Set to OFF to disable APO.



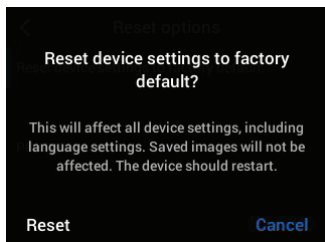
**Figure 5.32** Setting the Auto Power Off (APO) utility

- **Reset options:** Access this menu to reset the MR265 to factory default conditions, to format (erase) the internal image memory, and to perform a PIN Calibration. To recover from a MR265 crash (display freezes), press and hold the UP and DOWN arrows for >10 seconds, until the MR265 re-boots. No data will be lost by running this procedure.



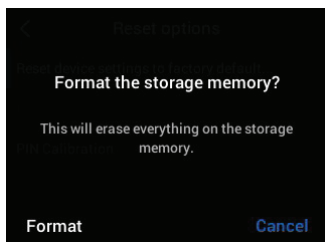
**Figure 5.33** Reset options screen

- **Set Device Settings to Factory Default:** Select RESET to perform the reset, or select CANCEL to abort.

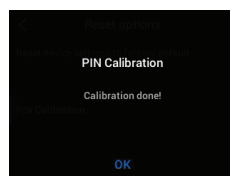
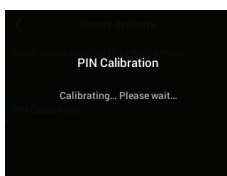
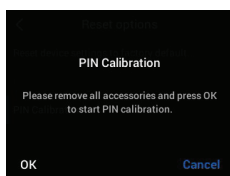


**Figure 5.34** Reset to Factory Default conditions

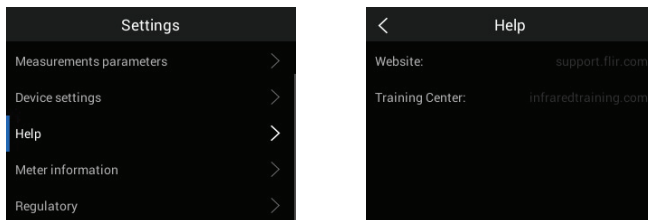
- **Format the Storage Memory:** Erase all captured images from the internal memory.



- **PIN Calibration:** When the pins are replaced in a pin probe, if the entire probe is replaced, or to simply ensure the highest accuracy, please perform a PIN calibration.

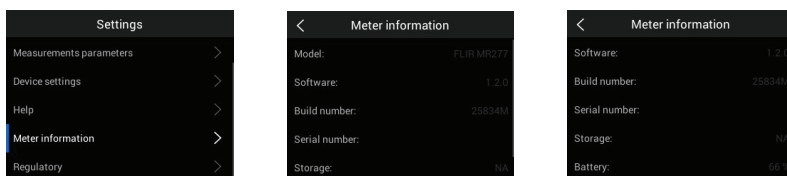


- **HELP Resources:** Access this menu to view customer support and training resources.



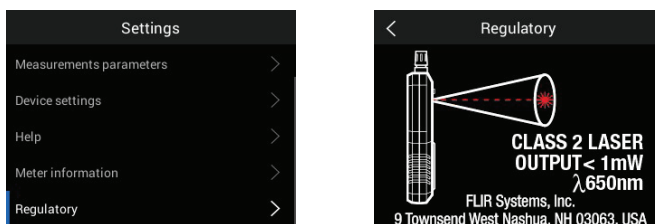
**Figure 5.35** Viewing the Customer Support resources

- **Meter Information:** Access this menu to see Model number, Software version, Build number, Serial number, Data storage availability, and Battery status.



**Figure 5.36** Checking the meter information screen




- **Regulatory information:** Access this menu to view Laser safety information.



**Figure 5.37** Viewing safety information for the Laser pointer

# 6 Powering the MR265


---

1. Long press the Power button  to switch the meter ON. The FLIR logo will appear and the meter will proceed to power up. Long press again to power OFF.
2. If the battery status indicator  shows that the battery voltage is low or if the meter does not power ON, charge the battery by connecting the meter to an AC charger using the supplied USB cable. When the MR265 is not charging, the battery status indicator is only visible from the Main Menu (press *Select*  to access the Main Menu). While charging, the battery status indicator is always visible. Note that there is an indicator in the bottom compartment, next to the USB port, that illuminates when the MR265 is charging.  
The battery status, as a percentage, is shown in the Settings menu, under the Meter Information sub-menu.
3. The meter switches OFF automatically after a programmed period of inactivity (unless APO is set to OFF in the 'Settings' menu, see **Section 5.8 Settings Menu** for more information). Press any button to reset the APO timer when you hear the three warning beeps. If no buttons are pressed during the warning beeps, the MR265 will power OFF. To disable APO, or to change the APO timer value, edit the APO parameter in the 'Settings' menu.
4. The internal battery is not user-serviceable. If you find that the battery will not charge, see **Section 11.2 Battery Service** for further instructions and to learn about the proper charging techniques for when the meter is to be stored for extended periods. Failure to follow these instructions can result in a battery that cannot be charged and that will require factory service.

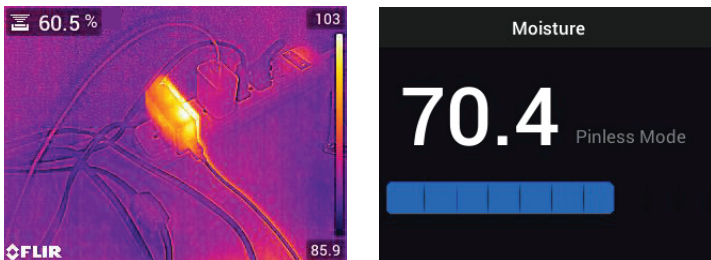
# 7 Moisture Measurement Operation

## 7.1 Moisture Measurement Basics

Moisture measurements are performed using the internal pinless moisture sensor (rear) or by connecting an external probe, such as the supplied MR02 pin probe or the pinless MR12 Ball Moisture probe, to the socket at the bottom of the meter. Other external probes are available optionally; please visit the FLIR website for details. The MR265 has a dedicated MR12 utility where you connect the probe and select the MR12 icon in the 'Moisture Mode' menu: *Select button/Moisture Mode/MR12*.

	<b>NOTE</b>
Objects in close proximity to the internal pinless moisture sensor (rear of the unit) will affect measurements; keep hands and objects away from the sensor when taking measurements.	




Moisture readings are shown in large digits and bar graph in the Moisture-only mode or in small digits (upper left hand corner) in all other modes, see **Section 5-4 Image Mode Menu** for additional information. See **Figure 7-1** below for screen shot examples.



**Figure 7.1** Moisture reading upper left corner (LEFT); Moisture reading in Moisture-only mode (RIGHT)

Pinless measurement readings are 'relative' scaled (0~100). Pin-based readings are represented in %MC (moisture content) for wood and %WME (wood moisture equivalent) for non-wood materials; additional information is provided in **Section 7-6, Pin Probe Moisture Measurements** and in the *Specifications* section.

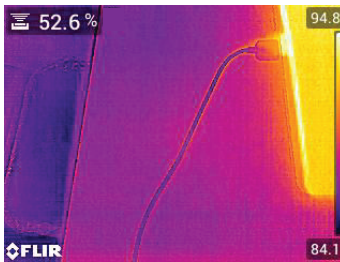


Moisture measurements are covered in detail in the following sections. Be sure to select Pin Mode  or Pinless Mode  in the 'Moisture' menu  to match the measurement type.

## 7.2 Moisture Display Options

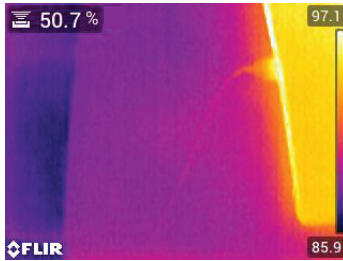
View moisture readings in two basic ways. **1.** Moisture readings as large digits in the Moisture-only mode or **2.** Moisture readings in small digits in the upper left hand corner of a thermal or visible camera image. Choose the desired mode in the menu (*Image Mode*). Refer to the information below and to **Section 5-4 Image Modes** for additional details.

- **Thermal MSX® mode** (Multi-Spectral Dynamic Imaging). The digital camera image is superimposed on the thermal image to give greater detail to the thermal image. The moisture reading can be seen on the upper left. See **Section 5-4 Image Modes** for aligning the digital camera image over the thermal image (Alignment Distance Control).



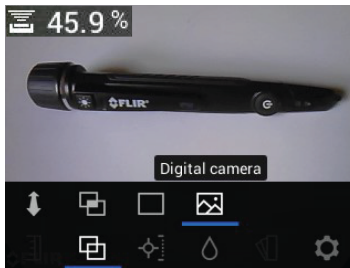
**Figure 7.2** Thermal MSX® mode with Moisture reading in the upper left corner

- **Thermal Mode.** This is the thermal image only. The moisture reading can be seen on the upper left.



**Figure 7.3** Thermal mode with Moisture reading in the upper left corner

- **Digital Camera:** This is the digital camera image only. The moisture reading can be seen on the upper left.



**Figure 7.4** Digital Camera mode with Moisture reading in the upper left corner

- **Moisture mode.** This is a dedicated display for moisture only. Large digits and a bar graph are used in this mode for easy viewing. Additional features in this mode include colour coded alarm alert (see **Section 7.9 High Moisture Alarm**) and relative readings (see **Section 7.8 Set Reference**).

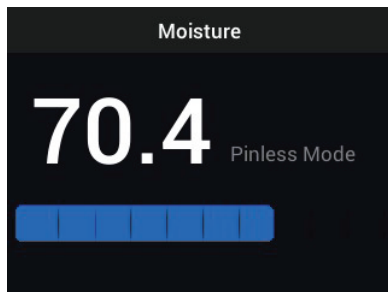



Figure 7.5 Moisture-only display mode

### 7.3 IGM™ Moisture and IGM™ Custom Modes

In the **IGM™ Moisture** mode  you can view a camera image with the Moisture reading appearing on the upper left. Select this mode in the menu (*Measurement/IGM™ Moisture*). IGM™ stands for 'Infrared Guided Measurements'. The Pin or Pinless display icon will appear next to the reading. To take full advantage of this feature, scan for temperature variations, and use this feedback to help you find areas of high moisture. For additional information see **Section 5.5 Measurement Menu**.

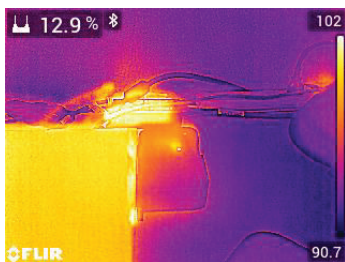

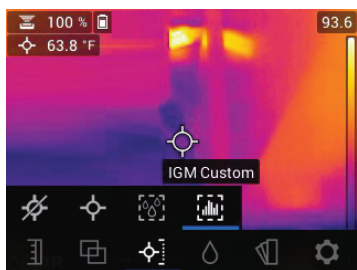


Figure 7.6 IGM™ mode with Moisture reading shown on upper left



In the **IGM™ Custom** mode , you can view IR Temperature and Moisture readings at the same time or only one of the two. To customize this display, use the Settings menu, **Section 5.8**, (*Settings/IGM™ Custom*).

For additional information see **Section 5.5 Measurement Menu**.





**Figure 7.7** IGM™ Custom mode with Moisture and IR Temperature readings on upper left

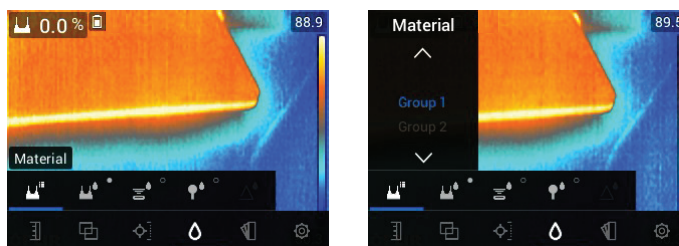
## 7.4 Moisture Measurement Modes

Press the **Select**  button to open the Main Menu, choose the 'Moisture' mode , and then select from the four Moisture mode options as described below.

- **Material Groups**


Select a Material Group that best matches the material under test. This applies only for external pin-based probe use. Use the menu to make a selection (*Moisture Mode/Material* ).

Use the Navigation arrows to scroll through the Material list and press **Select**  to choose the Group number. See the Material Group tables in **Section 13 Appendices**, these tables will help you decide which Material Group to select.



**Figure 7.8** Selecting a Material Group in the 'Moisture' menu

- **Pin Mode**

PIN mode must be selected in the menu (*Moisture mode* ) when an external pin-based probe is used. Note the pin icon on the upper left of the main display when selected. Pin-based readings are represented in %MC (moisture content) for wood and %WME (wood moisture equivalent) for materials other than wood.

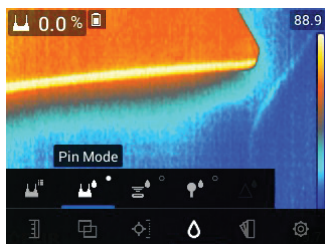



Figure 7.9 Pin mode menu selection

- **Pinless Mode**

Pinless mode must be selected in the menu when using the internal sensor (*Moisture mode* ) ). Note the pinless icon on the upper left of the main display when selected. Pinless measurement readings are 'relative' scaled (0~100).

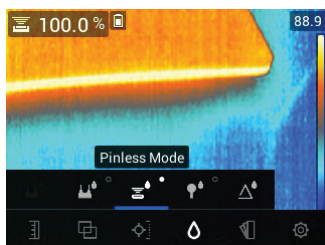


Figure 7.10 Pinless mode selection

- **MR12 Mode**

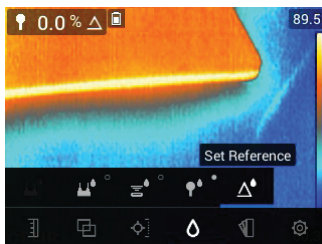
MR12 mode must be selected when the optional MR12 Ball Moisture probe is used. Connect the MR12 to the accessory socket on the bottom of the MR265 (under the protective flap) and then select the MR12 from the Moisture Mode menu as shown in **Figure 7-11**.



**Figure 7.11** Selecting the MR12 (optional Ball Moisture probe) mode

- **Set Reference Mode**

'Set Reference' is used to compare measurements to a stored reference value. This mode applies only to readings taken with the pinless internal sensor or the external MR12 Ball Moisture probe. The moment the Set Reference mode is selected, the current reading is offset to zero. Subsequent readings will be offset by this same amount, see **Section 7.8 Set Reference Mode** for additional information.



**Figure 7.12** Selecting the 'Set Reference' mode.

## 7.5 Pinless Moisture Measurements

- Select the pinless mode from the menu system (*Moisture mode/Pinless*); see **Figure 7-10**.
- Press the rear sensor pad firmly against the test surface. Apply pressure to ensure that the internal sensor is completely flat against the surface of the material under test.
- The internal moisture sensor detects moisture to a depth of approximately 19 mm (0.75"). The actual depth will vary depending upon the amount of moisture, the material under test, surface roughness, and other factors.
- Pinless measurement readings are 'relative' scaled (0~100).

- The moisture reading is displayed on the main display in the upper left hand corner (thermal and camera image modes) or as large digits (Moisture-only mode). Refer to **Section 5.4 Image Modes** and **Sections 7.2 through 7.4**, for more information.
- Keep hands, surfaces, and objects away from the internal moisture sensor on the back of the MR265 when taking measurements.
- For best results, lift the meter off the surface under test between measurement points; do not drag the meter over surfaces.

### 7.6 Pin Probe Measurements

1. Select the Pin mode from the menu (*Moisture mode/Pin Mode*); see **Figure 7-9**.
2. Connect the supplied MR02 pin probe, or other external pin probe, to the meter's socket at the bottom of the meter (under the protective flap). Refer to <https://www.flir.com> for available moisture probes.
3. Select the appropriate Material Group in the menu system (*Moisture mode/Material*) as described in **Section 7.4 Moisture Measurement modes**. Also, See **Section 13 Appendices** for information on Material Groups and the associated Group numbers to choose from in the menu.
4. Press the pins into the material under test.
5. Pin-based readings are represented in %MC (moisture content) for wood and %WME (wood moisture equivalent) for materials other than wood.
6. The moisture reading is displayed on the main display (%) in the upper left hand corner (Thermal and Digital Camera images) or as large digits (Moisture-only mode). Use the menu to select the Image mode (Image mode



#### NOTE

##### Pin Probe Moisture Measurement Considerations

The MR265 will display accurate external pin probe readings in the 7% to 30% range, depending on the tested material. Moisture Content readings below 6% will display as 0% for all materials and the maximum specified range is dependent on the fibre saturation point for specific species. Above the fibre saturation point, the reading can only be used as a relative reference value.


For more information on fibre saturation please refer to public document ASTM D7438. For additional information on Pin moisture measurement accuracy please refer to public document ASTM D4444, section 6.

### 7.7 MR12 Ball Moisture Probe (Optional)

The MR12 allows you to take pinless moisture measurements with all the benefits of a remote probe, i.e. easier access to surfaces and manoeuvrability.

1. Connect the MR12 to the socket at the bottom of the meter.
2. Select the MR12 probe option in the menu (*Moisture Mode/MR12*); see **Figure 7-11**.
3. Touch the MR12 probe to the surface under test.
4. View the moisture reading on the MR265 in either the Moisture-only display mode or the Thermal/Visible camera modes. Use the menus to select the display modes (*Image Modes*).
5. Pinless measurement readings are 'relative' scaled (0~100).

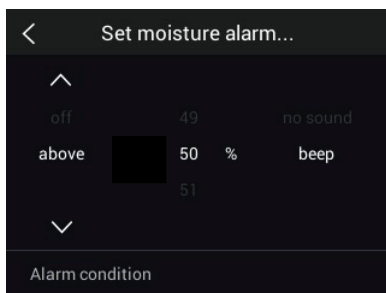
### 7.8 Set Reference Mode

1. Select the 'Set Reference' mode from the menu (*Moisture mode/Set Reference* ); see **Figure 7-12**. This mode is only available for pinless measurements, including the optional MR12 Ball Moisture probe.
2. When the 'Set Reference' mode is selected, the displays are affected in the following ways:
  - Thermal/Visible Camera modes: A delta (triangle) symbol is shown after the moisture reading indicating that the reading represents the current measurement minus the reference value (the measurement recorded at moment the 'Set Reference' mode was selected).
  - Moisture-only mode: The reference value, with delta symbol, is shown on the right side of the display and the moisture reading (offset by the reference value) is shown on the left in large digits.
3. All measurements taken subsequently will be relative to the reference value. For example, if the reference value is '20' (representing the driest area of the material under test) and a measurement of '25' is taken (in an area with higher moisture content), the measurement will show '5' ( $25 - 20 = 5$ ). As implied, this mode is useful for comparing wet areas to a dry area reference.
4. To remove the reference value and exit the mode: Remove the meter sensor from the area under test, so that the sensor is no longer touching a surface and is clear of any objects, and then select the pin-mode from the *Moisture Mode* menu.





## 7.9 High Moisture Alarm

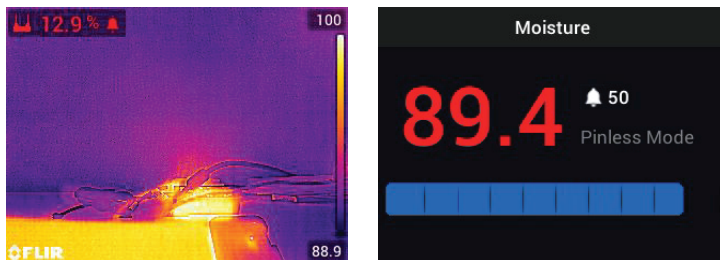
1. To access the Alarm mode use the menus (*Settings/Measurement Parameters/IR Temperature & Moisture Alarm mode*). See **Section 8.4** for High/Low IR Temperature Alarm mode.




**Figure 7.13** Setting the Moisture Alarm

2. Select the 'Set Moisture Alarm' mode.
3. Use the navigation arrows and *Select* button  to set the Alarm to 'ABOVE' or 'OFF', to set the max. threshold (0% to 100%), and to select 'No Sound' or 'Beep' for the alarm alert; the visual alert is always active. Press *Select* to confirm and press *Return*  to exit the menu.
4. When the High Alarm is enabled, the main display will show the alarm bell icon next to the measurement digits. Refer to **Section 5.8** *Settings menu* for additional information (*Settings/Measurement Parameters/IR Temperature & Moisture Alarm*).

- When the measurement exceeds the threshold, the text for the measurement reading will appear red in colour. Note that in the Moisture-only mode, the larger digits appear in red when the alarm limit is exceeded. See **Figure 7-14** below.



**Figure 7.14** Moisture Alarm display examples


- If the beeper is enabled in step 3 above, the beeper will sound when the moisture exceeds the threshold. To silence the beeper when the meter is alarming, press *Select* . The meter will open the 'Settings' menu where you can opt to turn the beeper OFF or otherwise program the alarm parameters.

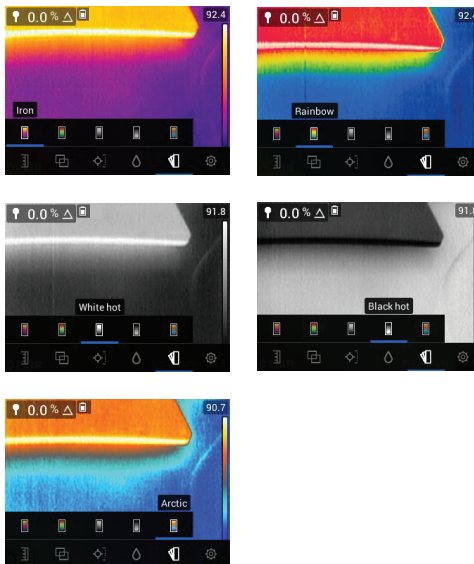
# 8 Thermal and Visible Camera Operation

## 8.1 Thermal Camera

The full screen Thermal Camera is active in the Thermal mode and the Thermal MSX® mode (digital camera image superimposed on thermal image). Select the image type in the menu: *Select button/Image Mode* as described in **Section 5.4 Image Mode Menu**.

The Thermal Camera lens is located on the back of the meter. Face the lens toward the area of interest and view the image on the MR265 display.

Select the thermal image colour palette from the menu (  *Colour*). Choose Iron, Rainbow, White hot, Black hot, or Arctic.



**Figure 8.1** Colour Palette options

On the right side of the thermal images, a vertical bar graph provides a temperature scale for convenience. The top of the scale shows the hotter pixels in the frame, and the lower part of the scale shows the colder pixels. Digital readouts appear on the top and bottom of the bar graph to show the high and low range limits for the camera image. See **Figure 8.1**.

When the Laser pointer button  $\triangle$  is pressed, the Laser beam appears. Use the Laser beam and display cross-hairs to target the surfaces under test.

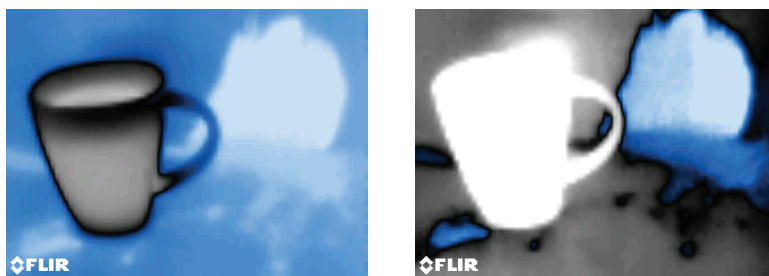
Note that the Laser is carefully aimed to align with the cross-hairs for easier identification and targeting of objects and surfaces.

Cross-hairs are visible when 'Centre Spot' is selected from the 'Measurement' menu (*Measurement mode*). Cross-hairs are also visible in the 'Custom IGM™ mode' when 'IR Temperature' is selected in the 'Custom IGM™' menu in the 'Settings' menu (*Settings/Custom IGM™*).

## 8.2 Automatic/Lock Temperature Scaling



Note: For best results, allow a warm-up period of 3-5 minutes before using this feature.

The Auto/Lock Scale option allows the colour palette range to be adjusted to suit a given application. For example, when viewing both cold and hot objects in the same frame, the auto-scaling (default mode) will cause the palette to 'stretch', as to fit the whole range of temperatures. However, this can cause smaller temperature variations to go undetected, as the difference between two colours might increase from  $1^\circ$  to  $10^\circ$ . In this case, the user may choose to lock the scale with only the cold or medium-temperature objects in the frame. This would cause the hot objects to saturate, but will provide more detail to the colder objects of interest.




**Figure 8.2** Figure on left is 'auto-scaled' while the figure on right is 'scale locked'

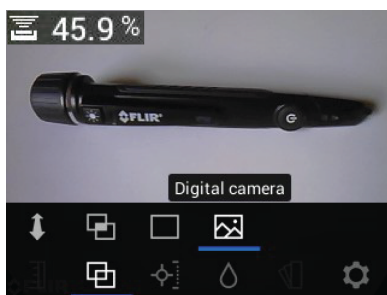
If you wish to narrow the range of colour and limit it to colours near the cold temperature image, set the scale mode to 'Lock' with no hot objects in the frame. To lock the scale, press *Select*  $\square$  to access the Main Menu, scroll to

the Temperature Scale mode , press *Select*, and scroll to the 'Lock' mode ; press *Select* to confirm and to exit the menu. Some experimentation and fine-tuning may be required to obtain the best possible contrast.

For additional programming details see **Section 5.3 Temperature Scale menu**.


### 8.3 Digital (Visible) Camera

Select the full screen Digital Camera from the menu system: *Select* button/Image Mode/Digital Camera .



**Figure 8.3** Selecting the Digital Camera image



The Digital Camera lens is located on the back of the meter. Face the lens toward the area of interest and view the image on the display.

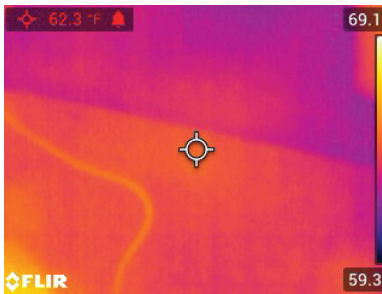
When the Laser pointer button  is pressed, the Laser beam appears. Use the Laser beam and the cross-hairs ('Centre Spot' selection in the *Measurement* menu) to target the surfaces under test. The temperature reading represents the spot targeted by the cross-hairs and Laser pointer.

Note that the Laser is carefully aimed to align with the cross-hairs for easier identification and targeting of objects and surfaces.

### 8.4 High/Low IR Temperature Alarm

1. To access the Alarm mode use the menu (*Settings/Measurement Parameters/IR Temperature & Moisture Alarm mode*).
2. Select the 'IR Temperature Alarm' mode.

3. Use the navigation arrows and *Select* button  to set the Alarm (ABOVE, BELOW, or OFF) and to set the temperature limit. There is no beeper available for the Temperature alarms so the 'No Sound' setting cannot be changed. Press *Select* to confirm and press *Return*  to exit the menu.
4. When the High or the Low Alarm is enabled, the main display will show the alarm bell icon next to the measurement digits as shown in **Figure 8-4** below.
5. When the measurement exceeds the high threshold (i.e., when ABOVE setting is chosen), the text for the measurement reading will appear red in colour. When the measurement falls below the low threshold (when BELOW setting is chosen), the text for the measurement reading will appear blue in colour.



**Figure 8.4** High Temperature Alarm example. Note that the reading is red in colour

# 9

# Capturing and Working with Images

---


## 9.1 Capturing Images





To capture a screen image, press the Camera button (shown above). The display will briefly show the filename assigned to the captured image at the top of the screen. Screen images can be captured for any Image mode: Thermal MSX®, Thermal, Digital Camera, and Moisture mode. If the internal memory is full, an error will display and images cannot be captured until room is made available in the internal storage drive. Images cannot be captured if the MR265 is connected to a device via USB.

## 9.2 Viewing Images on the MR265





Press the Image Gallery button (shown above) to open the Image Gallery. Use the navigation arrow buttons to scroll through the thumbnails and press *Select*  to open and enlarge an image. Press *Select* at an opened image to view the filename, and press again to see image options (delete, information) as explained below.

## 9.3 Deleting images

At an opened image, press *Select*  twice to see the delete and information icons. Scroll to the 'delete' icon (trash can) and press *Select*  to erase the image. Images can also be deleted in bulk by formatting the storage memory in the Settings menu (*Settings/Device Settings/Reset Options*). Images can also be deleted or moved by connecting the MR265 to a PC, see the next section.

## 9.4 Image Information

At an opened image, press *Select*  twice to see the delete and information icons. Scroll to the Information icon ('i') and press *Select*  to view the image information.

## 9.5 Transferring Images via PC Interface

Connect the MR265 to a Windows™ or Apple™ computer's USB port using the supplied USB cable. The USB socket is located on the bottom of the MR265, under the protective flap. Once connected, the MR265 can be used

as you would any external storage drive. Note that on Apple™ computers, the 'Photos' App is not compatible with the MR265 and will generate an error message (*No Photos*) when opened. However the MR265 images are recognized in the computer's Finder window.

*Note: Device is not 100% compatible with Mac OS, please do not format MR265 internal memory via Mac OS.*



# 10 Field Firmware Updates

---

The MR265 includes a USB port under the bottom flap. The USB port allows the user to update the System firmware by first downloading an update file from the FLIR website and then transferring the file to the MR265. Connect the MR265 to a PC using the supplied USB cable. Firmware updates are available from <https://support.flir.com>.

To update the firmware, you will need:

- Access to the website where the update file is located: <https://support.flir.com>
- The MR265 to be updated
- The update file. Refer to the steps in the next sections.

## 10.1 System Firmware Update

1. Visit <https://support.flir.com> to obtain a firmware update file.
2. Select the 'Downloads' tab and then select 'Instrument Firmware' (Test and Measurement) from the drop-down menu.
3. Select the MR265 from the second drop-down menu.
4. Select and download the firmware update file to the PC.
5. With the MR265 **ON** connect it to the PC via the supplied USB cable.
6. Copy the firmware update file to the MR265 root directory.
7. Eject the MR265 from the PC.
8. Disconnect the USB cable from the PC USB port and from the MR265 USB port.
9. Follow the MR265 display prompts to complete the update.

# 11 Maintenance


---

## 11.1 Cleaning

Wipe the housing with a damp cloth as needed. Do not use abrasives or solvents. Clean the lenses with a high-quality lens cleaner.

## 11.2 Battery Service

The rechargeable lithium battery is not user-serviceable. Please contact FLIR support for service instructions: <https://support.flir.com>.

If the MR265 is not going to be used for > 3 months, it should be charged to at least 70% then stored at room temperature and recharged every 6 months. Failure to do so may result in a battery that cannot be recharged and must be serviced. The battery status (as a percentage) is shown in the Settings menu, in the Meter Information sub-menu, otherwise the battery status icon on the main display can be used to approximate 70%; press *Select*  to call up the battery status icon.

## 11.3 Disposal of Electronic Waste



As with most electronic products, this equipment must be disposed of in an environmentally friendly way, and in accordance with existing regulations for electronic waste. Please contact your FLIR Systems representative for more details.

## 11.4 MR265 Crash Recovery

If the MR265 display freezes or if the MR265 in any way ceases operating normally, press and hold the up and down navigation arrow buttons for at least 10 seconds. Release the buttons when the start-up screens appear, and allow the device to reboot. No data will be lost by running this procedure. If problems persist, contact FLIR for assistance.

# 12 Specifications

## 12.1 General Specifications

Display	QVGA (320 x 240 pixel) 2.8" 64K colour TFT graphical display
Image modes	Thermal, Visual, MSX®
MSX®	Adds visual details to full resolution thermal image
Internal memory	8 G (15,000 images)
Stored image format	Radiometric JPEG
Power supply	3.7 V, 5400 mAh Li-Po battery; rechargeable via USB
Battery life	Ten (10) hours continuous run-time, maximum Typical usage: Four (4) work weeks When storing meter for > 3 months, charge battery to > 70% and recharge every 6 months
Auto Power OFF	Programmable: OFF, 5, 10, 20, and 30 minutes
Low battery indicator	Battery icon is displayed when the Main Menu is accessed. When charging, the battery status icon is displayed in the normal operating mode
Operating temperature	0 to 45°C (32 to 113°F)
Storage temperature	-20 to 60°C (-4 to 140°F)
Operating humidity	≤ 90%, 0 to 30°C (32 to 86°F)
	≤ 75%, 30 to 40°C (86 to 104°F)
	≤ 45%, 40 to 50°C (104 to 122°F)
Storage humidity	90% RH maximum
Dimensions (H x W x D)	17.7 × 8.9 × 3.6 cm (6.97 × 3.5 × 1.43 in.)
Product Weight	392 g (0.7 lbs.)
Included accessories	MR02 Standard Moisture Pin Probe, Quick Start Guide, USB Charger and Cable, and Lanyard
Language options	Multi-language support for programming menus

## 12.2 Thermal Imaging Specifications

Thermal imaging camera	FLIR Lepton®, microbolometer FPA (focal plane array)
Image calibration	Automatic (with lock-scale option: see Temperature Scale option from the Main Menu)
Thermal image resolution	160(W) x 120(H) pixels
Spectral response	8~14µm
Field of view	57° horizontal x 44° vertical
Thermal Sensitivity	< 150 mK
Object temperature range	0 to 100°C (32 to 212°F)
Detection Limit	Wet area detection @ 10 m (32'): 49 cm <sup>2</sup> (19.7 in <sup>2</sup> )
Thermal frame update rate	9 Hz
Thermal image palettes	Selectable: Iron, Rainbow, White hot, Black hot, and Arctic
Minimum focus distance	10 cm (4")
Laser pointer	Visible light Class II, centred on thermal image; 1.0 mW (max. power) Wavelength: 650 ±20nm

## 12.3 Moisture Measurement Specifications

Internal Pinless Sensor Measurements	0 to 100 (relative readings)
External Pin-based Measurements	7% to 30%; <sup>1</sup> Accuracy for 7% to 30% range: (±1.5% MC); <sup>2</sup> 30%-100% (Reference Only) <sup>3</sup>
Measurement Resolution	0.1
Pinless Measurement Depth	1.9 cm (0.75 in.) maximum
Pin Moisture Groups	Eleven (11) material groups
Response time	Pinless mode: 100 ms, Pin mode: 750 ms

1. Maximum specified range is dependent on the fibre saturation point for specific species. Beyond this point, the reading can only be used as a relative reference value. For more information on fibre saturation please refer to public document ASTM D7438. Accuracy specification is based on the analysis in J. Fernández-Golfín et al. Actual real-world accuracy depends on a variety of factors; For more information, refer to public document ASTM D4444, section 6.
2. Accuracy spec. applies to pin probe moisture measurements taken on wood whose temperature is 20 °C (70 °F). Add 0.1% to the accuracy spec. for each °C below 20 or subtract 0.1 for each °C above 20.

3. See Note 1.

### 12.4 Visible Spectrum Camera Specifications

Camera resolution	2M pixels
Focus	Fixed
Field of view	83° (70.5° Horizontal x 56° Vertical)

### 12.5 Safety Specifications


General Safety	CE/EN/UL/CSA/PSE 61010
Environmental Safety	REACH Regulation EC 1907/2006 RoHS2 Directive 2011/65/EC WEEE Directive 2012/19/EC JIS C 6802:2011 laser directive IEC 60825-1 class II laser directive FDA Laser directive
Encapsulation	IP54 (IEC 60529) with bottom flap fully sealed
Energy Certification	CEC (BC), DOE and NRCAN
Drop-proof	Designed to 2 m (6.6 ft.)
EMC	EN 61000-6-3 EN 61000-6-2 FCC 47 CFR Part 15 Class B

# 13 Appendices

## 13.1 Material Groups

### 13.1.1 Common names of timbers

(BS888/589:1973) with MR265 Group Numbers

	<b>NOTE</b>
<p>Use Group 9 for building materials: plywood, drywall, and oriented strand board (OSB).            Use Group 10 for brick, cement screed, and concrete.            Use Group 11 for cement mortar, anhydrite screed, lime mortar, and plaster.            Groups 10 and 11 are not specified for accuracy and should be used for reference (comparative purposes) only.</p>	

Material	Group	Material	Group	Material	Group
Abura	4	Gurjun	1	Pine, American Long Leaf	3
Afara	1	Hemlock, Western	3	Pine, American Pitch	3
Aformosa	6	Hiba	8	Pine, Bunya	2
Afzelia	4	Hickory	5	Pine, Caribbean Pitch	3
Agba	8	Hyedunani	2	Pine, Corsican	3
Amboyna	6	Iroko	5	Pine, Hoop	3
Ash, American	2	Ironbank	2	Pine, Huon	2
Ash, European	1	Jarrah	3	Pine, Japanese Black	2
Ash, Japanese	1	Jelutong	3	Pine, Kauri	4
Ayan	3	Kapur	1	Pine, Lodgepole	1
Baguacu, Brazilian	5	Karri	1	Pine, Maritime	2
Balsa	1	Kauri, New Zealand	4	Pine, New Zealand White	2
Banga Wangra	1	Kauri, Queensland	8	Pine, Nicaraguan Pitch	3
Basswood	6	Keruing	5	Pine, Parana	2

Beech, European	3	Kuroka	1	Pine, Ponderosa	3
Berlina	2	Larch, European	3	Pine, Radiata	3
Binvang	4	Larch, Japanese	3	Pine, Red	2
Birch, European	8	Larch, Western	5	Pine, Scots	1
Birch, Yellow	1	Lime	4	Pine, Sugar	3
Bisselon	4	Loliondo	3	Pine, Yellow	1
Bitterwood	5	Mahogany, African	8	Poplar, Black	1
Blackbutt	3	Mahogany, West Indian	2	Pterygota, African	1
Bosquiea	1	Makore	2	Pyinkado	4
Boxwood, Maracaibo	1	Mansonia	2	Queensland Kauri	8
Camphorwood, E African	3	Maple, Pacific	1	Queensland Walnut	3
Canarium, African	2	Maple, Queensland	2	Ramin	6
Cedar, Japanese	2	Maple, Rock	1	Redwood, Baltic (European)	1
Cedar, West Indian	8	Maple, Sugar	1	Redwood, Californian	2
Cedar, Western Red	3	Matai	4	Rosewood, Indian	1
Cherry, European	8	Meranti, Red (dark/light)	2	Rubberwood	7
Chestnut	3	Meranti, White	2	Santa Maria	7
Coachwood	6	Merbau	2	Sapele	3
Cordia, American Light	5	Missanda	3	Sen	1
Cypress, E African	1	Muhuhi	8	Seraya, Red	3

Cypress, Japanese (18-28% mc)	3	Muninga	6	Silky Oak, African	3
Cypress, Japanese (8-18%mc)	8	Musine	8	Silky Oak, Australian	3
Dahoma	1	Musizi	8	Spruce, Japanese (18-28% mc)	3
Danta	3	Myrtle, Tasmanian	1	Spruce, Japanese (8-18% mc)	8
Douglas Fir	2	Naingon	3	Spruce, Norway (European)	3
Elm, English	4	Oak, American Red	1	Spruce, Sitka	3
Elm, Japanese Grey Bark	2	Oak, American White	1	Sterculia, Brown	1
Elm, Rock	4	Oak, European	1	Stringybark, Messmate	3
Elm, White	4	Oak, Japanese	1	Stringybark, Yellow	3
Empress Tree	8	Oak, Tasmanian	3	Sycamore	5
Erimado	5	Oak, Turkey	4	Tallowwood	1
Fir, Douglas	2	Obeche	6	Teak	5
Fir, Grand	1	Odoko	4	Totara	4
Fir, Noble	8	Okwen	2	Turpentine	3
Gegu, Nohor	7	Olive, E African	2	Utile	8
Greenheart	3	Olivillo	6	Walnut, African	8
Guarea, Black	8	Opepe	7	Walnut, American	1
Guarea, White	7	Padang	1	Walnut, European	3
Gum, American Red	1	Padauk, African	5	Walnut, New Guinea	2



Gum, Saligna	2	Panga Panga	1	Walnut, Queensland	3
Gum, Southern	2	Persimmon	6	Wandoo	8
Gum, Spotted	1	Pillarwood	5	Wawa	6
				Whitewood	3
				Yew	3

### 13.1.2 Botanical names of timbers

Material	Group	Material	Group	Material	Group
Abies alba	1	Eucalyptus acmenicides	3	Picea jezoensis (8-18%mc)	8
Abies grandis	1	Eucalyptus crebra	2	Picea sitchensis	3
Abies procera	8	Eucalyptus diversicolour	1	Pinus caribaea	3
Acanthopanax ricinifolius	1	Eucalyptus globulus	2	Pinus contorta	1
Acer macrophyllum	1	Eucalyptus maculate	1	Pinus lampertiana	3
Acer pseudoplatanus	5	Eucalyptus marginata	3	Pinus nigra	3
Acer saccharum	1	Eucalyptus microcorys	1	Pinus palustris	3
Aetoxicon punctatum	6	Eucalyptus obliqua	3	Pinus pinaster	2
Aformosia elata	6	Eucalyptus pilularis	3	Pinus ponderosa	3
Afzelia spp	4	Eucalyptus saligna	2	Pinus radiata	3
Agathis australis	4	Eucalyptus wandoo	8	Pinus spp	2
Agathis palmerstoni	8	Fagus sylvatica	3	Pinus strobus	1
Agathis robusta	8	Flindersia brayleyana	2	Pinus sylvestris	1

Amblygonocarpus andogensis	1	Fraxinus Americana	2	Pinus thunbergii	2
Amblygonocarpus obtusungulis	1	Fraxinus excelsior	1	Pipadeniastrum africanum	1
Araucaria angustifolia	2	Fraxinus japonicus	1	Piptadenia africana	1
Araucaria bidwilli	2	Fraxinus mardshurica	1	Podocarpus dactyloides	2
Araucaria cunninghamii	3	Gonystylus macrophyllum	6	Podocarpus spicatus	3
Berlinia grandiflora	2	Gossweilodendron balsamiferum	8	Podocarpus totara	4
Berlinia spp	2	Gossypiospermum proerox	1	Populus spp	1
Betula alba	8	Grevillea robusta	3	Prunus avium	8
Betula alleghaniensis	8	Guarea cedrata	7	Pseudotsuga menzesii	2
Betula pendula	8	Guarea thomsonii	8	Pterocarpus angolensis	6
Betula spp	8	Guibortia ehie	2	Pterocarpus indicus	6
Bosquiera phoberos	1	Hevea brasiliensis	7	Pterocarpus soyauxii	5
Brachylaena hutchinsii	8	Intsia bijuga	2	Pterygota bequaertii	1
Brachystegia spp	2	Juglans nigra	1	Quercus cerris	4
Calophyllum brasiliense	7	Juglans regia	3	Quercus delegatensis	3
Canarium schweinfurthii	2	Khaya ivorensis	8	Quercus gigantean	3
Cardwellia sublimes	3	Khaya senegalensis	4	Quercus robur	1
Carya glabra	5	Larix decidua	3	Quercus spp	1

Cassipourea elliotii	5	Larix kaempferi	3	Ricinodendron heudelotti	5
Cassipourea melanosana	5	Larix leptolepis	3	Sarcocephalus diderrichii	7
Castanea sativa	3	Larix occidentalis	5	Scottellia coriacea	4
Cedrela odorata	8	Liquidambar styraciflua	1	Sequoia sempervirens	2
Ceratopetalum apetalum	6	Lovoa klaineana	8	Shorea spp	2
Chamaecyparis spp (18-28%mc)	3	Lovoa trichiloides	8	Sterculia rhinopetala	1
Chamaecyparis spp (8-18%mc)	8	Maesopsis eminii	8	Swietenia candollei	1
Chlorophora excelsa	5	Mansonia altissima	2	Swietenia mahogani	2
Cordia alliodora	5	Millettia stuhimannii	1	Syncarpia glomulifera	3
Croton megalocarpus	8	Mimusops heckelii	2	Syncarpia laurifolia	3
Cryptomelia japonica	2	Mitragyna ciliata	4	Tarrietia utilis	3
Cupressus spp	1	Nauclea diderrichii	7	Taxus baccata	3
Dacrydium franklinii	2	Nesogordonia papaverifera	3	Tectona grandis	5
Dalbergia latifolia	1	Nothofagus cunninghamii	1	Terminalia superba	1
Diospyros virginiana	6	Ochroma pyramidalis	1	Thuja plicata	3
Dipterocarpus (Keruing)	5	Ocotea rodiaei	3	Thujopsis dolabrata	8
Dipterocarpus zeylanicus	1	Ocotea usambarensis	3	Tieghamella heckelii	2
Distemonanthus benthamianus	3	Octomeles sumatrana	4	Tilia americana	6

Dracontomelium mangiferum	2	Olea hochstetteri	2	Tilia vulgaris	4
Dryobalanops spp	1	Olea welwitschii	3	Triploehiton scleroxylon	6
Dyera costulata	3	Palaquium spp	1	Tsuga heterophylla	3
Endiandra palmerstoni	3	Paulownia tomentosa	8	Ulmus americana	4
Entandrophragma angolense	7	Pericopsis elata	6	Ulmus procera	4
Entandrophragma cylindricum	3	Picaenia excelsa	3	Ulmus thomasi	4
Entandrophragma utile	8	Picea abies	3	Xylia dolabriformis	4
Erythrophleum spp	3	Picea jezoensis (18-28%mc)	3	Zelkova serrata	2

### 13.2 %WME Table (% Wood Moisture Equivalent)

Material Wood Group Nos.								
1	2	3	4	5	6	7	8	9
%WME (percent wood moisture equivalent)								
7	8.2	9	8	7.1	7	11	10.5	-
8	10	10.5	9.3	7.5	7.4	11.5	11	-
9	10.8	10.9	9.7	7.9	8.1	12.1	11.6	8.5
10	11.7	11.5	10.4	8.6	8.8	12.7	12.2	9.4
11	12.7	12.6	11.3	9.5	9.7	13.4	13.4	10.5
12	13.6	13.7	12.1	10.5	10.5	14	14.3	11.5
13	14.5	14.5	12.7	11.2	11.2	14.5	15.1	12.5
14	15.3	15.5	13.4	11.8	11.8	15	16	13.5
15	16.3	16.7	14.1	12.5	12.6	15.6	17	14.4
16	16.9	17.5	14.8	13	13.2	16	17.7	14.9
17	17.7	18.8	15.7	14.3	13.9	16.6	18.5	15.3
18	18.2	19.7	16.3	15	14.5	17	19.1	16.1
19	19	21	16.9	15.9	15.2	17.6	20	16.7
20	20	22.6	17.8	16.9	16.1	18.4	21.3	17.2

---

21	20.8	23.5	18.5	17.6	16.8	19.1	22.3	18.3
22	21.5	24.5	19.3	18.3	17.4	19.7	23.2	19.1
23	22.9	26.4	20.2	19.8	18.6	21.2	25.3	19.9
24	23.5	27.4	20.8	20.4	19	22	25.8	20.5
25	24.2	27.8	21.2	21	19.4	22.7	26.3	≈23
26	25.3	29	22.4	22.3	20.1	23.9	27.3	-
27	26.5	-	23.3	23.4	20.8	24.7	28.1	-
28	28	-	24.4	24.8	21.7	25.9	-	-
29	29.6	-	25.6	26.3	22.9	27.1	-	-

# 14 Limited 10–Year Warranty

---

This product is protected by FLIR's Limited 10-Year Warranty.

Visit [www.flir.com/testwarranty](http://www.flir.com/testwarranty) to read the Limited 10-Year Warranty document.

# 15 Customer Support

---

Repair, Calibration, and Technical Support: <https://support.flir.com>.

Customer Support Telephone List: <https://support.flir.com/contact>









---

**Website**

<http://www.flir.com>

**Customer support**

<http://support.flir.com>

**Copyright**

© 2021, FLIR Systems, Inc. All rights reserved worldwide.

**Disclaimer**

Specifications subject to change without further notice. Models and accessories subject to regional market considerations. License procedures may apply. Products described herein may be subject to US Export Regulations. Please refer to [exportquestions@flir.com](mailto:exportquestions@flir.com) with any questions.

Publ. No.: NAS100070  
Release: AB  
Commit: 77165  
Head: 77326  
Language: en-GB  
Modified: 2021-06-03  
Formatted: 2021-06-14