

# BK PRECISION®

4050B Series

## Function/Arbitrary Waveform Generator

USER MANUAL



## Safety Summary

The following safety precautions apply to both operating and maintenance personnel and must be followed during all phases of operation, service, and repair of this instrument.

### **WARNING**

Before applying power to this instrument:

- Read and understand the safety and operational information in this manual.
- Apply all the listed safety precautions.
- Verify that the voltage selector at the line power cord input is set to the correct line voltage. Operating the instrument at an incorrect line voltage will void the warranty.
- Make all connections to the instrument before applying power.
- Do not operate the instrument in ways not specified by this manual or by B&K Precision.

Failure to comply with these precautions or with warnings elsewhere in this manual violates the safety standards of design, manufacture, and intended use of the instrument. B&K Precision assumes no liability for a customer's failure to comply with these requirements.

### ***Category rating***

The IEC 61010 standard defines safety category ratings that specify the amount of electrical energy available and the voltage impulses that may occur on electrical conductors associated with these category ratings. The category rating is a Roman numeral of I, II, III, or IV. This rating is also accompanied by a maximum voltage of the circuit to be tested, which defines the voltage impulses expected and required insulation clearances. These categories are:

**Category I (CAT I):** Measurement instruments whose measurement inputs are not intended to be connected to the mains supply. The voltages in the environment are typically derived from a limited-energy transformer or a battery.

**Category II (CAT II):** Measurement instruments whose measurement inputs are meant to be connected to the mains supply at a standard wall outlet or similar sources. Example measurement environments are portable tools and household appliances.

**Category III (CAT III):** Measurement instruments whose measurement inputs are meant to be connected to the mains installation of a building. Examples are measurements inside a building's circuit breaker panel or the wiring of permanently-installed motors.

Category IV (CAT IV): Measurement instruments whose measurement inputs are meant to be connected to the primary power entering a building or other outdoor wiring.

**⚠ WARNING**

Do not use this instrument in an electrical environment with a higher category rating than what is specified in this manual for this instrument.

**⚠ WARNING**

You must ensure that each accessory you use with this instrument has a category rating equal to or higher than the instrument's category rating to maintain the instrument's category rating. Failure to do so will lower the category rating of the measuring system.

***Electrical Power***

This instrument is intended to be powered from a CATEGORY II mains power environment. The mains power should be 120 V RMS or 240 V RMS. Use only the power cord supplied with the instrument and ensure it is appropriate for your country of use.

***Ground the Instrument***

**⚠ WARNING**

To minimize shock hazard, the instrument chassis and cabinet must be connected to an electrical safety ground. This instrument is grounded through the ground conductor of the supplied, three-conductor AC line power cable. The power cable must be plugged into an approved three-conductor electrical outlet. The power jack and mating plug of the power cable meet IEC safety standards.

**⚠ WARNING**

Do not alter or defeat the ground connection. Without the safety ground connection, all accessible conductive parts (including control knobs) may provide an electric shock. Failure to use a properly-grounded approved outlet and the recommended three-conductor AC line power cable may result in injury or death.

## **WARNING**

Unless otherwise stated, a ground connection on the instrument's front or rear panel is for a reference of potential only and is not to be used as a safety ground.

***Do not operate in an explosive or flammable atmosphere***

## **WARNING**

Do not operate the instrument in the presence of flammable gases or vapors, fumes, or finely-divided particulates.

## **WARNING**

The instrument is designed to be used in office-type indoor environments. Do not operate the instrument

- In the presence of noxious, corrosive, or flammable fumes, gases, vapors, chemicals, or finely-divided particulates.
- In relative humidity conditions outside the instrument's specifications.
- In environments where there is a danger of any liquid being spilled on the instrument or where any liquid can condense on the instrument.
- In air temperatures exceeding the specified operating temperatures.
- In atmospheric pressures outside the specified altitude limits or where the surrounding gas is not air.
- In environments with restricted cooling air flow, even if the air temperatures are within specifications.
- In direct sunlight.

## **CAUTION**

This instrument is intended to be used in an indoor pollution degree 2 environment. The operating temperature range is 0 °C to 40 °C and the operating humidity is ≤ 90 % relative humidity at < 35 °C and ≤ 60 % relative humidity at 35 °C – 40 °C, with no condensation allowed.



Measurements made by this instrument may be outside specifications if the instrument is used in non-office-type environments. Such environments may include rapid temperature or humidity changes, sunlight, vibration and/or mechanical shocks, acoustic noise, electrical noise, strong electric fields, or strong magnetic fields.

***Do not operate instrument if damaged***



If the instrument is damaged, appears to be damaged, or if any liquid, chemical, or other material gets on or inside the instrument, remove the instrument's power cord, remove the instrument from service, label it as not to be operated, and return the instrument to B&K Precision for repair. Notify B&K Precision of the nature of any contamination of the instrument.

***Clean the instrument only as instructed***



Do not clean the instrument, its switches, or its terminals with contact cleaners, abrasives, lubricants, solvents, acids/bases, or other such chemicals. Clean the instrument only with a clean dry lint-free cloth or as instructed in this manual.

***Not for critical applications***



This instrument is not authorized for use in contact with the human body or for use as a component in a life-support device or system.

***Do not touch live circuits***

**⚠ WARNING**

Instrument covers must not be removed by operating personnel. Component replacement and internal adjustments must be made by qualified service-trained maintenance personnel who are aware of the hazards involved when the instrument's covers and shields are removed. Under certain conditions, even with the power cord removed, dangerous voltages may exist when the covers are removed. To avoid injuries, always disconnect the power cord from the instrument, disconnect all other connections (for example, test leads, computer interface cables, etc.), discharge all circuits, and verify there are no hazardous voltages present on any conductors by measurements with a properly-operating voltage-sensing device before touching any internal parts. Verify the voltage-sensing device is working properly before and after making the measurements by testing with known-operating voltage sources and test for both DC and AC voltages. Do not attempt any service or adjustment unless another person capable of rendering first aid and resuscitation is present.

Do not insert any object into an instrument's ventilation openings or other openings.

**⚠ WARNING**

Hazardous voltages may be present in unexpected locations in circuitry being tested when a fault condition in the circuit exists.

***Servicing***

**⚠ CAUTION**

Do not substitute parts that are not approved by B&K Precision or modify this instrument. Return the instrument to B&K Precision for service and repair to ensure that safety and performance features are maintained.

## *Cooling fans*

### **CAUTION**

This instrument contains one or more cooling fans. For continued safe operation of the instrument, the air inlet and exhaust openings for these fans must not be blocked nor must accumulated dust or other debris be allowed to reduce air flow. Maintain at least 25 mm clearance around the sides of the instrument that contain air inlet and exhaust ports. If mounted in a rack, position power devices in the rack above the instrument to minimize instrument heating while rack mounted. Do not continue to operate the instrument if you cannot verify the fan is operating (note some fans may have intermittent duty cycles). Do not insert any object into the fan's inlet or outlet.

#### *For continued safe use of the instrument*

- Do not place heavy objects on the instrument.
- Do not obstruct cooling air flow to the instrument.
- Do not place a hot soldering iron on the instrument.
- Do not pull the instrument with the power cord, connected probe, or connected test lead.
- Do not move the instrument when a probe is connected to a circuit being tested.

## Compliance Statements

Disposal of Old Electrical & Electronic Equipment (Applicable in the European Union and other European countries with separate collection systems)

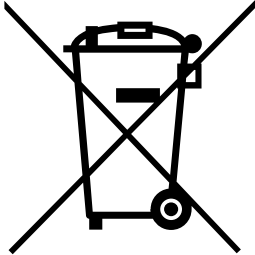

This product is subject to Directive 2002/96/EC of the European Parliament and the Council of the European Union on waste electrical and electronic equipment (WEEE), and in jurisdictions adopting that Directive, is marked as being put on the market after August 13, 2005, and should not be disposed of as unsorted municipal waste. Please utilize your local WEEE collection facilities in the disposition of this product and otherwise observe all applicable requirements.

# CE Declaration of Conformity

This instrument meets the requirements of 2006/95/EC Low Voltage Directive and 2004/108/EC Electromagnetic Compatibility Directive with the following standards.











## Low Voltage Directive

- EN61010-1: 2001

## EMC Directive

- EN 61000-3-2: 2006
- EN 61000-3-3: 1995+A1: 2001+A2: 2005
- EN 61000-4-2 / -3 / -4 / -5 / -6 / -11
- EN 61326-1: 2006

## Safety Symbols

	Refer to the user manual for warning information to avoid hazard or personal injury and prevent damage to instrument.
	Electric Shock hazard
	Alternating current (AC)
	Chassis (earth ground) symbol.
	Ground terminal
	On (Power). This is the In position of the power switch when instrument is ON.
	Off (Power). This is the Out position of the power switch when instrument is OFF.
	Power Switch (On/Off). This is the power switch located in front of the instrument.
	CAUTION indicates a hazardous situation which, if not avoided, will result in minor or moderate injury.
	WARNING indicates a hazardous situation which, if not avoided, could result in death or serious injury.
	DANGER indicates a hazardous situation which, if not avoided, will result in death or serious injury.

## Notations

**TEXT** – Denotes a softkey.

**TEXT** – Denotes a front panel button.

[TEXT] – Denotes a physical connector in the front or rear panel.

# Table of Contents

<b>SAFETY SUMMARY</b> .....	<b>I</b>
COMPLIANCE STATEMENTS .....	VII
SAFETY SYMBOLS .....	IX
NOTATIONS .....	IX
<b>1 GENERAL INFORMATION</b> .....	<b>1</b>
1.1 PRODUCT OVERVIEW .....	1
1.2 PACKAGE CONTENTS .....	1
1.3 FRONT PANEL OVERVIEW .....	3
<i>Front Panel Description</i> .....	3
1.4 REAR PANEL OVERVIEW .....	4
<i>Rear Panel Description</i> .....	4
1.5 DISPLAY OVERVIEW .....	5
<i>Display Description</i> .....	5
<b>2 GETTING STARTED</b> .....	<b>6</b>
2.1 INPUT POWER REQUIREMENTS .....	6
<i>Input Power</i> .....	6
2.2 OUTPUT CONNECTIONS .....	6
<i>Impedance Matching</i> .....	7
2.3 PRELIMINARY CHECK.....	7
<i>Check Model and Firmware Version</i> .....	8
<i>Output Check</i> .....	9
<b>3 FRONT PANEL OPERATION</b> .....	<b>11</b>
3.1 MENU OPTIONS.....	11
3.2 SELECTING A CHANNEL .....	14
3.3 CONFIGURE WAVEFORM OUTPUT .....	15
<i>Configure Waveform Shape</i> .....	15
<i>Configure Frequency</i> .....	17
<i>Configure Amplitude</i> .....	18
User-Defined High and Low Level .....	19
<i>Configure Offset</i> .....	19
<i>Configure Phase</i> .....	20
<i>Configure Duty Cycle: Square Waveform</i> .....	21
<i>Configure Width and Duty Cycle: Pulse Waveform</i> .....	22
<i>Configure Rise/Fall Edge: Pulse Waveform</i> .....	23
<i>Configure Delay: Pulse Waveform</i> .....	24
<i>Configure Symmetry: Ramp Waveform</i> .....	25
<i>Configure Standard Deviation and Mean: Noise Waveform</i> .....	26
<i>Configure Offset: DC Waveform</i> .....	27
<i>Configure Arbitrary Waveforms</i> .....	28
Generate Predefined Built-in Waveforms.....	28
Generate User-Defined Waveforms.....	36
<i>Configure Harmonic Generator</i> .....	38
3.4 CONFIGURE MODULATION OUTPUT .....	40
<i>AM Modulation</i> .....	41

	Selecting Modulation Source .....	43
	To Set Modulation Depth .....	44
	To Set Modulation Frequency .....	44
	<i>DSB-AM Modulation</i> .....	44
	<i>FM Modulation</i> .....	46
	To Set Frequency Deviation .....	47
	<i>PM (Phase Modulation)</i> .....	47
	To Set Phase Deviation .....	48
	<i>FSK Modulation</i> .....	48
	To Set Key Frequency .....	49
	To Set Hop Frequency .....	50
	<i>ASK Modulation</i> .....	50
	<i>PSK Modulation</i> .....	51
	<i>PWM (Pulse Width Modulation)</i> .....	52
	To Set Pulse Width/Duty Deviation .....	53
3.5	CONFIGURE SWEEP OUTPUT .....	55
	<i>Sweep time</i> .....	56
	<i>Sweep Frequency</i> .....	56
	<i>Sweep Trigger Source</i> .....	56
	<i>Trig out</i> .....	57
	<i>Sweep Type</i> .....	58
	<i>Direction</i> .....	59
3.6	CONFIGURE BURST .....	59
	<i>N-Cycle</i> .....	60
	Cycles .....	61
	Infinite .....	61
	<i>Gated</i> .....	62
	<i>Common Settings for NCycle and Gated Burst:</i> .....	63
	Start Phase .....	63
	Burst Period .....	63
	Trig Delay .....	63
	Burst Trigger Source .....	64
<b>4</b>	<b>UTILITY FUNCTIONS</b> .....	<b>65</b>
4.1	SYSTEM SETTINGS .....	66
	<i>Numerical Format</i> .....	67
	<i>Language Setup</i> .....	68
	<i>Power On</i> .....	68
	<i>Set to Default</i> .....	69
	<i>Key Sound (Beeper)</i> .....	70
	<i>Screen Saver</i> .....	70
	<i>System Info</i> .....	70
	<i>Firmware Update</i> .....	71
	<i>Built-in Help</i> .....	72
4.2	TEST/CAL .....	73
	<i>ScrTest</i> .....	73
	<i>Key Test</i> .....	74
	<i>LED Test</i> .....	74
	<i>Board Test</i> .....	75
4.3	FREQUENCY COUNTER .....	75



4.4	OUTPUT .....	77
	<i>Load</i> .....	78
	<i>Polarity</i> .....	78
	<i>EqPhase</i> .....	79
	<i>Combining Waveforms (Wave Combine)</i> .....	79
4.5	CH COPY/COUPLING .....	80
	<i>Channel Copy</i> .....	80
	<i>Channel Coupling</i> .....	81
	Frequency Coupling .....	82
	Amplitude Coupling .....	82
	Phase Coupling .....	83
	<i>Tracking</i> .....	83
4.6	REMOTE INTERFACE .....	85
	<i>USB Interface</i> .....	86
	<i>GPIO Interface</i> .....	86
	<i>LAN</i> .....	88
	To Set IP Address .....	88
	To Set Subnet Mask .....	89
	To Set Gateway .....	89
	DHCP Configuration Mode .....	89
4.7	SYNC OUTPUT .....	90
	<i>Syncing Signals of Different Waveforms</i> .....	91
	Basic Waveform and Arbitrary Waveform .....	91
	Modulated Waveform .....	91
4.8	REFERENCE CLOCK .....	91
	<i>Sync methods for two or more instruments:</i> .....	92
	Synchronization between two instruments .....	92
	Synchronization among multiple instruments .....	92
4.9	MODE .....	92
4.10	OVER VOLTAGE PROTECTION .....	94
<b>5</b>	<b>STORE AND RECALL .....</b>	<b>95</b>
5.1	STORAGE SYSTEM .....	96
	<i>Local (C:)</i> .....	96
	<i>USB Device (0:)</i> .....	96
	<i>Browse</i> .....	97
5.2	FILE TYPE .....	97
5.3	SAVE THE INSTRUMENT STATE .....	98
5.4	RECALL STATE FILE OR DATA FILE .....	100
5.5	DELETE FILE .....	100
5.6	COPY AND PASTE FILE .....	100
<b>6</b>	<b>EXAMPLES .....</b>	<b>102</b>
	<i>Example 1: Generate a Sine Waveform</i> .....	103
	<i>Example 2: Generate a Square Waveform</i> .....	104
	<i>Example 3: Generate a Ramp Waveform</i> .....	105
	<i>Example 4: Generate a Pulse Waveform</i> .....	106
	<i>Example 5: Generate a Noise</i> .....	107
	<i>Example 6: Generate a DC Waveform</i> .....	108
	<i>Example 7: Generate a Linear Sweep Waveform</i> .....	109

	<i>Example 8: Generate a Burst Waveform .....</i>	<i>110</i>
	<i>Example 9: Generate an AM Modulation Waveform .....</i>	<i>112</i>
	<i>Example 10: Generate an FM Modulation Waveform .....</i>	<i>113</i>
	<i>Example 11: Generate a PM Modulated Waveform .....</i>	<i>114</i>
	<i>Example 12: Generate an FSK Modulated Waveform .....</i>	<i>115</i>
	<i>Example 13: Generate an ASK Modulation Waveform.....</i>	<i>116</i>
	<i>Example 14: Generate a PSK Modulated Waveform .....</i>	<i>117</i>
	<i>Example 15: Generate a PWM Modulated Waveform.....</i>	<i>118</i>
	<i>Example 16: Generate a DSB-AM Modulated Waveform.....</i>	<i>119</i>
<b>7</b>	<b>TROUBLESHOOTING GUIDE .....</b>	<b>120</b>
<b>8</b>	<b>SPECIFICATIONS .....</b>	<b>121</b>
	<b>SERVICE INFORMATION .....</b>	<b>125</b>
	<b>LIMITED THREE-YEAR WARRANTY .....</b>	<b>126</b>

# 1 General Information

## 1.1 Product Overview

BK Precision's 4050B series are dual-channel function/arbitrary waveform generators, capable of generating sine and square waves of up to 10 MHz, 30 MHz or 60 MHz (depending on model). They have an informative easy-to-read color display, user-friendly controls and a numeric keypad which allows users to easily configure waveform properties. These waveform generators can output square waves with frequencies up to 60 MHz (depending on model) and less than 300 ps + 0.05 ppm of period of jitter. In addition, they feature non-volatile built-in memory to create, store, and recall arbitrary waveforms up to 16K points with a 150 MSa/s sampling rate, and 14-bit vertical resolution. 196 predefined arbitrary waveforms are also available for output. Having USBTMC, LAN, and GPIB (optional adapter) interfaces, these generators allow users to easily interface with application software to create and load arbitrary waveforms into the instrument.

### Features:

- Dual-channel output with bandwidth up to 10 MHz, 30 MHz or 60 MHz
- Amplitude up to 10 Vpp into 50 ohms.
- 150 MSa/s sampling rate, 14-bit vertical resolution, and 16K points waveform length
- Capable of generating low jitter pulse waveforms
- Square waves with low jitter and frequencies up to 60 MHz (depending on model)
- AM, DSB-AM, FM, PM, FSK, ASK, PSK and PWM modulation functions
- Sweep and burst functions
- Harmonic waveforms generator
- Waveform combining function
- High-precision frequency counter
- 196 built-in arbitrary waveforms
- 4.3" TFT-LCD display, 480 x 272 resolution

## 1.2 Package Contents

Please inspect the instrument mechanically and electrically upon receiving it. Unpack all items from the shipping carton, and check for any obvious signs of physical damage that may have occurred during transportation. Report any damage to the shipping agent immediately. Save the original packing carton for possible future reshipment. Every instrument is shipped with the following contents:

- **1 x 4050B series function/arbitrary waveform generator**
- **1 x Getting started manual (printed)**
- **1 x AC power cord**
- **1 x USB type A to Type B cable**
- **1 x Certificate of calibration**

Verify that all items above are included in the shipping container. If anything is missing, please contact B&K Precision.

An optional USB to GPIB adapter model AK40G is also available.

### 1.3 Front Panel Overview

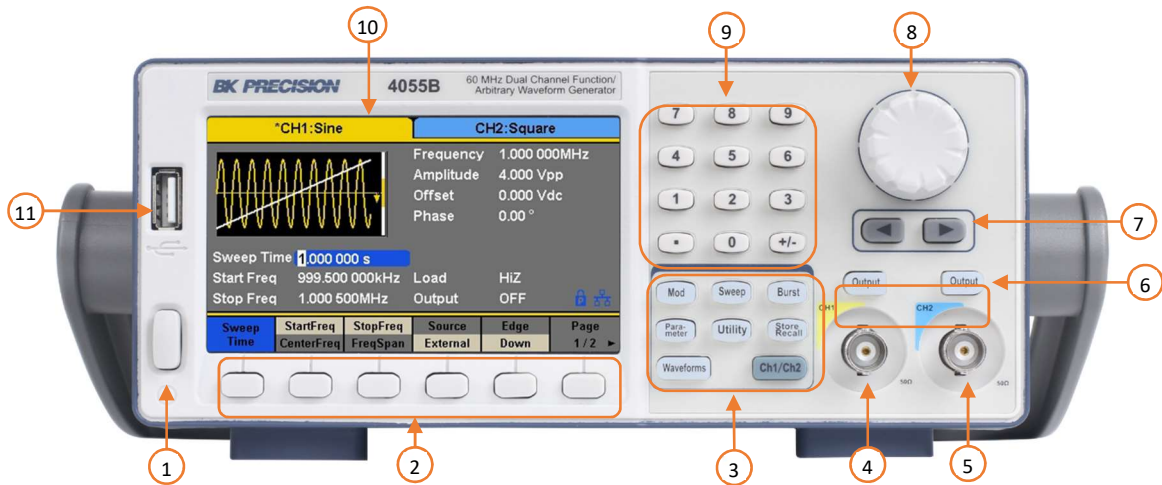

#### Front Panel Description

① Power On/Off switch

② Menu softkeys

③ Menu buttons

④ Channel 1 output terminal

⑤ Channel 2 output terminal

⑥ Channel 1 and 2 Output On/Off buttons

⑦ Arrow keys

⑧ Rotary dial knob

⑨ Numeric keypad

⑩ TFT LCD color display

#### USB host port/\*USB-to-GPIB adapter interface

⑪ Accepts USB flash drive to save/recall instrument settings and waveforms.  
 \*This port can be used for connecting the USB-to-GPIB adapter (AK40G) accessory. It can also be used for connecting an external USB flash drive.

## 1.4 Rear Panel Overview

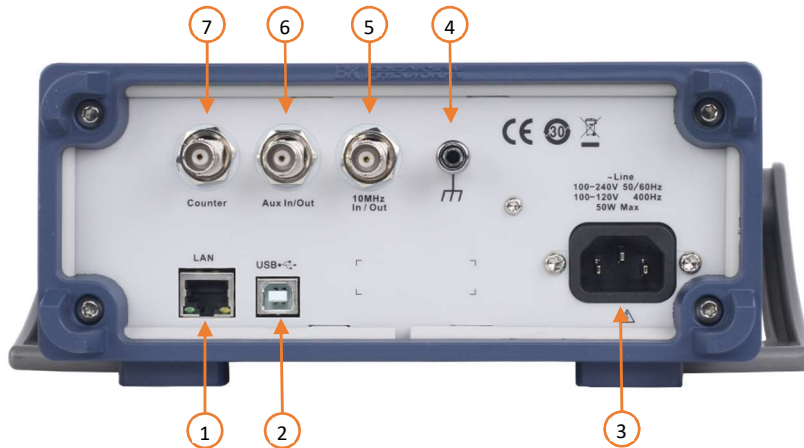

### ***Rear Panel Description***

---

① LAN Interface

---

② USB interface

---

③ AC Power Input

---

④ Chassis ground

---

⑤ 10MHz Out BNC connector

---

⑥ Aux In/Out BNC connector

---

⑦ Counter BNC Connector

---

## 1.5 Display Overview

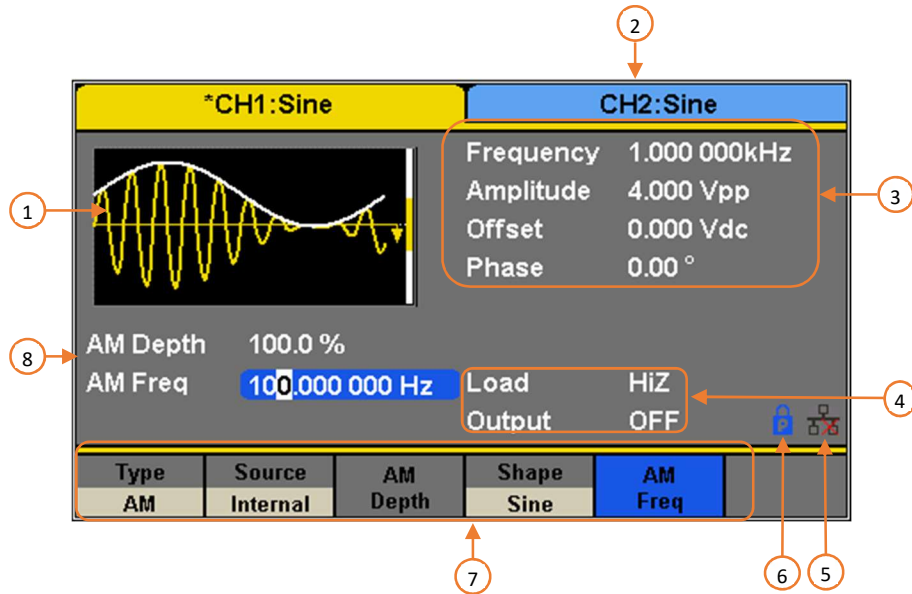

### Display Description

①	Waveform display
②	Channel status bar
③	Waveform parameters display
④	Waveform mode and output impedance indicator
⑤	LAN status indicator
⑥	Mode phase locked/free running indicator
⑦	Menu display
⑧	Waveform parameters display

## 2 Getting Started

Before connecting and powering up the instrument, please review and go through the instructions in this chapter.

### 2.1 Input Power Requirements

#### *Input Power*

The supply has a universal AC input that accepts line voltage and frequency input within:

**100 – 240 V (+/- 10%), 50 – 60 Hz (+/- 5%)**

**100 – 127 V, 45 – 440 Hz**

Before connecting to an AC outlet or external power source, be sure that the power switch is in the OFF position and verify that the AC power cord, including the extension line, is compatible with the rated voltage/current and that there is sufficient circuit capacity for the power supply. Once verified, connect the cable firmly.

---

#### **⚠ WARNING**

**The included AC power cord is safety certified for this instrument operating in rated range. To change a cable or add an extension cable, be sure that it can meet the required power ratings for this instrument. Any misuse with wrong or unsafe cables will void the warranty.**

---

### 2.2 Output Connections

The waveform generator output circuits operate as a 50  $\Omega$  voltage source working into a 50  $\Omega$  load. At higher frequencies, a non-terminated or improperly terminated output may cause aberrations on the output waveform. In addition, loads with an impedance less than 50  $\Omega$  will reduce the waveform amplitude, while loads with an impedance greater than 50  $\Omega$  will increase waveform amplitude.

Excessive distortion or aberrations caused by improper termination are less noticeable at lower frequencies, especially with sine and triangle waveforms. To ensure waveform integrity, follow these precautions:



1. Use good quality 50  $\Omega$  coaxial cable and connectors.
2. Make all connections tight and as short as possible.
3. Use good quality attenuators, if it is necessary to reduce waveform amplitudes applied to sensitive circuits.
4. Use termination or impedance-matching devices to avoid reflections.
5. Ensure that attenuators and terminations have adequate power handling capabilities.

If there is a DC voltage across the output load, use a coupling capacitor in series with the load. The time constant of the coupling capacitor and load must be long enough to maintain pulse flatness.

### ***Impedance Matching***

If the waveform generator is driving a high impedance, such as a 1 M $\Omega$  input impedance (paralleled by a stated capacitance) of an oscilloscope vertical input, connect the transmission line to a 50  $\Omega$  attenuator, a 50  $\Omega$  termination and to the oscilloscope input. The attenuator isolates the input capacitance of the device and terminates the waveform generator properly.

## **2.3 Preliminary Check**

Complete the following steps to verify that the generator is ready for use.

### **1. Verify AC Input Voltage**

Verify and check to make sure proper AC voltages are available to power the instrument. The AC voltage range must meet the acceptable specification as explained in section 2.1.

### **2. Connect Power**

Connect AC power cord to the AC receptacle in the rear panel and press the power switch to the ON position to turn ON the instrument. The instrument will have a boot screen while loading, after which the main screen will be displayed.

### **3. Self Test**

Press **Utility**, and select **Test/Cal** option. Then, select **SelfTest** option. The instrument has 4 self-test options: screen test, key test, LED test, and board test.

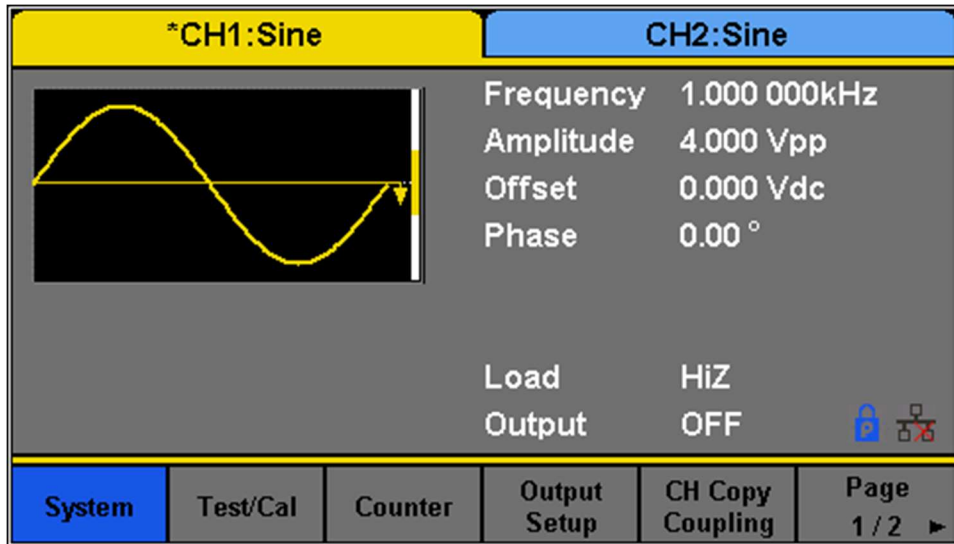

Figure 1 - Preliminary Self-Test

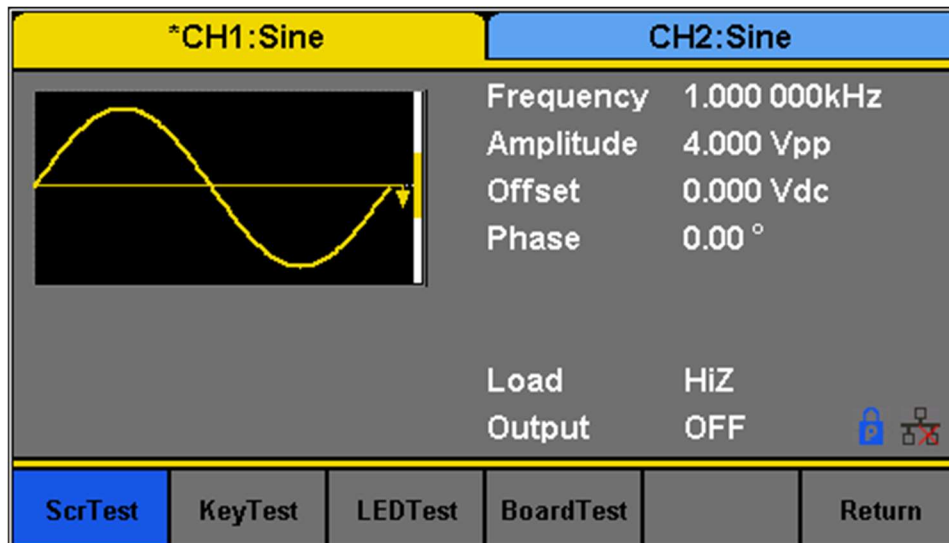

Figure 2 - Self-Test Options

---

**Note:** Refer to TEST/CAL section for more information about the Self-Test function.

---

### ***Check Model and Firmware Version***

The model and firmware version can be verified from within the menu system.

Press **Utility**, press **System** select and press **Page 1/2** from the menu to enter the second menu page, and select **System Info** option. The software/firmware version, hardware version, model, and serial number will be displayed. Press any **Menu Softkey** key to exit.

## Output Check

Follow the steps below to do a quick check of the settings and waveform output.

1. Turn on the instrument and set the instrument to default settings. To set to default, press **Utility** → **System** → **Set To Default** to set the system to the default setting. The instrument will set both channels with the following parameters:

<b>Output</b>	<b>Default</b>
Function	Sine Wave
Frequency	1 kHz
Amplitude/Offset	4 Vpp/0 Vdc
Phase	0°
Load	High Z
<b>Modulation</b>	<b>Default</b>
Carrier	1 kHz Sine wave
Modulating	100 Hz Sine wave
AM Depth	100%
FM Deviation	100 Hz
ASK Key Frequency	100 Hz
FSK Key Frequency	100 Hz
FSK Hop Frequency	1 MHz
PSK Key Frequency	10 0Hz
PM Phase Deviation	100°
PWM Width Dev	190 μs
<b>Sweep</b>	<b>Default</b>
Start/Stop Frequency	500 Hz/1.5 kHz
Sweep Time	1 s
Trig Out	Off
Mode	Linear
Direction	↑
<b>Burst</b>	<b>Default</b>
Burst Period	10 ms

Start Phase	0°
Cycles	1 Cycle
Trig Out	Off
Delay	521 ns
<b>Trigger</b>	<b>Default</b>
Source	Internal

**Table 1 - Default Settings**

1. Connect the BNC output of CH1 (yellow) into an oscilloscope.
  2. Press the **Output** button on top of CH1 output BNC to turn on the output and observe a sine wave with the parameters above.
  3. Press the **Parameter** button.
  4. Press **Freq** or **Period** option in the menu and use the rotary knob or the numeric keypad to change frequency. Observe the changes on the oscilloscope display.
  5. Press the **Amplitude** option in the menu and use the rotary knob or the numeric keypad to change the amplitude. Observe the changes on the oscilloscope display. Press the **Offset** option in the menu and use the rotary knob or the numeric keypad to change the DC offset. With the oscilloscope set for DC coupling, observe the changes on the display.
- Connect the BNC output of CH2 (blue) into an oscilloscope and follow steps 3 to 6 to check its output. Use the **Ch1/Ch2** to toggle between channels.

## 3 Front Panel Operation

### 3.1 Menu Options

All settings and parameters can be configured from the menu system of the instrument. The channel specific menu options are the same for both channel 1 and channel 2. Use the **Ch1/Ch2** button keys to toggle the channel selection. The selected option will be highlighted in blue. Some settings are common for most waveforms (i.e. frequency, amplitude, offset, etc.) and some are specific to each type of waveform (i.e. Duty cycle only available for square and pulse waveforms). Section 3.3 provides instructions on how to configure these settings.

Many options are grouped in pairs and can be selected by toggling their corresponding menu function keys. For example:

Frequency	Amplitude	Offset	Phase	Harmonic
Period	HighLevel	LowLevel		Off
Softkey will toggle selection between Frequency or Period.	Softkey will toggle selection between Amplitude or HighLevel.	Softkey will toggle selection between Offset or LowLevel.	Softkey will select Phase.	Softkey will enable or disable the Harmonic Generation Function.

Table 2 - Menu Options Softkeys

The menu system is organized as follows:

Waveforms	Parameter	Function
Sine	Frequency/Period	Configures the frequency or period of the waveform.
	Amplitude/HighLevel	Configures the amplitude or the high level of the waveform.
	Offset/LowLevel	Configures the DC offset or the low level of the waveform.
	Phase	Configures the phase relative to the other channel.
	Harmonic/Off	Turns Harmonics Generator on or off. See Harmonics Generator section.
Square	Frequency/Period	Configures the frequency or period of the waveform.
	Amplitude/HighLevel	Configures the amplitude or the high level of the waveform.

	<b>Offset/LowLevel</b>	Configures the DC offset or the low level of the waveform.
	<b>Phase</b>	Configures the phase relative to the other channel.
	<b>DutyCycle</b>	Configures the duty cycle of the waveform.
<b>Ramp</b>	<b>Frequency/Period</b>	Configures the frequency or period of the waveform.
	<b>Amplitude/HighLevel</b>	Configures the amplitude or the high level of the waveform.
	<b>Offset/LowLevel</b>	Configures the DC offset or the low level of the waveform.
	<b>Phase</b>	Configures the phase relative to the other channel.
	<b>Symmetry</b>	Configures the symmetry of the waveform.
<b>Pulse</b>	<b>Frequency/Period</b>	Configures the frequency or period of the waveform.
	<b>Amplitude/HighLevel</b>	Configures the amplitude or the high level of the waveform.
	<b>Offset/LowLevel</b>	Configures the DC offset or the low level of the waveform.
	<b>PulWidth/DutyCycle</b>	Configures the pulse width or the duty cycle of the pulse.
	<b>Rise/Fall</b>	Configures the rise or fall time of the pulse.
	<b>Delay</b>	Configures the delay of the pulse waveform.
<b>Noise</b>	<b>Stdev</b>	Configures the standard deviation of the noise waveform.
	<b>Mean</b>	Configures the mean value of the noise waveform.
<b>DC</b>	<b>DC Offset</b>	Configures the DC offset of the DC waveform.
<b>Arb</b>	<b>Frequency/Period</b>	Configures the frequency or period of the waveform.
	<b>Amplitude/HighLevel</b>	Configures the amplitude or the high level of the waveform.
	<b>Offset/LowLevel</b>	Configures the DC offset or the low level of the waveform.
	<b>Phase</b>	Configures the phase relative to the other channel.
	<b>Arb Type</b>	Access selectable built-in arbitrary waveforms and user-defined arbitrary waveform stored in the generator.
<b>Mod</b>		
	<b>Type</b>	Configures the type of modulation. Configures parameters for AM, FM, PM, ASK, FSK, DSB-AM, or PWM modulation.

	<b>Source</b>	Selects modulating source.
	<b>AM Depth</b>	Set the modulation depth.
	<b>Shape</b>	Configures the modulating waveform shape.
	<b>AM Freq</b>	Set the modulating waveform frequency. Frequency range: 1 mHz to 20 kHz (internal source only).
<b>Sweep</b>		
	<b>Sweep Time</b>	Configures the sweep time for sweep output.
	<b>StartFreq/CenterFreq</b>	Configures the sweep start frequency or the center frequency.
	<b>StopFreq/FreqSpan</b>	Configures the sweep stop frequency or the frequency span of the sweep output.
	<b>Source</b>	Selects the sweep source: Internal, external or manual.
	<b>Trig Out</b>	Enable/disable trigger out.
	<b>Type</b>	Selects between linear or logarithmic sweep operations.
	<b>Direction</b>	Selects the sweep direction.
<b>Burst</b>		
	<b>Ncycle/Gated</b>	Selects burst by number of cycles or selects external gated burst.
	<b>Cycles/Infinite</b>	Configures number of cycles for burst or infinite burst (external source only).
	<b>Start Phase</b>	Configures the start phase of the burst output.
	<b>Burst Period</b>	Configures the burst period.
	<b>Source</b>	Selects trigger source: Internal, External, Manual.
	<b>Trig Delay</b>	Configures the delay of each burst.
	<b>Trig Out</b>	Configures signal triggering on rising or falling edge.
<b>Utility</b>		
	<b>System</b>	Access system settings.
	<b>Test/Cal</b>	Configure synchronization output with respect to either channel 1 or 2.
	<b>Counter</b>	Selects built-in counter function.

	<b>Output Setup</b>	Set the output parameters of CH1 and CH2.
	<b>CH Copy Coupling</b>	Set the track, channel coupling or channel copy function.
	<b>Interface</b>	Select and set parameters of remote communication.
	<b>Clock</b>	Choose the system clock source: internal or external.
	<b>Mode</b>	Choose Phase-locked or independent mode.
	<b>OverVoltage Protection</b>	Turn on/off the overvoltage protection function.

Table 3 - Menu System Organization

### CHCopy

Copy channel settings between channels.

## 3.2 Selecting a Channel

The 4050B series function/arbitrary waveform generators have dual channel outputs. They can be operated independently or in sync with each other. To select between channel 1 and 2 and view/change their parameters, press the **Ch1/Ch2** key.

When **Channel 1** is selected, the display will look like the following:

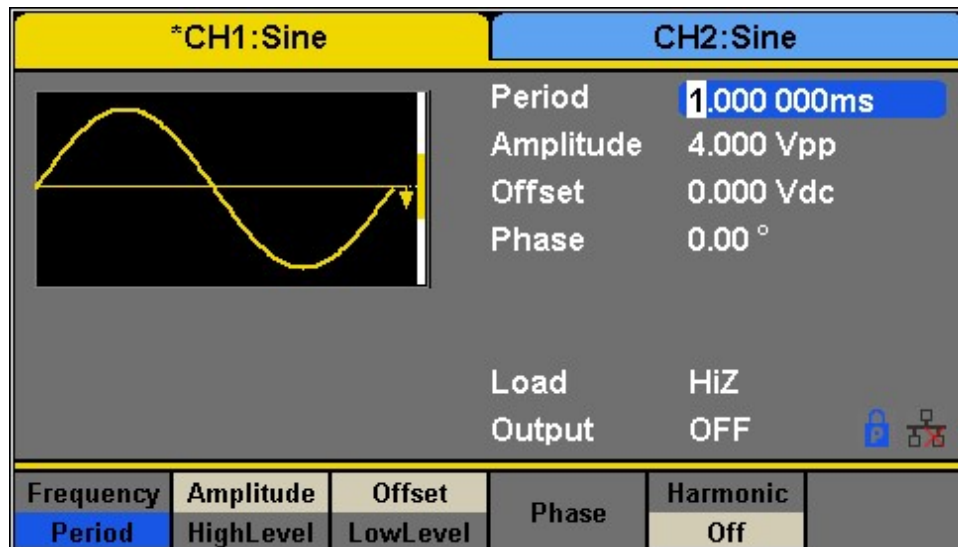

Figure 3 – Channel 1 Selected

When **Channel 2** is selected, the display will look like the following:



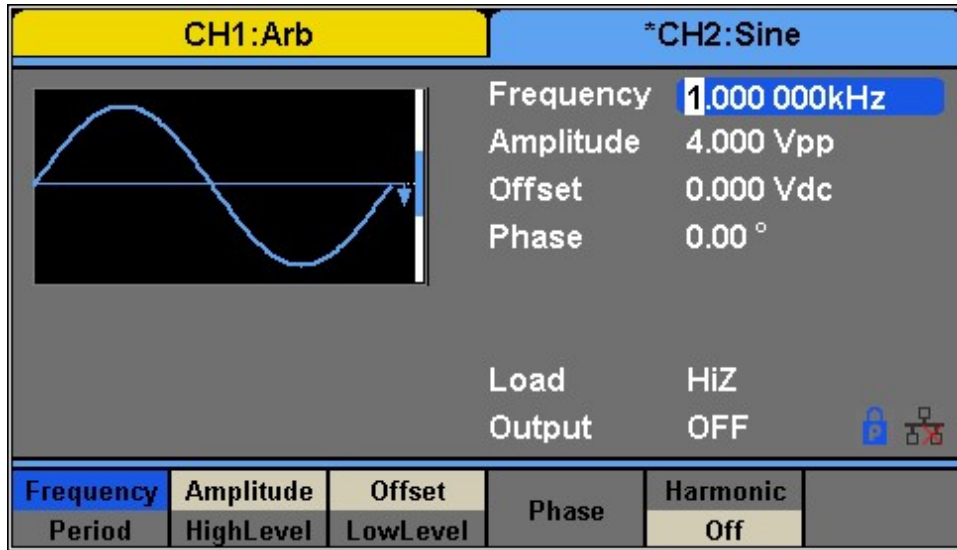

Figure 4 - Channel 2 Selected

### 3.3 Configure Waveform Output







#### *Configure Waveform Shape*

The instrument can generate many standard as well as arbitrary waveforms. There is a dedicated waveform key on the front panel that will allow the user to select between different waveform shapes to output, as listed in Table 4.

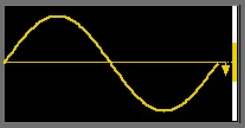
Waveforms
Sine
Square
Ramp
Pulse
Noise
DC
Arbitrary

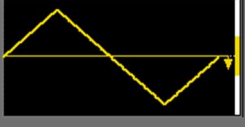
Table 4 - Waveforms

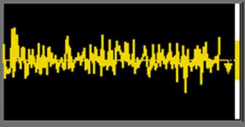
Press **Waveforms** to select a waveform. Menu options relevant to the selected waveform shape will display at the bottom of the screen. The screenshots below illustrates the menu options for each of the waveform types.

<h3 style="text-align: center;">Sine Waveform</h3> <div style="display: flex; justify-content: space-between;"> <span>*CH1:Sine</span> <span>CH2:Sine</span> </div>  <div style="display: flex; justify-content: space-between;"> <div> <p>Period <b>1.000 000ms</b></p> <p>Amplitude 4.000 Vpp</p> <p>Offset 0.000 Vdc</p> <p>Phase 0.00 °</p> </div> <div> <p>Load HiZ</p> <p>Output OFF</p> </div> </div> <table border="1" style="width: 100%; text-align: center;"> <tr> <td>Frequency</td> <td>Amplitude</td> <td>Offset</td> <td>Phase</td> <td>Harmonic</td> </tr> <tr> <td>Period</td> <td>HighLevel</td> <td>LowLevel</td> <td></td> <td>Off</td> </tr> </table>	Frequency	Amplitude	Offset	Phase	Harmonic	Period	HighLevel	LowLevel		Off	<h3 style="text-align: center;">Square Waveform</h3> <div style="display: flex; justify-content: space-between;"> <span>*CH1:Square</span> <span>CH2:Sine</span> </div>  <div style="display: flex; justify-content: space-between;"> <div> <p>Period <b>1.000 000ms</b></p> <p>Amplitude 4.000 Vpp</p> <p>Offset 0.000 Vdc</p> <p>Phase 0.00 °</p> <p>Duty 50.000 %</p> </div> <div> <p>Load HiZ</p> <p>Output OFF</p> </div> </div> <table border="1" style="width: 100%; text-align: center;"> <tr> <td>Frequency</td> <td>Amplitude</td> <td>Offset</td> <td>Phase</td> <td>DutyCycle</td> </tr> <tr> <td>Period</td> <td>HighLevel</td> <td>LowLevel</td> <td></td> <td></td> </tr> </table>	Frequency	Amplitude	Offset	Phase	DutyCycle	Period	HighLevel	LowLevel				
Frequency	Amplitude	Offset	Phase	Harmonic																			
Period	HighLevel	LowLevel		Off																			
Frequency	Amplitude	Offset	Phase	DutyCycle																			
Period	HighLevel	LowLevel																					
<h3 style="text-align: center;">Ramp Waveform</h3> <div style="display: flex; justify-content: space-between;"> <span>*CH1:Ramp</span> <span>CH2:Sine</span> </div>  <div style="display: flex; justify-content: space-between;"> <div> <p>Frequency 1.000 000kHz</p> <p>Amplitude 4.000 Vpp</p> <p>Offset 0.000 Vdc</p> <p>Phase 0.00 °</p> <p>Symmetry <b>50.0 %</b></p> </div> <div> <p>Load HiZ</p> <p>Output OFF</p> </div> </div> <table border="1" style="width: 100%; text-align: center;"> <tr> <td>Frequency</td> <td>Amplitude</td> <td>Offset</td> <td>Phase</td> <td>Symmetry</td> </tr> <tr> <td>Period</td> <td>HighLevel</td> <td>LowLevel</td> <td></td> <td></td> </tr> </table>	Frequency	Amplitude	Offset	Phase	Symmetry	Period	HighLevel	LowLevel			<h3 style="text-align: center;">Pulse Waveform</h3> <div style="display: flex; justify-content: space-between;"> <span>*CH1:Pulse</span> <span>CH2:Sine</span> </div>  <div style="display: flex; justify-content: space-between;"> <div> <p>Frequency 1.000 000kHz</p> <p>Amplitude 4.000 Vpp</p> <p>Offset 0.000 Vdc</p> <p>Pulse Width <b>200.000us</b></p> <p>Rise Edge 16.8ns</p> <p>Delay 0.000 000 s</p> </div> <div> <p>Load HiZ</p> <p>Output OFF</p> </div> </div> <table border="1" style="width: 100%; text-align: center;"> <tr> <td>Frequency</td> <td>Amplitude</td> <td>Offset</td> <td>PulWidth</td> <td>Rise</td> <td>Delay</td> </tr> <tr> <td>Period</td> <td>HighLevel</td> <td>LowLevel</td> <td>DutyCycle</td> <td>Fall</td> <td></td> </tr> </table>	Frequency	Amplitude	Offset	PulWidth	Rise	Delay	Period	HighLevel	LowLevel	DutyCycle	Fall	
Frequency	Amplitude	Offset	Phase	Symmetry																			
Period	HighLevel	LowLevel																					
Frequency	Amplitude	Offset	PulWidth	Rise	Delay																		
Period	HighLevel	LowLevel	DutyCycle	Fall																			
<h3 style="text-align: center;">Noise Waveform</h3> <div style="display: flex; justify-content: space-between;"> <span>*CH1:Noise</span> <span>CH2:Sine</span> </div>  <div style="display: flex; justify-content: space-between;"> <div> <p>Stdev <b>415.2mV</b></p> <p>Mean 0.000 V</p> </div> <div> <p>Load HiZ</p> <p>Output OFF</p> </div> </div> <table border="1" style="width: 100%; text-align: center;"> <tr> <td>Stdev</td> <td>Mean</td> </tr> </table>	Stdev	Mean	<h3 style="text-align: center;">DC Waveform</h3> <div style="display: flex; justify-content: space-between;"> <span>*CH1:DC</span> <span>CH2:Sine</span> </div>  <div style="display: flex; justify-content: space-between;"> <div> <p>DC Offset <b>0.000 V</b></p> </div> <div> <p>Load HiZ</p> <p>Output OFF</p> </div> </div> <table border="1" style="width: 100%; text-align: center;"> <tr> <td>Offset</td> </tr> </table>	Offset																			
Stdev	Mean																						
Offset																							
<h3>Arbitrary Waveform</h3>																							

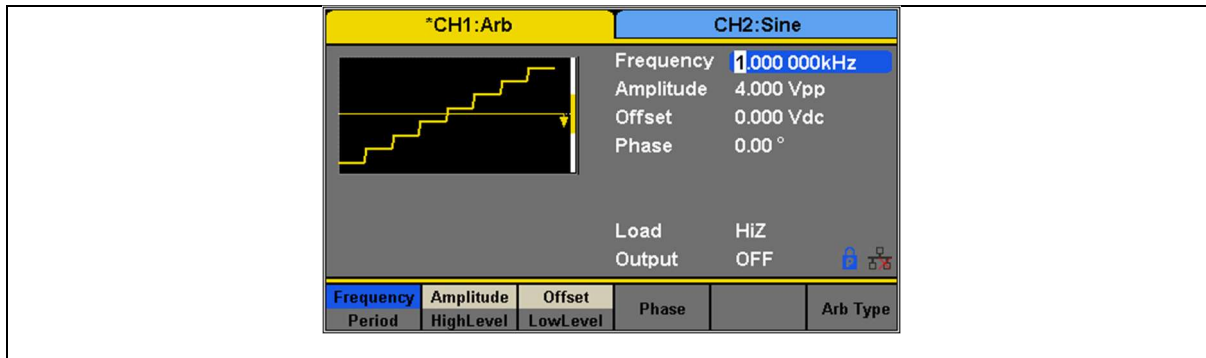

Table 5 - Waveforms

### Configure Frequency

*This section does not apply to noise or DC waveforms.*

Press the **Frequency/Period** softkey to toggle between the Frequency and Period settings. The option selected will be highlighted in blue. The current value for the waveform's frequency or period is now highlighted on the Waveform Parameters display section of the screen.

The adjustable frequency range is different for each model and for each type of waveforms. See the specifications sheet section for the adjustable ranges.

Follow the steps below to configure the frequency or period of the output:

1. After selecting the waveform shape, press the **Frequency/Period** menu option.
2. The cursor position will now highlight the first digit of the frequency parameter display.
3. Use the rotary knob or the numeric keypad to change the frequency. If numeric keypad is used, the following screen will be displayed after entering a numeric value:

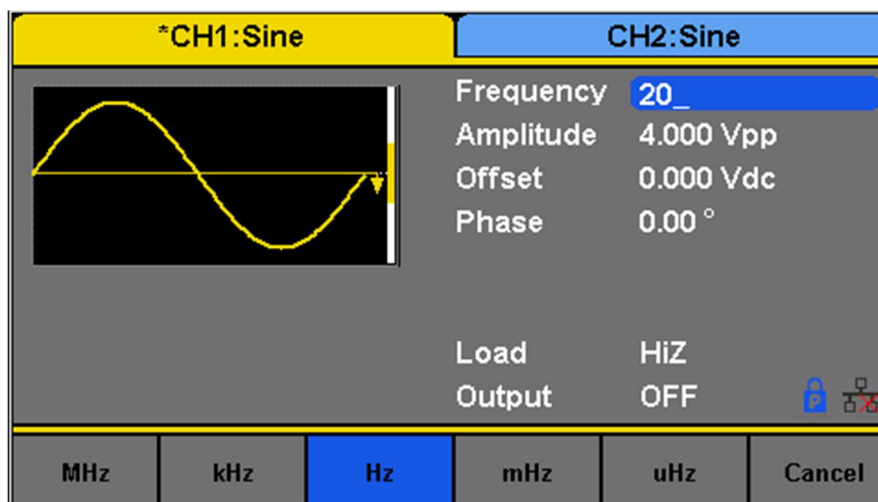

Figure 5 - Frequency

4. Use the menu function keys to select the unit. Available units are: **MHz**, **kHz**, **Hz**, **mHz**, and **uHz**.

---

**Note:** When using the numeric keyboard to enter the value, the left arrow key can be used to move the cursor backward and delete the previous digit.

---

### **Configure Amplitude**

*This section does not apply for noise or DC waveform.* The amplitude setting range is limited by the load and frequency, as shown below:

2 mVpp – 10 Vpp into 50  $\Omega$  (4 mVpp – 20 Vpp into open circuit),  $\leq$  10 MHz

2 mVpp – 5 Vpp into 50  $\Omega$  (4 mVpp – 10 Vpp into open circuit),  $>$  10 MHz

Follow the steps below to configure the amplitude of the output:

1. Press the **Waveforms** button.
2. Select a waveform from the menu.
3. Press the **Amplitude** softkey. The cursor position now highlights the first digit of the amplitude parameter display.
4. Use the rotary knob or the numeric keypad to change the amplitude.
  - a. If numeric keypad is used, the following screen will be displayed after entering a number:

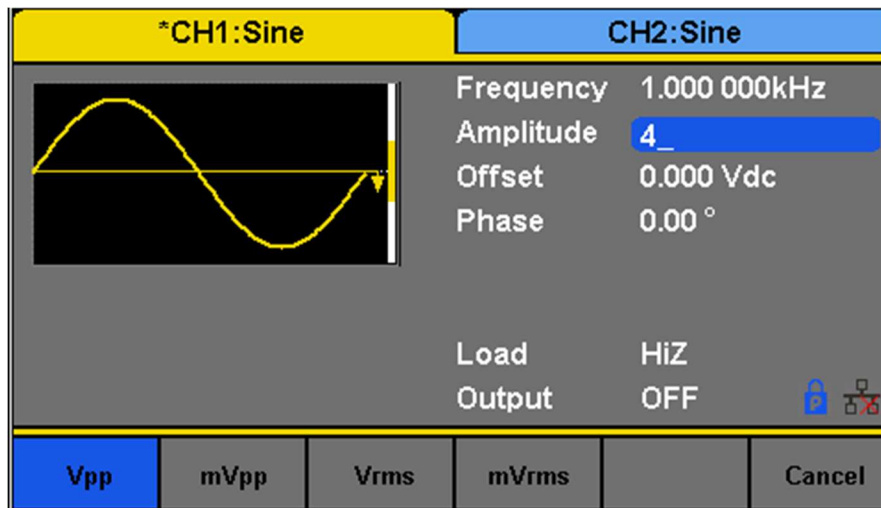

Figure 6 - Amplitude

5. Use the menu function keys to select the unit. Available units are: **Vpp**, **mVpp**, **Vrms**, and **mVrms**.

## User-Defined High and Low Level

The user has the option to adjust the high and low level of the waveform. To do this, toggle the menu function key from **Amplitude** to **HighLevel** and the **LowLevel** option will be available as well.

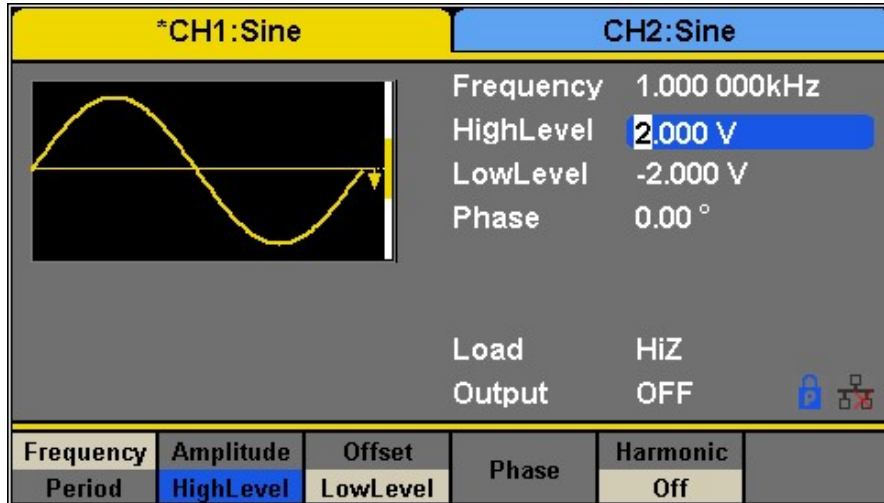

Figure 7 - Amplitude: High and Low Level

---

**Note:** DC offset settings will be automatically adjusted if the high and low levels reflect a DC offset.

---

## Configure Offset

*This section does not apply to noise waveform.* The offset setting range is limited by the “Load” and “Amplitude/HighLevel” settings. The range is:  $\pm 5$  V into  $50 \Omega$  ( $\pm 10$  V into open circuit). The default value is 0 Vdc.

Follow the steps below to configure the DC offset of the output:

1. Press the **Waveforms** button.
2. Select a waveform from the menu.
3. Press the **Offset** softkey.
4. The cursor position now highlights the first digit of the offset parameter display.
5. Use the rotary knob or the numeric keypad to change the offset. If numeric keypad is used, the following screen will be displayed after entering a number:

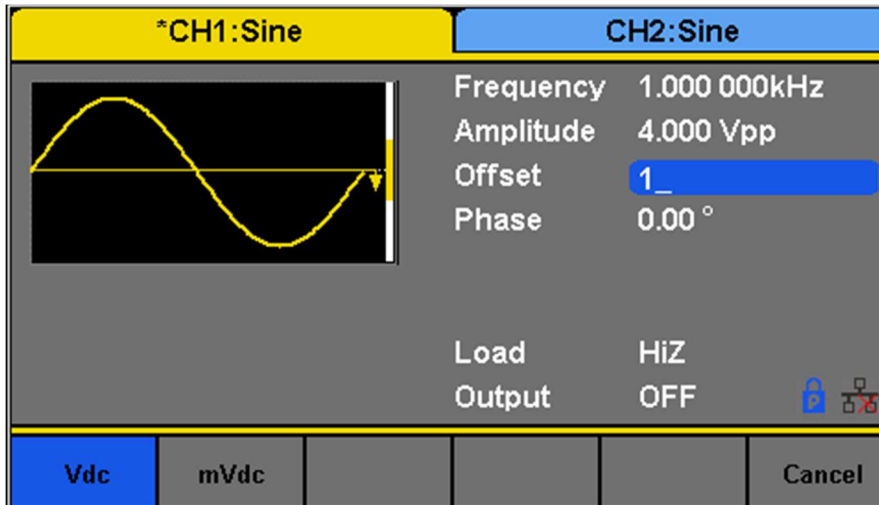

Figure 8 - Offset

- Use the menu function keys to select the unit. Available units are: **Vdc** and **mVdc**.

### **Configure Phase**

*This section does not apply for pulse, noise, or DC waveforms.*

The Phase setting is useful for adjusting the phase relationship between channels 1 and 2, between a channel and its sync signal, and synchronizing multiple instruments. This setting is different from the Start Phase in Burst mode.

#### **Follow the steps below to configure the phase of the output:**

- Press the **Waveforms** button.
- Select a waveform from the menu.
- Press the **Phase** softkey.
- The cursor position now highlights the first digit of the phase parameter display.
- Use the rotary knob or the numeric keypad to change the phase. If numeric keypad is used, the following screen will be displayed after entering a number:

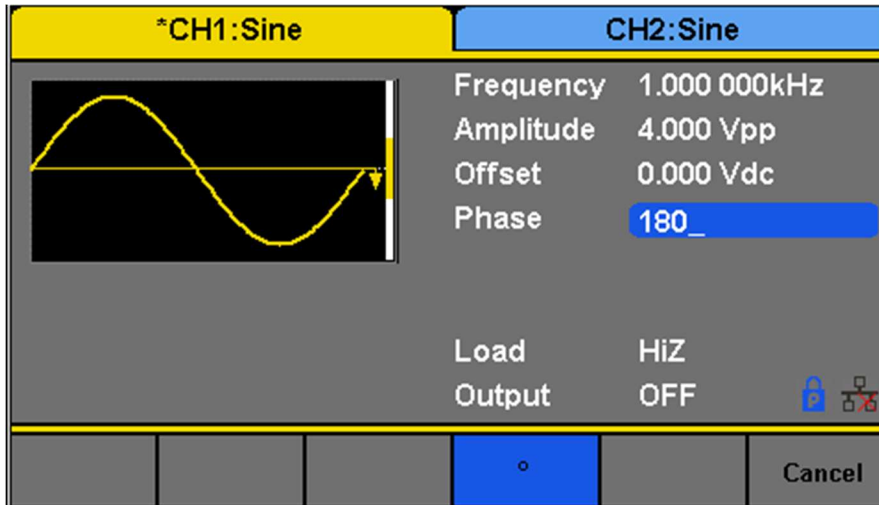

Figure 9 - Phase

6. Use the menu function keys to select the degree (°) unit.

---

**Note:** When the IndependentMode is enabled, the phase parameter cannot be modified (i.e., the phase can only be set when there is a reference clock waveform provided on the back panel).

---

### ***Configure Duty Cycle: Square Waveform***

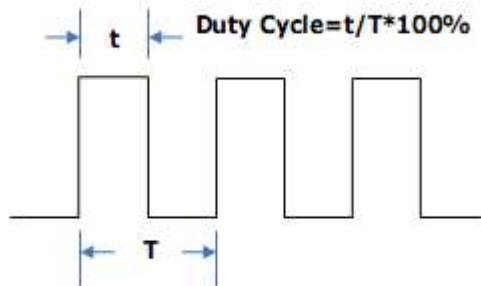

Figure 10 - Duty Cycle

The duty cycle setting range is limited by the “Frequency/Period” setting. The default value is 50%.

Follow the steps below to configure the phase of the output:

1. Press the **Waveforms** button and select the **Square** waveform.
2. Press the **DutyCycle** softkey and input the desired duty cycle.
3. Use the rotary knob or the numeric keypad to change the duty cycle. If numeric keypad is used, the following screen will be displayed after entering a number:

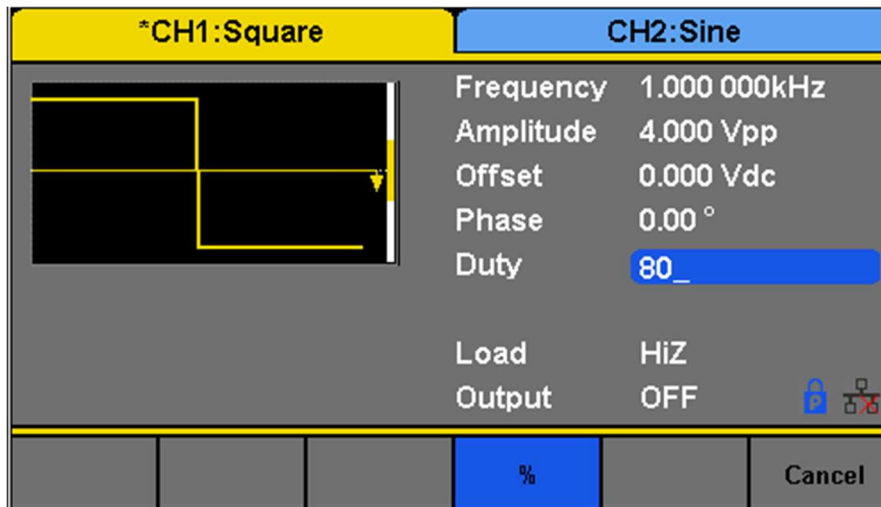

Figure 11 - Duty Cycle of a Square Waveform

- Use the menu function keys to select the degree (°) unit.

### ***Configure Width and Duty Cycle: Pulse Waveform***

The pulse width and duty cycle parameters are related to each other and both control the length of the “On Time” of a pulse. Users have the option to specify the pulse width in units of seconds or the duty cycle as a percentage. Pulse duty cycle and pulse width are dependent—changing one of the parameters will automatically change the other.

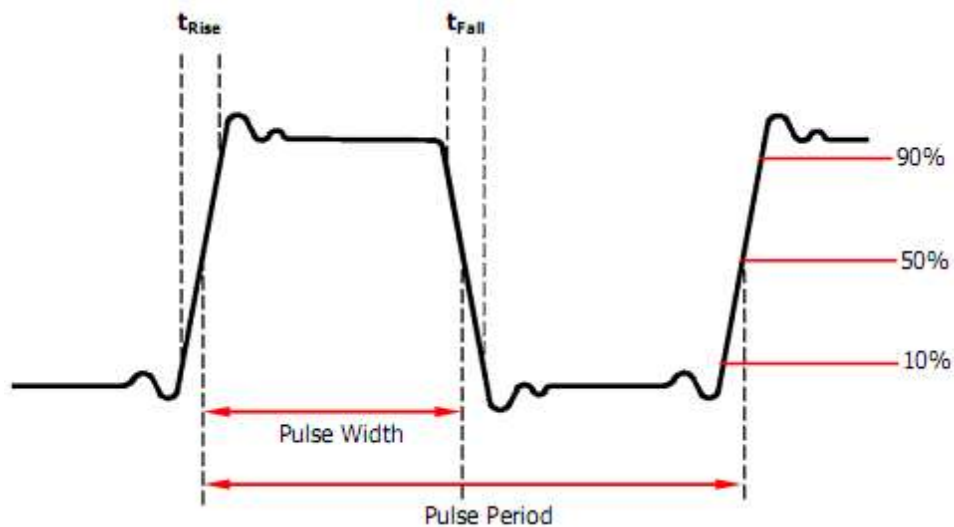

Figure 12 - Pulse Width and Period

---

**Note:** The instrument allows for adjusting pulse width to a minimum of 32.6 ns, depending on frequency.

---



Follow the steps below to configure the pulse width or duty cycle.

1. Press the **Waveforms** button.
2. Press the **Pulse** softkey.
3. Select **PulWidth** softkey for pulse width adjustment or **DutyCycle** for duty cycle adjustment.
4. The cursor position will now highlight the first digit of the width or duty parameter display.



Figure 13 - Pulse Width or Duty Cycle

5. Use the rotary knob or the numeric keypad to change the width or the duty. After entering the numeric value, use the menu function keys to select **s**, **ms**, **us**, or **ns** for pulse width or select percent (%) unit for duty cycle.

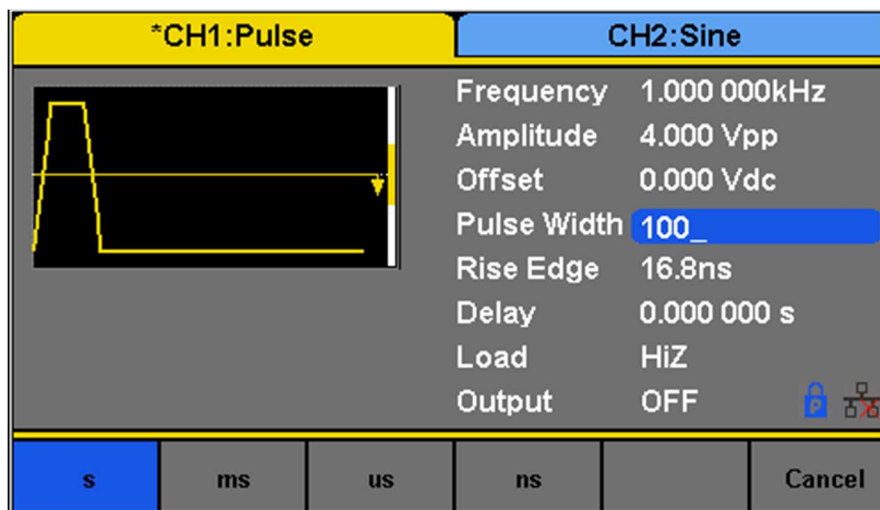

Figure 14 - Pulse Width

### Configure Rise/Fall Edge: Pulse Waveform

Follow the below steps to setup rise and fall time.

1. Press the **Waveforms** button.
2. Press the **Pulse** softkey.

3. Toggle the **Rise/Fall** softkey to set the rise or fall edge.

The Rise/Fall softkey lets the user toggle between the Rise and Fall Edge settings. The selected setting will be highlighted in blue.

Use the numeric keyboard to input the parameter value directly and press the corresponding key to select the parameter unit. Alternatively, use the arrow keys to select the digit and use the knob to change its value.

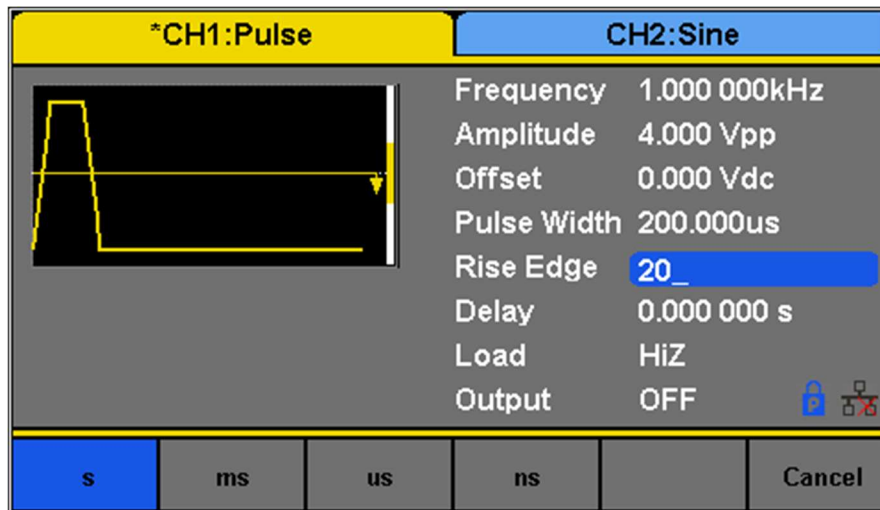

Figure 15 - Rise Edge of a Pulse

### ***Configure Delay: Pulse Waveform***

Follow the steps below to configure the pulse delay.

1. Set the instrument for pulse.
2. From the menu, select **Delay**.
3. The cursor position will now highlight the first digit of the delay parameter display.

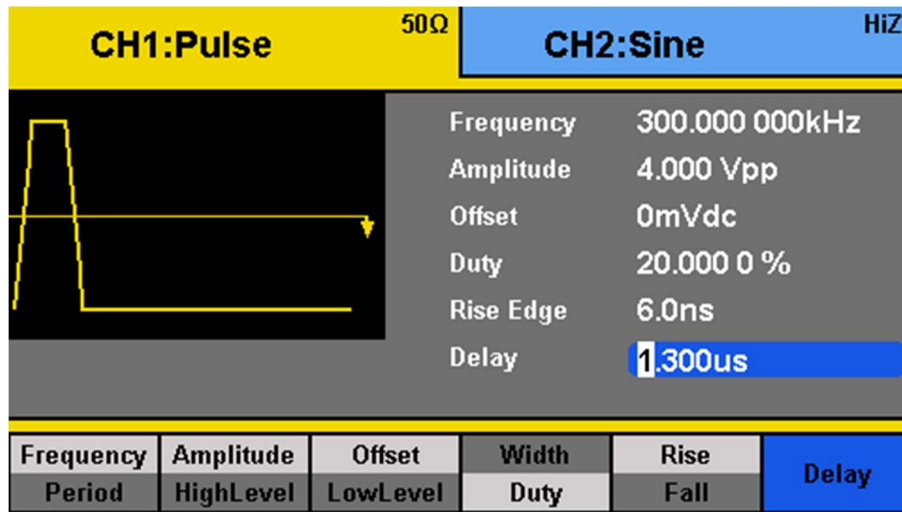

Figure 16 - Pulse Delay

- Use the rotary knob or the numeric keypad to change the pulse delay.  
After entering the numeric value, use the menu function keys to select **s**, **ms**, **us**, or **ns**.

### Configure Symmetry: Ramp Waveform

A ramp waveform with 50% of symmetry is a triangular waveform. A sawtooth waveform is a ramp waveform with either 0 or 100 percent.

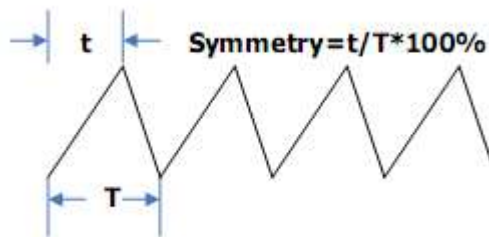

Figure 17 - Symmetry

Follow the steps below to configure the symmetry of a ramp/triangle waveform.

- Press the **Waveforms** button.
- Select and press the **Ramp** waveform softkey from the menu.
- The cursor position will now highlight the first digit of the symmetry parameter display.

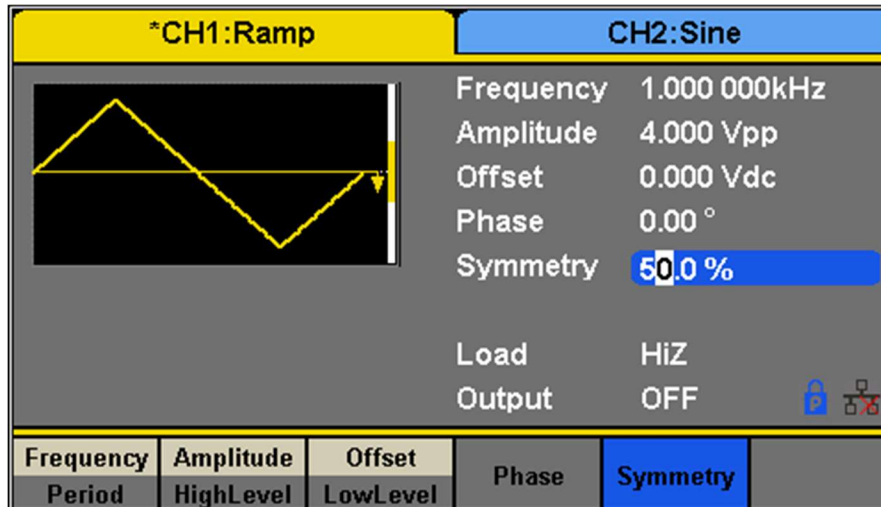

Figure 18 - Ramp Symmetry

4. Use the rotary knob or the numeric keypad to change the symmetry.
5. Once the value has been entered, press the “%” softkey from the menu to set the value.

### ***Configure Standard Deviation and Mean: Noise Waveform***

There are two parameters that can be adjusted of the noise waveform: Standard deviation and mean. Noise is a non-periodic random signal which has no frequency or period.

Follow the steps below to configure these parameters.

1. Press the **Waveforms** button.
2. Select and press the **Noise** waveform softkey from the menu.
3. From the menu, select **Stdev** for the standard deviation adjustment or **Mean** for the mean adjustment.
4. The cursor position will now highlight the first digit of the standard deviation or mean parameter display.

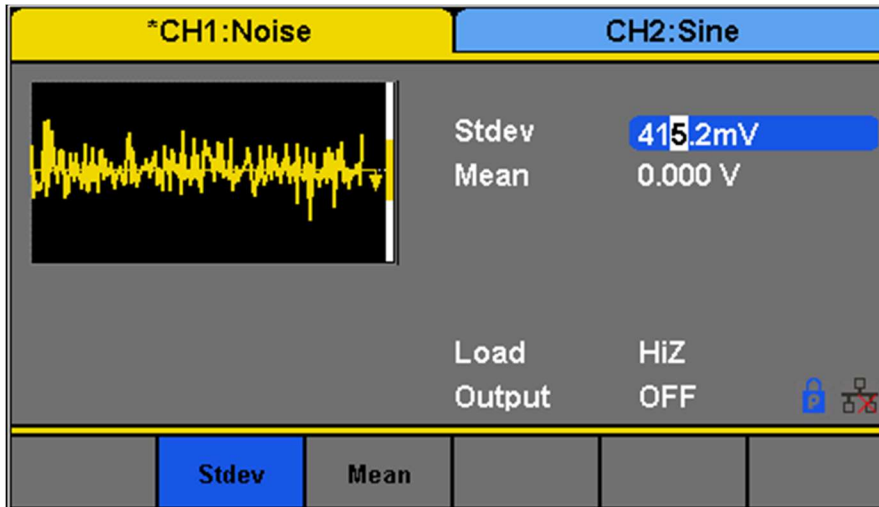

Figure 19 - Noise Standard Deviation

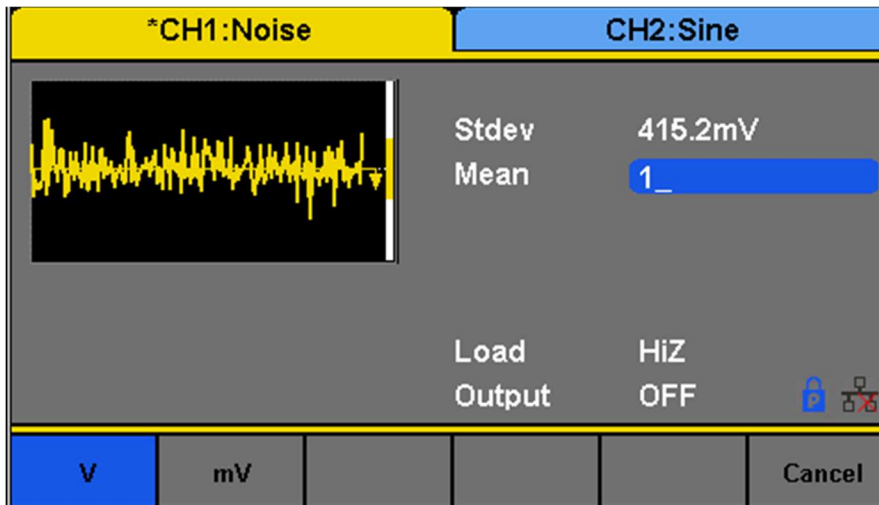

Figure 20 - Noise Mean

5. Use the rotary knob or the numeric keypad to change the two parameters. Both parameters can be specified in **V** or **mV** units.

### ***Configure Offset: DC Waveform***

The instrument can output a DC waveform output at a range of voltage levels (-12 Vdc – 12 Vdc).

There is only one parameter, DC Offset, to configure a DC output waveform.

Follow the steps below to configure the parameter.

1. Press the Waveforms button.

2. Select and press the **DC** waveform softkey from the menu.
3. The cursor position will now be highlighted the first digit of the DC offset parameter display.

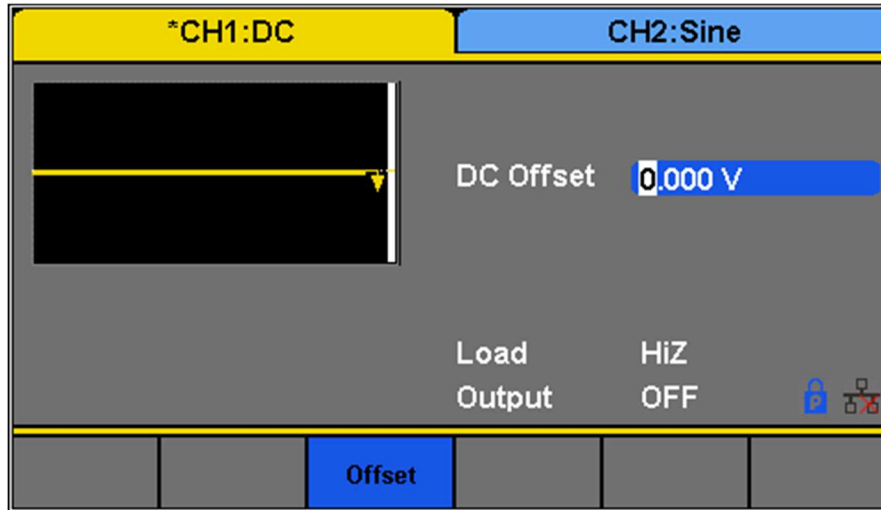

Figure 21 - DC Offset

4. Use the rotary knob or the numeric keypad to change the two parameters. Both parameters can be specified in **Vdc** or **mVdc** units.

### ***Configure Arbitrary Waveforms***

There are two ways to generate arbitrary waveforms. Users can output a predefined arbitrary waveform that is built-in, or create and output a user-defined waveform by specifying point by point arbitrary data using the EasyWave software. Waveforms can be stored in the internal non-volatile memory. The methods of setting the parameters of an arbitrary waveform signal are similar to those of the sine waveform function.

#### **Generate Predefined Built-in Waveforms**

There are a total of 196 predefined built-in arbitrary waveforms that can output from the generator. They are divided in the following categories:

**Arbitrary Waveform: Common**

Waveform	Function		Waveform	Function
StairUp	Stair-up waveform		Npulse	Negative pulse
StairDn	Stair-down waveform		UpRamp	UpRamp waveform
StairUD	Stair-up and down waveform		DnRamp	DnRamp waveform
Trapezia	Trapezia waveform		SineTra	Sine-Tra waveform
Ppulse	Positive pulse		SineVer	Sine-Ver waveform

Arbitrary Waveform: Math				
Waveform	Function		Waveform	Function
ExpFall	ExpFall function		Legend	5-times Legend polynomial
ExpRise	ExpRise function		Versiera	Versiera
LogFall	LogFall function		Sinc	Sinc function
LogRise	LogRise function		Gaussian	Gaussian function
Sqrt	Sqrt function		Dlorentz	Dlorentz function
Root3	Root3 function		Haversine	Haversine function
X^2	X <sup>2</sup> function		Lorentz	Lorentz function
X^3	X <sup>3</sup> function		Gauspuls	Gauspuls signal
Airy	Airy function		Gmonopuls	Gmonopuls signal
Besselj	Bessel I function		Tripuls	Tripuls signal
Bessely	Bessel II function		Weibull	Weibull distribution
Dirichlet	Dirichlet function		LogNormal	LogNormal Gaussian distribution
Erf	Error function		Laplace	Laplace distribution
Erfc	Complementary error function		Maxwell	Maxwell distribution
Erfclnv	Inverted complementary error function		Rayleigh	Rayleigh distribution
ErfInv	Inverted error function		Cauchy	Cauchy distribution
Laguerre	4-times Laguerre polynomial			

<b>Arbitrary Waveform: Engine</b>				
<b>Waveform</b>	<b>Function</b>		<b>Waveform</b>	<b>Function</b>
Cardiac	Cardiac signal		SCR	SCR firing profile
Quake	Analog quake waveform		TV	TV signal
Chirp	Chirp signal		Voice	Voice signal
TwoTone	TwoTone signal		Surge	Surge signal
SNR	SNR signal		Radar	Analog radar signal
AmpALT	Gain oscillation curve		Ripple	Ripple wave of battery
AttALT	Attenuation oscillation curve		Gamma	Gamma signal
RoundHalf	RoundHalf Waveform		StepResp	Step-response signal
RoundsPM	RoundsPM Waveform		BandLimited	Bandwidth-limited signal
BlaseiWave	Time-velocity curve of explosive oscillation		CPulse	C-Pulse
DampedOsc	Time-displacement curve of damped oscillation		CWPulse	CW pulse
SwingOsc	Kinetic energy – time curve of swing oscillation		GateVibr	Gate self-oscillation signal
Discharge	Discharge curve of NI-MH battery		LFMPulse	Linear FM pulse
Pahcur	Current waveform of DC brushless motor		MCNoise	Mechanical construction noise
Combin	Combination function			

<b>Arbitrary Waveform: Window</b>				
<b>Waveform</b>	<b>Function</b>		<b>Waveform</b>	<b>Function</b>
Hamming	Hamming window		Bartlett	Bartlett window
Hanning	Hanning window		BarthannWin	Modified Bartlett-Hann window



Kaiser	Kaiser window		BohmanWin	BohmanWin window
Blackman	Blackman window		ChebWin	ChebWin window
GaussiWin	GaussiWin window		FlattopWin	Flat top weighted window
Triangle	Triangle window (Fejer window)		ParzenWin	ParzenWin window
BlackmanH	BlackmanH window		TaylorWin	TaylorWin window
Bartlett-Hann	Bartlett-Hann window		TukeyWin	TukeyWin (tapered cosine) window

<b>Arbitrary Waveform: Trigonometric (Trigo)</b>				
<b>Waveform</b>	<b>Function</b>		<b>Waveform</b>	<b>Function</b>
Tan	Tangent		Csch	Hyperbolic cosecant
Cot	Cotangent		SecH	Hyperbolic secant
Sec	Secant		SinH	Hyperbolic sine
Csc	Cosecant		SinInt	Integral sine
Asin	Arc sine		TanH	Hyperbolic tangent
Acos	Arc cosine		ACosH	Arc hyperbolic cosine
Atan	Arc tangent		ASecH	Arc hyperbolic secant
ACot	Arc cotangent		ASinH	Arc hyperbolic sine
CosH	Hyperbolic cosine		ATanH	Arc hyperbolic tangent
CosInt	Integral cosine		ACsch	Arc hyperbolic cosecant
Coth	Hyperbolic cotangent		ACoth	Arc hyperbolic cotangent

<b>Arbitrary Waveform: Square 1</b>				
<b>Waveform</b>	<b>Function</b>		<b>Waveform</b>	<b>Function</b>
SquareDuty01	Square waveform with 1% duty		SquareDuty36	Square waveform with 36% duty

SquareDuty02	Square waveform with 2% duty		SquareDuty38	Square waveform with 38% duty
SquareDuty04	Square waveform with 4% duty		SquareDuty40	Square waveform with 40% duty
SquareDuty06	Square waveform with 6% duty		SquareDuty42	Square waveform with 42% duty
SquareDuty08	Square waveform with 8% duty		SquareDuty44	Square waveform with 44% duty
SquareDuty10	Square waveform with 10% duty		SquareDuty46	Square waveform with 46% duty
SquareDuty12	Square waveform with 12% duty		SquareDuty48	Square waveform with 48% duty
SquareDuty14	Square waveform with 14% duty		SquareDuty50	Square waveform with 50% duty
SquareDuty16	Square waveform with 16% duty		SquareDuty52	Square waveform with 52% duty
SquareDuty18	Square waveform with 18% duty		SquareDuty54	Square waveform with 54% duty
SquareDuty20	Square waveform with 20% duty		SquareDuty56	Square waveform with 56% duty
SquareDuty22	Square waveform with 22% duty		SquareDuty58	Square waveform with 58% duty
SquareDuty24	Square waveform with 24% duty		SquareDuty60	Square waveform with 60% duty
SquareDuty26	Square waveform with 26% duty		SquareDuty62	Square waveform with 62% duty
SquareDuty28	Square waveform with 28% duty		SquareDuty64	Square waveform with 64% duty
SquareDuty30	Square waveform with 30% duty		SquareDuty66	Square waveform with 66% duty
SquareDuty32	Square waveform with 32% duty		SquareDuty68	Square waveform with 68% duty
SquareDuty34	Square waveform with 34% duty			

<b>Arbitrary Waveform: Square 2</b>				
<b>Waveform</b>	<b>Function</b>		<b>Waveform</b>	<b>Function</b>
SquareDuty70	Square waveform with 70% duty		SquareDuty86	Square waveform with 86% duty
SquareDuty72	Square waveform with 72% duty		SquareDuty88	Square waveform with 88% duty
SquareDuty74	Square waveform with 74% duty		SquareDuty90	Square waveform with 90% duty
SquareDuty76	Square waveform with 76% duty		SquareDuty92	Square waveform with 92% duty
SquareDuty78	Square waveform with 78% duty		SquareDuty94	Square waveform with 94% duty
SquareDuty80	Square waveform with 80% duty		SquareDuty96	Square waveform with 96% duty
SquareDuty82	Square waveform with 82% duty		SquareDuty98	Square waveform with 98% duty
SquareDuty84	Square waveform with 84% duty		SquareDuty99	Square waveform with 99% duty

<b>Arbitrary Waveform: Medical</b>				
<b>Waveform</b>	<b>Function</b>		<b>Waveform</b>	<b>Function</b>
EOG	Electro-Oculogram		ECG8	Electrocardiogram 8
EEG	Electroencephalogram		ECG9	Electrocardiogram 9
EMG	Electromyogram		ECG10	Electrocardiogram 10
Pulseilogram	Pulseilogram		ECG11	Electrocardiogram 11
ResSpeed	Speed curve of the respiration		ECG12	Electrocardiogram 12
ECG1	Electrocardiogram 1		ECG13	Electrocardiogram 13
ECG2	Electrocardiogram 2		ECG14	Electrocardiogram 14

ECG3	Electrocardiogram 3		ECG15	Electrocardiogram 15
ECG4	Electrocardiogram 4		LFPulse	Waveform of the low frequency pulse electrotherapy
ECG5	Electrocardiogram 5		Tens1	Waveform 1 of the nerve stimulation electrotherapy
ECG6	Electrocardiogram 6		Tens2	Waveform 2 of the nerve stimulation electrotherapy
ECG7	Electrocardiogram 7		Tens3	Waveform 3 of the nerve stimulation electrotherapy

<b>Arbitrary Waveform: Mod</b>				
<b>Waveform</b>	<b>Function</b>		<b>Waveform</b>	<b>Function</b>
AM	Sectional sine AM signal		PM	Sectional sine PM signal I
FM	Sectional sine FM signal		PWM	Sectional PWM signal
PFM	Sectional pulse FM signal			

<b>Arbitrary Waveform: Filter</b>				
<b>Waveform</b>	<b>Function</b>		<b>Waveform</b>	<b>Function</b>
Butterworth	Butterworth filter		Chebyshev2	Chebyshev2 filter
Chebyshev1	Chebyshev1 filter			

<b>Arbitrary Waveform: Demo</b>				
<b>Waveform</b>	<b>Function</b>		<b>Waveform</b>	<b>Function</b>
demo1_375 pts	TrueArb waveform 1, 375 pts		demo2_3 kpts	TrueArb waveform 2, 3000 pts
demo1_16 Kpts	TrueArb waveform 1, 16384 pts		demo2_16 kpts	TrueArb waveform 2, 16384 pts

Follow the steps below to browse and select a predefined arbitrary waveform.

1. Press the **Waveforms** button.
2. Go to the second page of waveform options by pressing the **1/2** softkey.
3. Select and press the **Arb** softkey from the menu.

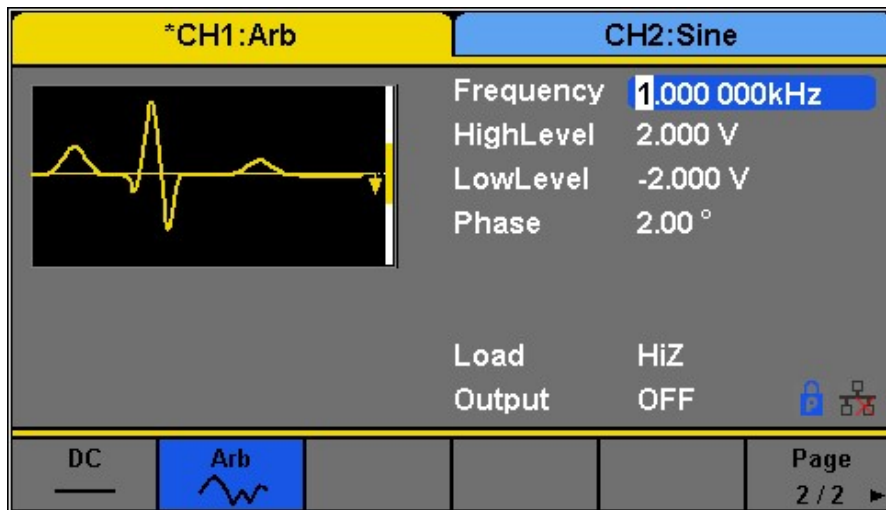

Figure 22 - Arbitrary Waveform

4. Select **Built-in** from the parameter menu and there will be a table on the display area showing the available built-in waveforms. The menu will display the waveform categories: Common, Math, Engine, etc.
5. After selecting the category (selected category will be highlighted in blue), use the rotary knob to select the desired predefined waveform (selected waveform will be highlighted in white).

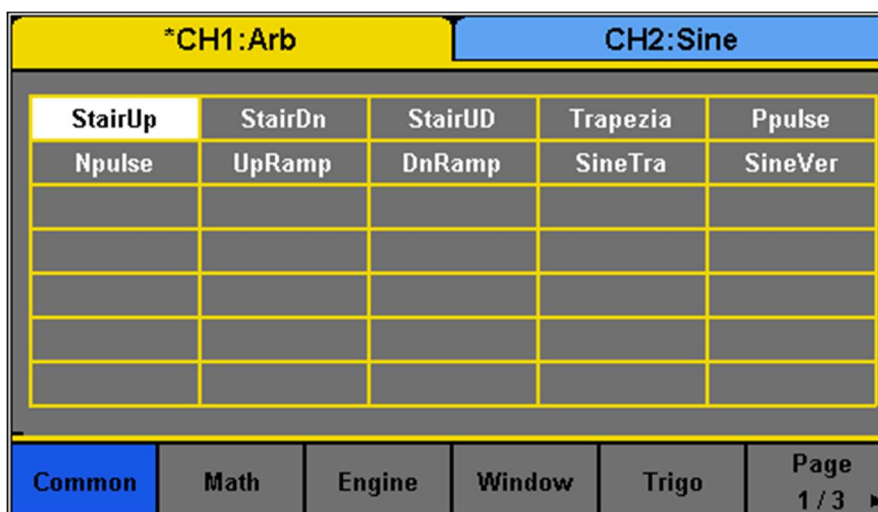

Figure 23 - Built-in Waveforms

- Once selected, press the knob to confirm and set the waveform or navigate to page 3/3 and press the **Accept** option from the menu.
- The generator will return to the main Arb parameter menu and the waveform display area will show the waveform shape of the selected predefined arbitrary waveform. For example, the screenshot below shows the display of the predefined **StairUp** signal.

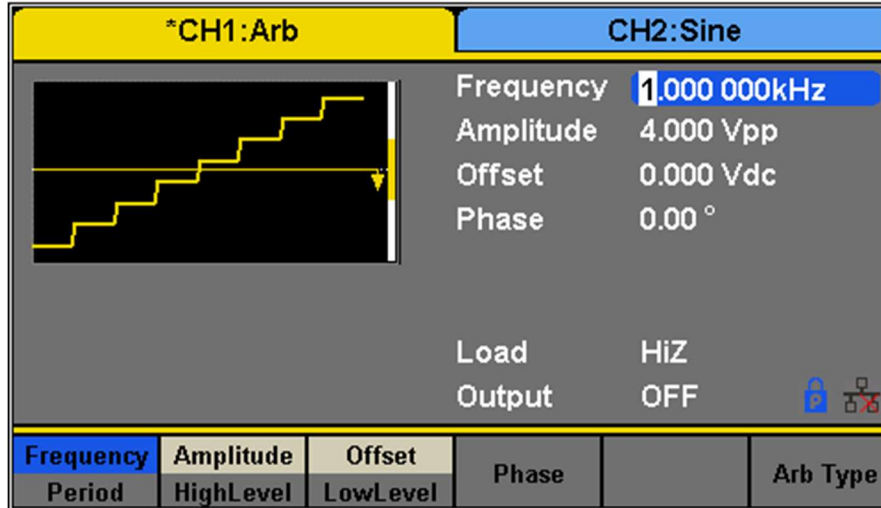

Figure 24 - Configuring an Arbitrary Waveform

- Adjust frequency, amplitude, and other parameters as desired.

### Generate User-Defined Waveforms

The generator has approximately 100MB of non-volatile memory that can store more than 1,000 user-defined arbitrary waveforms. Each stored waveforms have 16K pts (16384 pts) exactly.

---

**Note: The 100MB non-volatile memory is shared between storing/recalling user-defined arbitrary waveforms and instrument settings.**

---

To create an arbitrary waveform, users must use the USB interface in the rear panel for PC connectivity to the EasyWave software, which can be downloaded at [www.bkprecision.com](http://www.bkprecision.com).

---

**Note: EasyWave software supports Windows XP/Vista/7/8 (32 bit and 64 bit) only.**

---

EasyWave software will allow users to easily create a custom arbitrary waveform and load it into the internal memory.

To load a wave created from EasyWave to the internal memory of the unit or saved to a USB flash drive, follow the steps below:

1. Setup Press the **Waveforms** button.
2. Go to the second page of waveform options by pressing the **1/2▶** softkey. Select and press the **Arb** softkey from the menu.
3. Press **Arb Type** and select **Stored Waveforms** to see a list of all arbitrary waveform files created and loaded from EasyWave software.

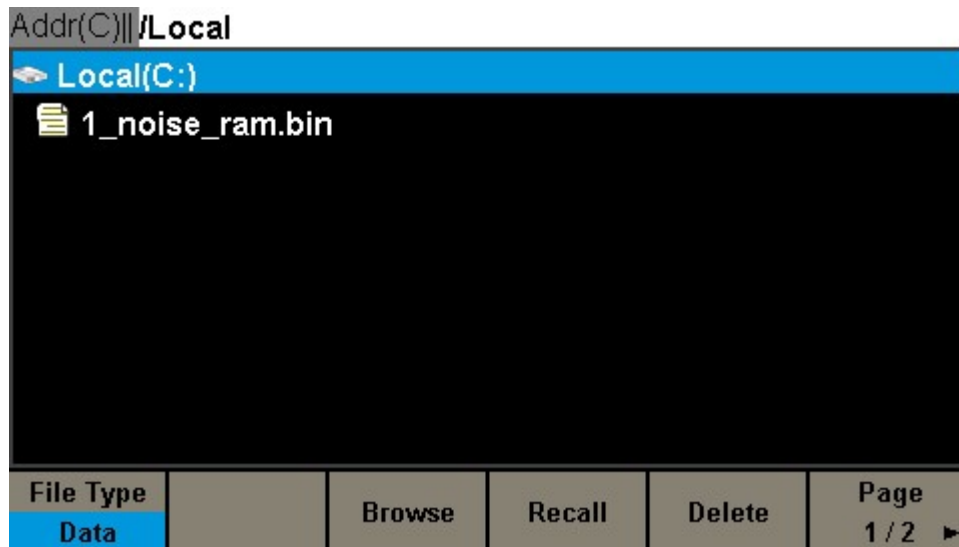

Figure 25 - User-Defined Arbitrary Waveform

4. Rotate the knob to choose the desired waveform. Then select **Recall** or press the knob to recall the corresponding waveform.
5. If the wave is located in a USB flash drive, the user will have to select the external memory drive from the menu above, as shown in the following picture:



Figure 26- Load an Arb Waveform from External USB

6. Use the knob to navigate to the file and either press the **Recall** softkey or press the knob to load the waveform.  
If the waveform is sent to the unit using EasyWave, the file will be saved to the internal memory. If it is loaded to a USB flash drive, then the waveform can be recalled from the USB flash drive.

### **Configure Harmonic Generator**

Configure the built-in harmonic generator to output harmonics with a specified order, amplitude and phase. This feature follows the Fourier series, as explained below.

According to the Fourier series, a periodic time domain waveform is the superposition of a series of sine waveforms as shown in the equation below:

$$f(t) = A_1 \sin(2\pi f_1 t + \phi_1) + A_2 \sin(2\pi f_2 t + \phi_2) + A_3 \sin(2\pi f_3 t + \phi_3) + \dots$$

Generally, the component with  $f_1$  is called the fundamental frequency.  $A_1$  is the fundamental waveform's amplitude and  $\phi_1$  is the fundamental waveform phase. The frequencies of the other components (called harmonics) are all integer multiples of the fundamental frequency. Components whose frequencies are odd multiples of the fundamental waveform frequency are called odd harmonics and components whose frequencies are even multiples of the fundamental waveform frequency are called even harmonics.

To select and configure the Harmonics Generator, follow the steps below:

1. Press **Waveforms** button.
2. Press **Sine** softkey.
3. Press the **Harmonic** softkey to toggle the function on or off.
4. If the "On" option is pressed, then the **Harmonic Parameter** softkey will be available.
5. Press **Harmonic Parameter** to enter the following screen.



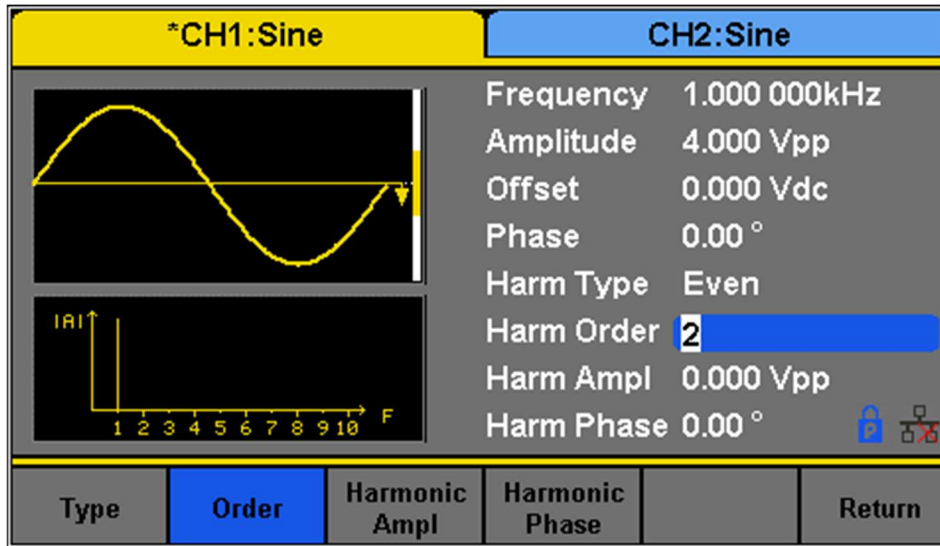

Figure 27 - Harmonic Generator

Item Menu	Function
Type	Set the harmonic type to “odd”, “even” or “all”.
Order	Set the order of the harmonic.
Harmonic Ampl	Set the amplitude of the harmonic.
Harmonic Phase	Set the phase of the harmonic.
Return	Return to the sine parameters menu.

Table 6 - Harmonics Generator Menu

### To Select the Harmonic Type

The 4050B can output odd harmonics, even harmonics and user-defined orders of harmonics.

1. Press **TYPE TO SELECT THE DESIRED HARMONIC TYPE**.
2. Press **Even**, and the instrument will output fundamental waveform and even harmonics.
3. Press **Odd**, and the instrument will output fundamental waveform and odd harmonics.
4. Press **All**, and the instrument will output the fundamental waveform and all the user-defined orders of harmonics.

### To Set the Harmonic Order

1. Press **Order**.
  - The range is limited by the maximum output frequency of the instrument and current fundamental waveform frequency.
  - Range: 2 to maximum output frequency of the instrument ÷ current fundamental waveform frequency
  - The maximum is 10.
2. Use the numeric keyboard or knob to input the desired value.
  - When the knob is used, the changes to the “Harm Order” will be immediate.
  - When the numeric keypad is used, after entering the value, the **Accept** softkey should be pressed to enter the value.

### To Select the Harmonic Amplitude

1. Press **Order** to select the sequence number of the harmonic to be set. Press **Harmonic Ampl** to set the amplitude of the harmonic selected. The units available are Vpp, mVpp and dBc.
2. This process should be repeated for each harmonic.

### To Select the Harmonic Phase

After entering the harmonic setting menu, press **Harmonic Phase** to set the phase of each harmonic.

1. Press **Order** to select the sequence number of the harmonic to be set.
2. Press **Harmonic Phase** to set the phase of the harmonic selected. Use the arrow keys and knob to change the value. Alternatively, use the numeric keyboard to input the phase value and then select the unit  $^{\circ}$  (degrees).

This process should be repeated for each harmonic.

## 3.4 Configure Modulation Output

Use the **Mod** key to generate modulated waveforms. The generator can generate AM, FM, ASK, FSK, PSK, PM, PWM and DSB-AM modulated waveforms. Modulating parameters vary with the types of the modulation.

Modulation Type	Parameter Settings
-----------------	--------------------

AM	source (internal/external), depth, modulating frequency, modulating waveform and carrier.
DSB-AM	source (internal/external), modulating frequency, modulating waveform and carrier
FM	source (internal/external), modulating frequency, frequency deviation, modulating waveform and carrier
PM	source (internal/external), phase deviation, modulating frequency, modulating waveform and carrier
ASK	source (internal/external), key frequency and carrier
FSK	source (internal/external), key frequency, hop frequency and carrier
PSK	source (internal/external), key frequency, polarity and carrier
PWM	source (internal/external), modulating frequency, width/duty cycle deviation, modulating waveform and carrier

**Table 7 - Modulation Type**

---

**Note: Noise and DC waveforms cannot be modulated.**

---

## ***AM Modulation***

The modulated waveform consists of two parts: the carrier and the modulating waveform. In AM, the amplitude of the carrier varies proportionally with the instantaneous voltage of the modulating waveform.

Press **Mod** → **Type** → **AM**, the parameters of AM modulation are shown in Figure 28.

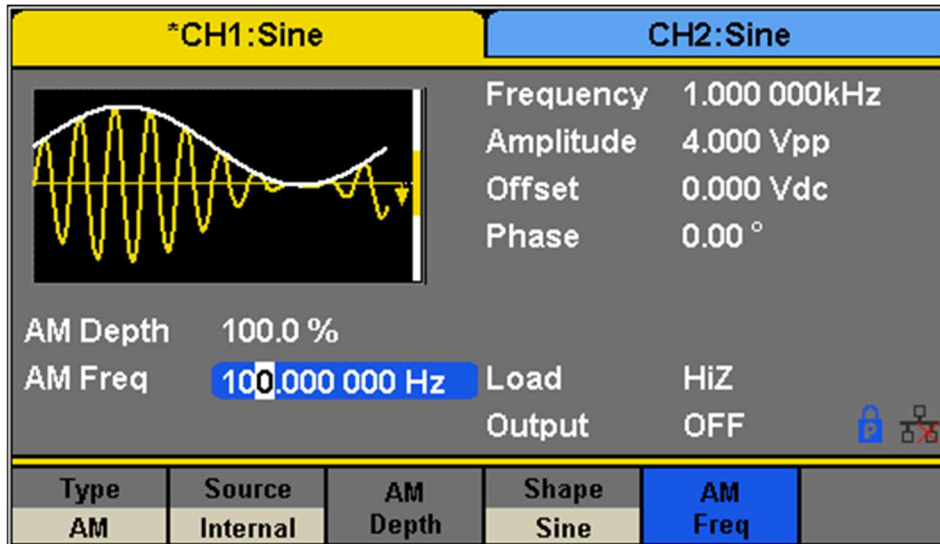

Figure 28 - Setting Interface of AM Modulation

Function Menu	Settings	Description
Type	AM	Amplitude modulation
Source	Internal	The source is internal
	External	The source is external. Use the [Aux In/Out] connector at the rear panel.
AM Depth		Set the modulation depth.
Shape	Sine	Choose the modulating waveform.
	Square	
	Triangle	
	UpRamp	
	DnRamp	
	Noise	
Arb		
AM Freq		Set the modulating waveform frequency. Frequency range: 1 mHz to 20 kHz (internal source only).

Table 8 - AM Modulation Menu Description

## Selecting Modulation Source

The generator can accept a modulating signal from an internal or external modulation source. Press **Mod** → **AM** → **Source** to select “Internal” or “External” modulation source. The default is “Internal”.

### Internal Source

When internal AM modulation source is selected, press **Shape** to select Sine, Square, Triangle, UpRamp, DnRamp, Noise or Arb as the modulating waveform.

- Square: 50% duty cycle
- Triangle: 50% symmetry
- UpRamp: 100% symmetry
- DnRamp: 0% symmetry
- Arb: the arbitrary waveform selected for the current channel

---

**Note:** Noise can be used as modulating waveform but cannot be used as the carrier.

---

### External Source

When external AM modulation source is selected, the generator accepts an external modulating signal from the [Aux In/Out] connector at the rear panel. At this time, the amplitude of the modulated waveform is controlled by the voltage applied to the connector. For example, if the modulation depth is set to 100%, the output amplitude will be the maximum when the modulating signal is +6V and the minimum when the modulating signal is -6V.



**Do not connect more than  $\pm 6$  V into the Modulation In terminal. This will damage the instrument and void its warranty.**

---

### Key Points:

The generator can use one channel as a modulating source for the other channel. The following example takes the output signal of CH2 as the modulating waveform.

1. Connect the CH2 output terminal to [Aux In/Out] connector on the rear panel using a BNC

cable.

2. Select CH1 and press **Mod** to select the desired modulation type as well as set the corresponding parameters, and then select external modulation source.
3. Select CH2 and select the desired modulating waveform and set the corresponding parameters.
4. Press **Output** to enable the output of CH1.

### To Set Modulation Depth

Modulation depth expressed as a percentage indicates the amplitude variation degree. AM modulation depth varies from 1% to 120%. Press **AM Depth** to set the parameter.

- For an external source, the depth of AM is controlled by the voltage level on the connector connected to the [Aux In/Out].  $\pm 6$  V correspond to 100% depth.
- When external modulation source is selected, this menu is hidden.

### To Set Modulation Frequency

When an internal modulation source is selected, press **AM Freq** to highlight the parameter, and then use the numeric keyboard or knob to input the desired value.

- The modulation frequency ranges from 1 mHz to 20 kHz.
- When an external modulation source is selected, this menu is hidden.

### ***DSB-AM Modulation***

DSB-AM is an abbreviation for Double-Sideband Suppressed Carrier – Amplitude Modulation. Press **Mod** → **Type** → **DSB-AM**. The parameters of DSB-AM modulation are shown in Figure 29.

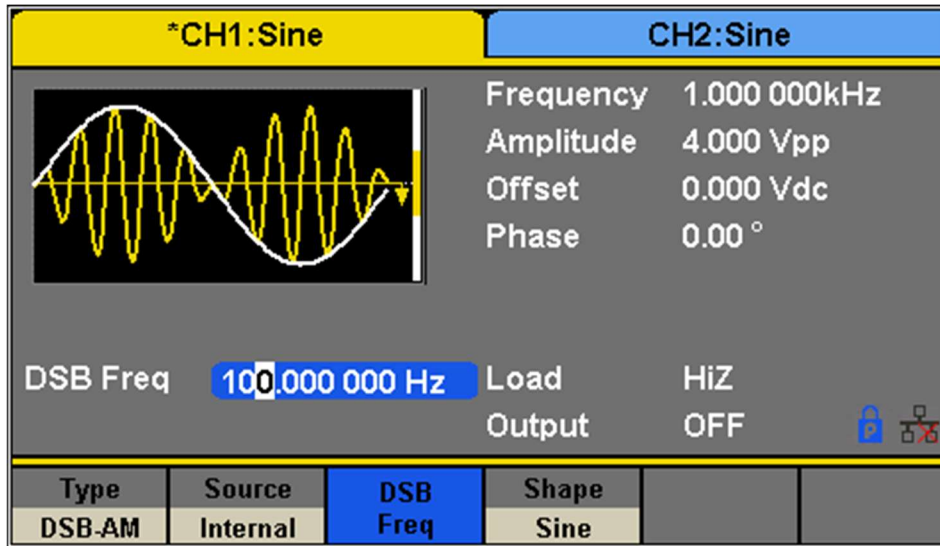

Figure 29 - Setting Interface of DSB-AM Modulation

Function Menu	Settings	Description
Type	DSB-AM	DSB Amplitude modulation.
Source	Internal	The source is internal.
	External	The source is external. Use the [Aux In/Out] connector at the rear panel.
DSB Freq		Set the modulating waveform frequency. Frequency range: 1 mHz to 20 kHz (internal source)
Shape	Sine	Choose the modulating waveform.
	Square	
	Triangle	
	UpRamp	
	DnRamp	
	Noise	
	Arb	

Table 9 - DSB-AM Modulation Menu Description

---

**Note:** The methods of setting the parameters of DSB-AM are similar to AM.

---

## FM Modulation

The modulated waveform consists of two parts: the carrier and the modulating waveform. In FM, the frequency of the carrier varies with the instantaneous voltage of the modulating waveform.

Press **Mod** → **Type** → **FM**; the parameters of FM modulation are shown in Figure 30.

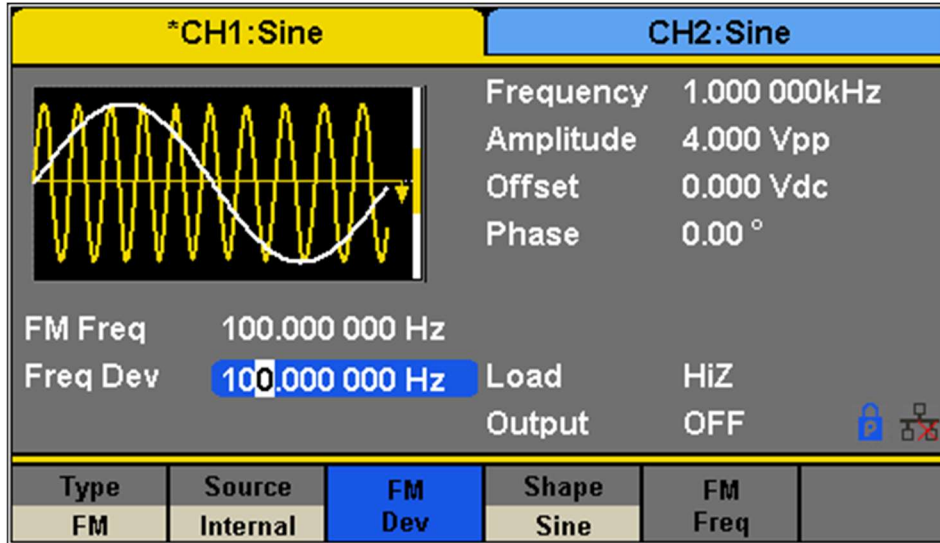

Figure 30 - Setting Interface of FM Modulation

Function Menu	Settings	Description
Type	FM	Frequency modulation
Source	Internal	The source is internal
	External	The source is external. Use the [Aux In/Out] connector at the rear panel.
Freq Dev		Set the frequency deviation
Shape	Sine	Choose the modulating waveform.
	Square	
	Triangle	
	UpRamp	
	DnRamp	
	Noise	
	Arb	



FM Freq		Set the modulating waveform frequency. Frequency range: 1 mHz to 20 kHz (internal source).
---------	--	---

Table 10 - FM Modulation Menu Description

### To Set Frequency Deviation

Press **FM Dev** to highlight the parameter and use the numeric keyboard or arrow keys and knob to input the desired value.

- The deviation should be equal to or less than the carrier frequency.
- The sum of the deviation and the carrier frequency should be equal to or less than maximum frequency of the selected carrier waveform.

---

**Note:** The methods of setting the parameters of FM are similar to AM.

---

### PM (Phase Modulation)

The modulated waveform consists of two parts: the carrier and the modulating waveform. In PM, the phase of the carrier varies with the instantaneous voltage level of the modulating waveform.

Press **Mod** → **Type** → **PM**; the parameters of PM modulation are shown in Figure 31.

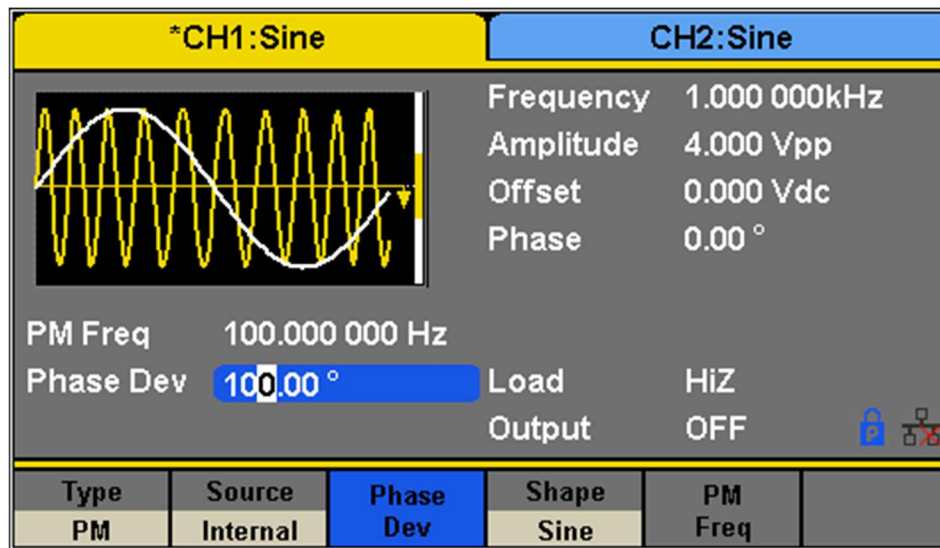

Figure 31 - Setting Interface of PM Modulation

Function Menu	Settings	Description
Type	PM	Phase modulation

<b>Source</b>	<i>Internal</i>	The source is internal
	<i>External</i>	The source is external. Use the [Aux In/Out] connector at the rear panel.
<b>Phase Dev</b>		Phase deviation ranges from 0° to 360°.
<b>Shape</b>	<i>Sine</i>	Choose the modulating waveform.
	<i>Square</i>	
	<i>Triangle</i>	
	<i>UpRamp</i>	
	<i>DnRamp</i>	
	<i>Noise</i>	
	<i>Arb</i>	
<b>PM Freq</b>		Set the modulating waveform frequency.

Table 11 - PM Modulation Menu Description

### To Set Phase Deviation

Press **Phase Dev** to highlight the parameter and use the numeric keyboard or arrow keys and knob to input the desired value.

The range of phase deviation is from 0° to 360° and the default value is 100°.

---

**Note: The methods of setting the parameters of FM are similar to AM.**

---

### ***FSK Modulation***

The FSK is Frequency Shift Keying, the output frequency switches between two preset frequencies (carrier frequency and the hop frequency or sometimes known as mark frequency (1) and space frequency (0)).

Press **Mod** → **Type** → **FSK**; the parameters of FSK modulation are shown in Figure 32.

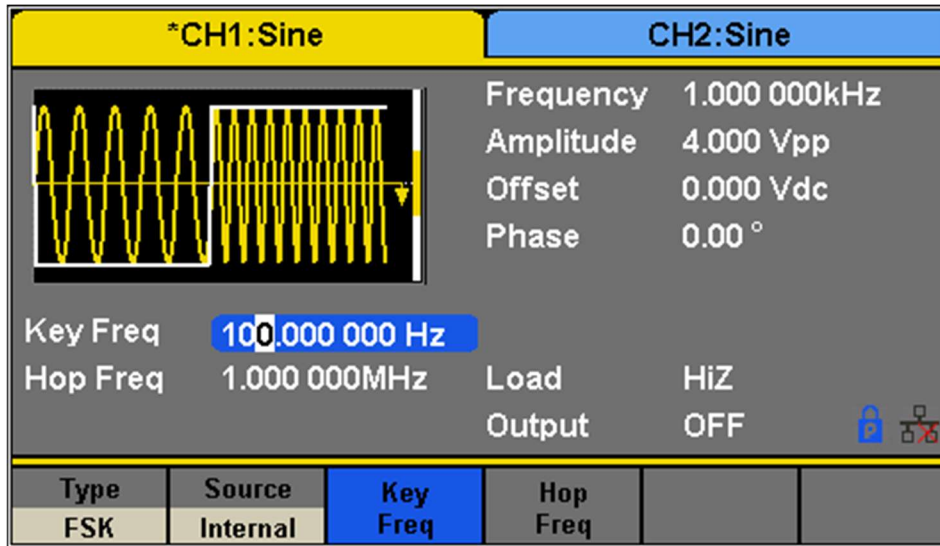

Figure 32 - Setting Interface of FSK Modulation

Function Menu	Settings	Description
<b>Type</b>	<i>FSK</i>	Frequency shift keying modulation
<b>Source</b>	<i>Internal</i>	The source is internal
	<i>External</i>	The source is external. Use the [Aux In/Out] connector at the rear panel.
<b>Key Freq</b>		Set the frequency at which the output frequency shifts between the carrier frequency and the hop frequency (internal modulation only): 1 mHz to 50 kHz.
<b>Hop Freq</b>		Set the hop frequency.

Table 12 - FSK Modulation Menu Dscription

### To Set Key Frequency

When internal modulation source is selected, press **Key Freq** to set the rate at which the output frequency shifts between “carrier frequency” and “hop frequency”.

- Use the numeric keyboard or knob to input the desired value.
- The key frequency ranges from 1 mHz to 50 kHz.
- When external modulation source is selected, this menu is hidden.

## To Set Hop Frequency

The range of the hop frequency depends on the carrier frequency currently selected. Press **Hop** **Freq** to highlight the parameter and use the numeric keyboard or knob to input the desired value.

- Sine: 1 uHz to max output depending on model.
- Square: 1 uHz to max output depending on model.
- Ramp: 1 uHz to 500 kHz
- Arb: 1 uHz to 6 MHz

---

**Note:** The methods of setting the parameters of FSK are similar to AM.

---

## ASK Modulation

When using ASK (Amplitude Shift Keying), the carrier frequency and key frequency will need to be set. The key frequency is the shift rate of the modulated waveform amplitude.

Press **Mod** → **Type** → **ASK**; the parameters of ASK modulation are shown in Figure 33.

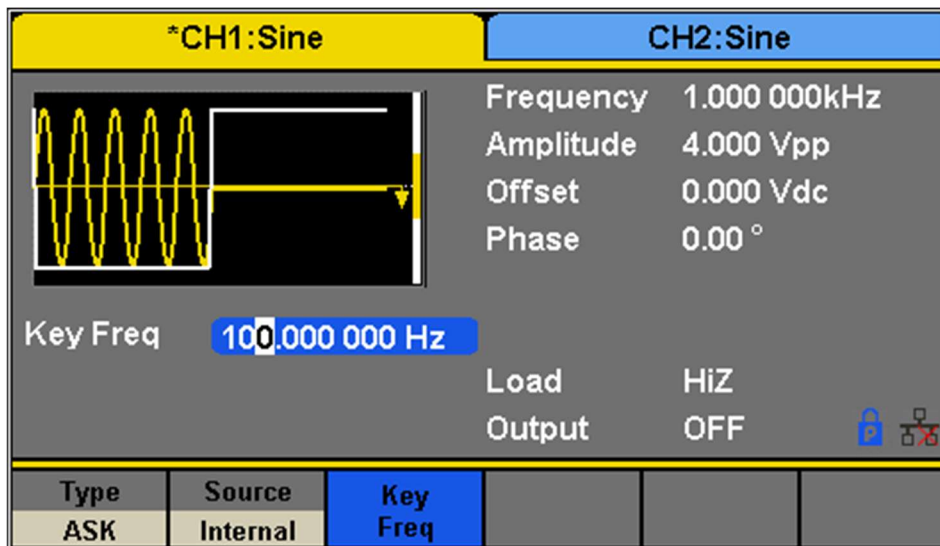

Figure 33 - Setting Interface of ASK Modulation

Function Menu	Settings	Description

<b>Type</b>	ASK	Amplitude shift keying modulation
<b>Source</b>	Internal	The source is internal
	External	The source is external. Use the [Aux In/Out] connector at the rear panel.
<b>Key Freq</b>		Set the frequency at which the output amplitude shifts between the carrier amplitude and zero (internal modulation only): 1 mHz to 50 kHz.

Table 13 - Table 13 - ASK Modulation Menu  
Description

Note: The methods of setting the parameters of ASK are similar to AM.

### PSK Modulation

When using PSK (Phase Shift Keying), configure the generator to “shift” its output phase between two preset phase values (carrier phase and modulating phase). The default modulating phase is 180°.

Press **Mod** → **Type** → **PSK**; the parameters of PSK modulation are shown in Figure 34.

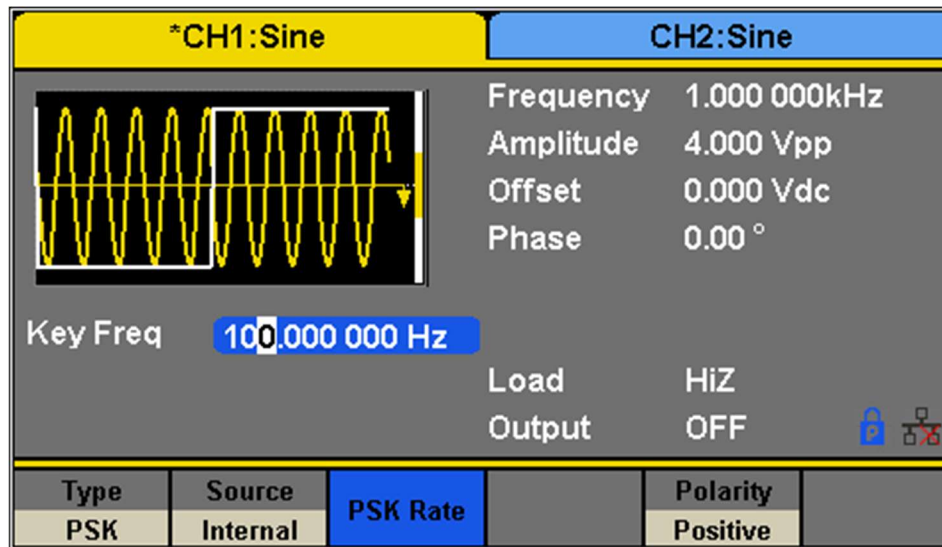

Figure 34 - Setting Interface of PSK Modulation

Function Menu	Settings	Description
<b>Type</b>	PSK	Phase shift keying modulation

<b>Source</b>	<i>Internal</i>	The source is internal
	<i>External</i>	The source is external. Use the [Aux In/Out] connector at the rear panel.
<b>Key Freq</b>		Set the frequency at which the output phase shifts between the carrier phase and 180° (internal modulation only): 1 mHz to 20 kHz.
<b>Polarity</b>	<i>Positive</i>	Set the modulating polarity
	Negative	

Table 14 - PSK Modulation Menu Description

---

**Note:** The methods of setting the parameters of PSK are similar to AM.

---

### **PWM (Pulse Width Modulation)**

In PWM (Pulse Width Modulation), the pulse width of the pulse varies with the instantaneous voltage of the modulating waveform. The carrier can only be a pulse waveform.

Press **Waveforms** → **Pulse** → **Mod** the parameters of PWM modulation are shown in Figure 35.

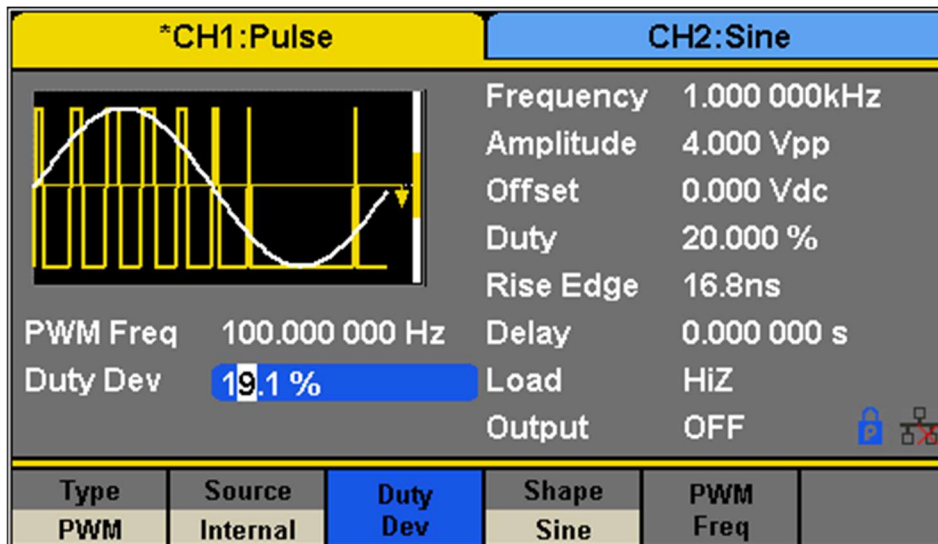

Figure 35 - Setting Interface of PWM Modulation

<b>Function Menu</b>	<b>Settings</b>	<b>Description</b>
<b>Type</b>	<i>PWM</i>	Pulse width modulation. The carrier is pulse.
<b>Source</b>	<i>Internal</i>	The source is internal
	<i>External</i>	The source is external. Use the [Aux In/Out] connector at the rear panel.
<b>Width Dev</b>		Set the width deviation.
<b>Duty Dev</b>		Set the duty deviation.
<b>Shape</b>	<i>Sine</i>	Choose the modulating waveform.
	<i>Square</i>	
	<i>Triangle</i>	
	<i>UpRamp</i>	
	<i>DnRamp</i>	
	<i>Noise</i>	
	<i>Arb</i>	
<b>PWM Freq</b>		Set the modulating waveform frequency. Frequency range: 1 mHz to 20 kHz (Internal source only).

**Table 15 - PWM Modulation Menu Description**

### **To Set Pulse Width/Duty Deviation**

Width Deviation represents the variation of the modulated waveform pulse width relative to the original pulse width. Press **Width Dev** to highlight the parameter, and use the numeric keyboard or knob to input the desired value as shown in the Figure 36.

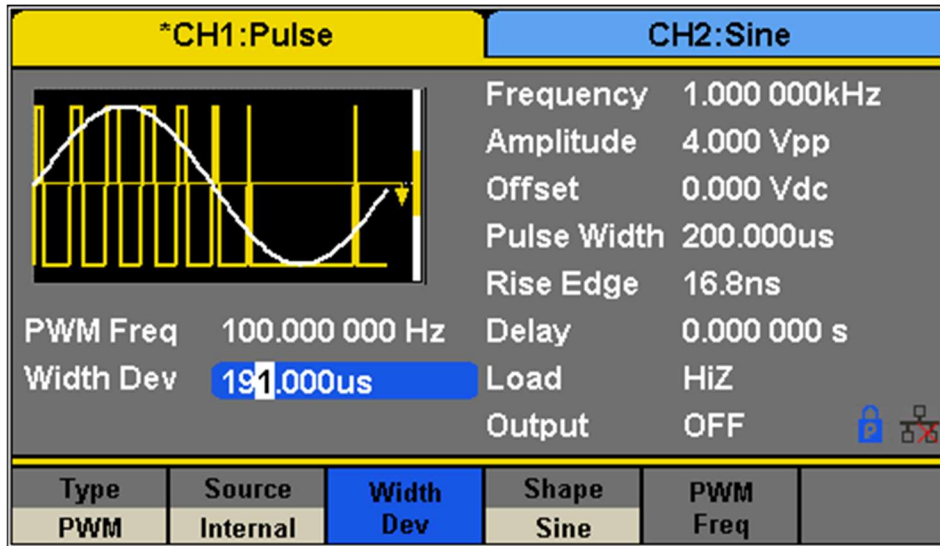

Figure 36 - Width Deviation Setting Interface

- The width deviation cannot exceed the current pulse width.
- The width deviation is limited by the minimum pulse width and current edge time setting.

Duty Deviation represents the variation (%) of the modulated waveform duty cycle relative to the original duty cycle. Press **Duty Dev** to highlight the parameter and use the numeric keyboard or knob to input the desired value as shown in the Figure 37.

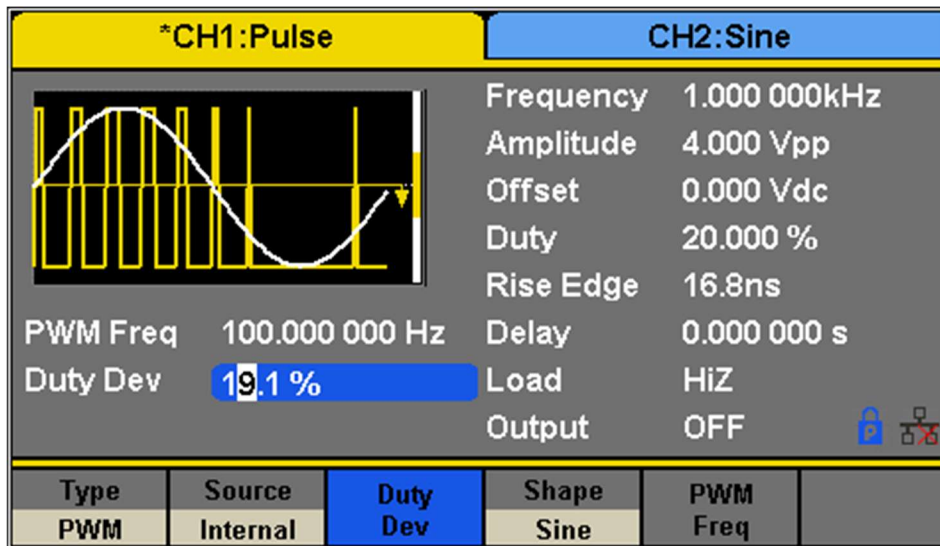

Figure 37 - Duty Deviation Setting Interface

- The duty deviation cannot exceed the current pulse duty cycle.
- The duty deviation is limited by the minimum duty cycle and current edge time setting.



- Duty deviation and width deviation are dependent. Once one parameter is changed, the other will be automatically changed.

---

**Note:** The methods of setting the parameters of PWM are similar to AM.

---

### 3.5 Configure Sweep Output

In the sweep mode, the generator steps from the start frequency to the stop frequency in the sweep time specified by the user. The waveforms that support sweep include sine, square, ramp and arbitrary.

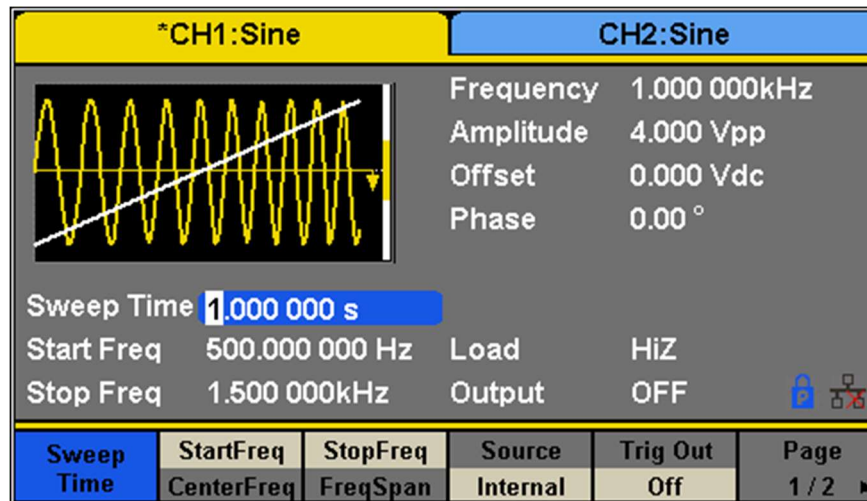

Figure 38 - Sweep Configuration

Function Menu	Description	
Sweep time	Set the time span of the sweep in which the frequency changes from the start frequency to stop.	
Start Freq/ Mid Freq	Set the start frequency of the sweep/ Set the center frequency of the sweep.	
Stop Freq Freq Span	Set the stop frequency of the sweep; Set the frequency span of the sweep.	
Source	Internal	Choose internal source as a trigger.
	External	Choose external source as a trigger. Use the [Aux In/Out] connector at the rear

	<i>Manual</i>	Trigger a sweep manually.
<b>Trig Out</b>	<i>Off</i>	Disable trigger out.
	<i>On</i>	Enable trigger out.
<b>Type</b>	<i>Linear</i>	Set the sweep with linear profile.
	<i>Log</i>	Set the sweep with logarithmic profile.
<b>Direction</b>	<i>Up</i>	Sweep upward.
	<i>Down</i>	Sweep downward.

**Table 16 - Sweep Function**

To select and configure the Sweep Function, follow the steps below:

1. Press the **Sweep** button.

### ***Sweep time***

2. Enter the **Sweep Time** using the keypad or knob.

### ***Sweep Frequency***

3. Press Start Freq and Stop Freq softkeys or Center Freq and Freq Span softkeys to set the range of the frequency sweep.

#### **a. Start Frequency and Stop Frequency**

Start Frequency and Stop Frequency are the lower and upper limits of the frequency for sweep. The Start Frequency must be less than or equal to the Stop Frequency.

#### **b. Center Frequency and Frequency Span**

Center Frequency =  $(|Start\ Frequency + Stop\ Frequency|)/2$

Frequency Span = Stop Frequency – Start Frequency

4. Press the key again to switch between the two sweep range modes.

### ***Sweep Trigger Source***

5. Press the **Source** softkey.
6. A new window will open and three options are shown: The sweep trigger source can be internal, external or manual. The generator will generate a sweep output when a trigger signal is received.

### **Internal Trigger**

- a. Press the **Source** softkey.
- b. Press the **Internal** softkey to select an internal trigger.  
The generator outputs a continuous sweep waveform when internal trigger is selected. The default is “Internal”.

### External Trigger

- a. Press the **Source** softkey.
- b. Press the **External** softkey to select an external trigger.  
The generator uses the trigger signal input to the [Aux In/Out] connector at the rear panel. A sweep will be generated once a TTL pulse with specified polarity is sent. To set the CMOS pulse polarity refer to the **Direction** section at the end of this section.

### Manual Trigger

- a. Press the **Source** softkey.
- b. Press the **Manual** softkey.  
A sweep will be generated when the **Trigger** softkey is pressed.

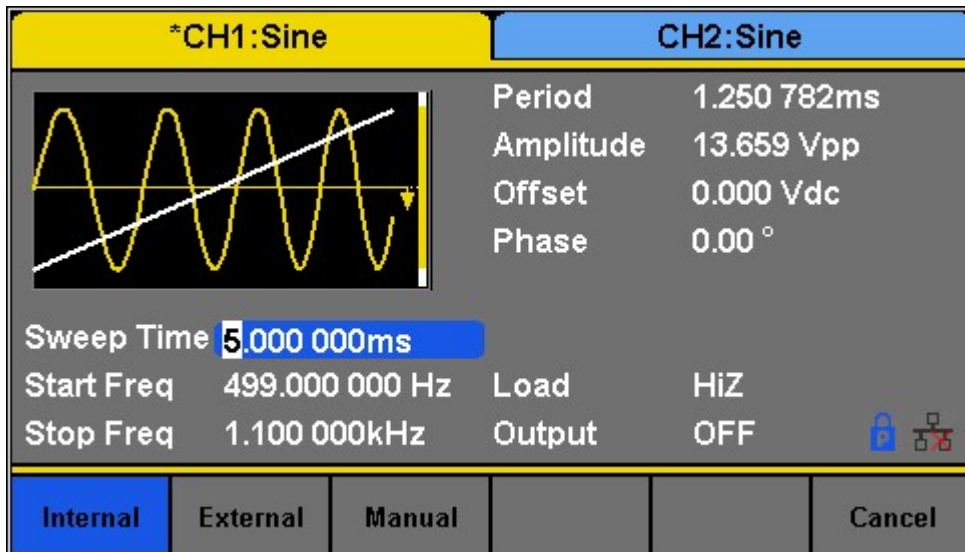

Figure 39 - Trigger Types

7. After selecting the type of trigger and pressing the softkey to select it, the user will exit the Trigger Source menu.

### Trig out

8. In the menu of the Sweep function, press **Trig Out**.
9. Toggle the softkey **On** and the [Aux In/Out] connector at the rear panel will output the trigger signal.

## Sweep Type

10. In the Sweep Function menu, press the **Page 1/2** ► softkey to access the second page of Sweep Options. “Linear” and “Log” sweep types are supported. The default type is “Linear”.

### A. LINEAR SWEEP

In linear sweep, the output frequency of the instrument varies linearly with the sweep time.

- Press the **Linear** softkey. A straight line is displayed on the waveform indicating that the output frequency will vary linearly.

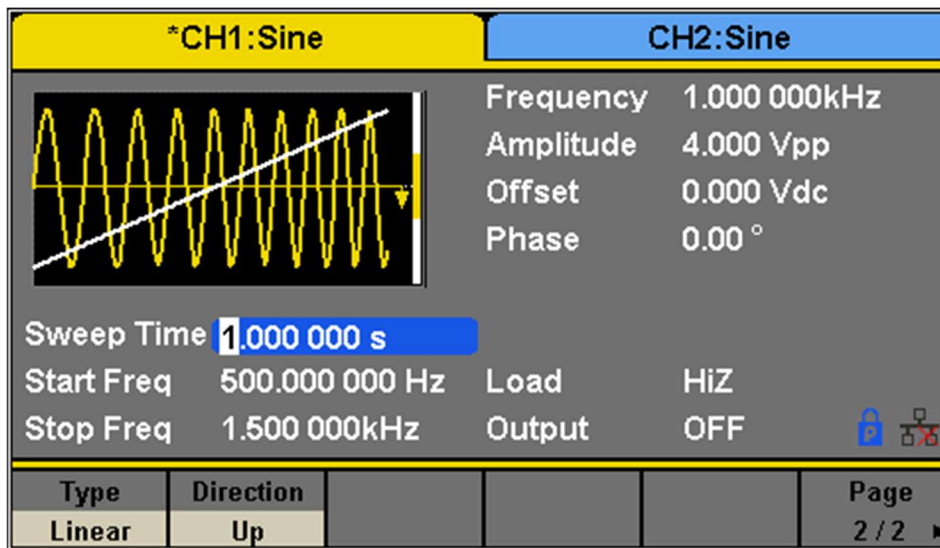

Figure 40 - Linear Sweep Interface

### B. LOG SWEEP

In log sweep, the output frequency of the instrument varies proportionally to the logarithm of the sweep time.

- Press the **Log** softkey.  
An exponential curve is displayed on the waveform indicating that the output frequency changes logarithmically.

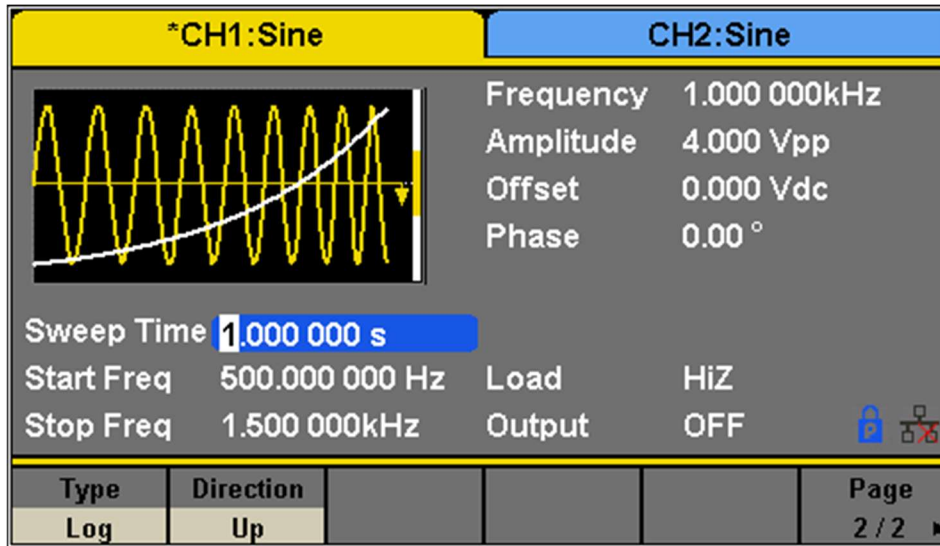

Figure 41 - Log Sweep Interface

### Direction

1. In the Sweep Function menu, press the **Page 1/2 ▶** softkey to access the second page of Sweep Options.
2. Press the **Direction** softkey to toggle between the two options: Up and Down.
  - **Up**: the generator will sweep from the Start frequency to the Stop frequency.
  - **Down**: the generator will sweep from the Stop frequency to the Start frequency.

---

**Note:** Sweep function is only available for sine, square, ramp, and arbitrary waveforms. It is not available for pulse, noise, or DC waveforms.

---

## 3.6 Configure Burst

The Burst function allows a specified number of periods of a waveform to be output (N-Cycle mode) or the waveform can be gated by an external signal (Gated mode). Any waveform except DC may be used as the carrier, with the limitation on the noise waveform in which only gated burst function is supported.

---

**Note:** Sweep function cannot operate when in burst mode.

---

**Note:** Gated burst operation is for use with an internal or external source only.

---

## Burst Type

The 4050B provides three burst types: N-Cycle, Infinite and Gated. The default is N-Cycle.

Burst Type, Trigger Source and Waveform

**Table 17 - Burst Type: Trigger Source and Waveforms**

<b>Burst Type</b>	<b>Trigger Source</b>	<b>Waveforms</b>
<i>N-Cycle</i>	<i>Internal/External/Manual</i>	Sine, Square, Ramp, Pulse, Arbitrary.
<i>Infinite</i>	<i>External/Manual</i>	Sine, Square, Ramp, Pulse, Arbitrary.
<i>Gated</i>	<i>Internal/External</i>	Sine, Square, Ramp, Pulse, Noise,

## N-Cycle

Waveforms that support N-Cycle burst include sine, square, ramp, pulse and arbitrary. Set the number of waveform cycles in an N-Cycle burst (1 to 50,000 or Infinite).

If Infinite is chosen, then a continuous waveform will be generated once a trigger occurs.

**Table 18 - NCycle Burst Menu**

<i>Item</i>	<b>Description</b>	
<i>NCycle</i>	Use the N-Cycle mode.	
<i>Cycles</i>	Set the number of the bursts in N-Cycle.	
<i>Infinite</i>	Set the number of the bursts in N-Cycle to be infinite.	
<i>Start Phase</i>	Set the start phase of the burst.	
<i>Source</i>	Internal	Choose internal source as a trigger. (Not available for Infinite Burst).
	External	Choose external source as a trigger. Use the [Aux In/Out] connector at the rear panel.
	Manual	Trigger a burst with manual trigger.
<i>Delay</i>	Set the delay time before the burst	
	Off	Disable trigger out.

Trig Out	On	Enable trigger out.
----------	----	---------------------

## Cycles

In N-Cycle mode, the generator will output a specified number N of waveform cycles (periods) after receiving the trigger signal.

To configure Burst Cycles, follow these instructions:

1. Press the **Burst** button.
2. Press the **NCycle** softkey.
3. Press the **Cycles** softkey.
4. Use the numeric keyboard or knob to input the desired number of cycles.

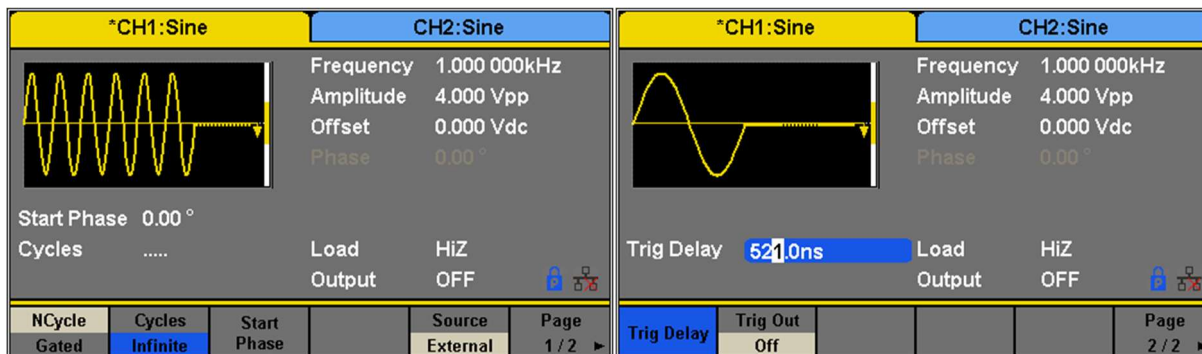

Figure 42 – Burst NCycle

## Infinite

In infinite mode, the cycle number of the waveform is set as an infinite value. The generator outputs a continuous waveform after receiving the trigger signal. Waveforms that support infinite mode include sine, square, ramp, pulse and arbitrary.

To configure Burst Infinite Cycles, follow the steps below:

1. Press the **Burst** button.
2. Press the **NCycle** softkey.
3. Press the **Infinite** softkey.
4. Set the trigger source to either **External** or **Manual** (Internal trigger source is not available when Burst NCycle is set to Infinite).

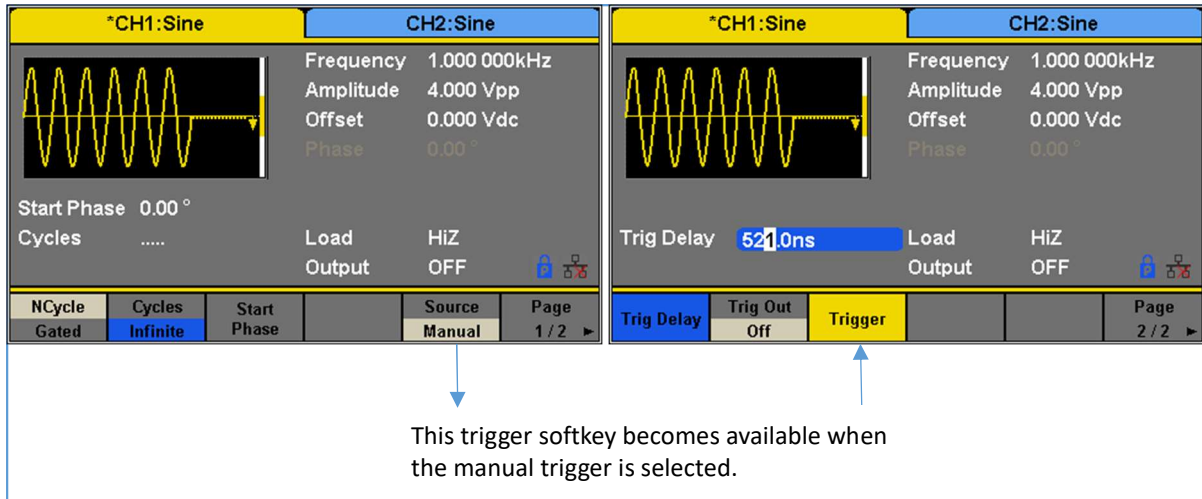

Figure 43 – NCycle Burst Manual Trigger

### Gated

In gated mode, the generator controls the waveform output according to the gated signal level. When the gated signal is ON, the generator outputs a continuous waveform. When the gated signal is OFF, the generator first completes the output of the current period and then stops. Waveforms that support gated burst include sine, square, ramp, pulse, noise and arbitrary.

Item	Description	
<b>Polarity</b>	Positive	Set the polarity for the gated signal.
	Negative	
<b>Start Phase</b>	Set the start phase of the burst.	
<b>Burst Period</b>	Set the burst Period.	
<b>Source</b>	Internal	Choose internal source as a trigger.
	External	Choose external source as a trigger. Use the [Aux In/Out] connector at the rear panel.

Table 19 - Gated Burst



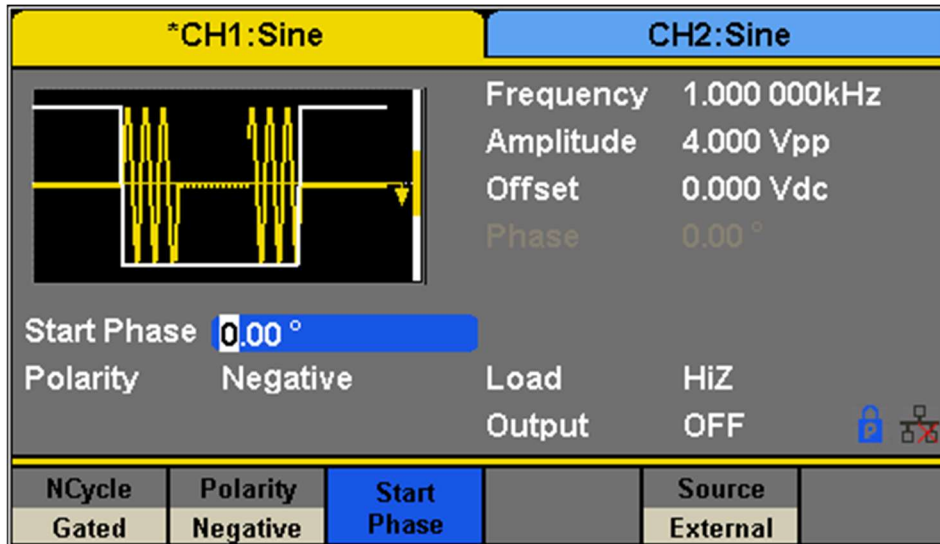

Figure 44 - Negative Gated Burst

To configure Burst Gated, follow the steps below:

1. Press the **Burst** button.
2. Press the **Gated** softkey.
3. Select a Polarity for the gate. This determines whether the gate will go from low to high (positive gate) or from high to low (negative gate).

### ***Common Settings for NCycle and Gated Burst:***

#### **Start Phase**

Define the start point in a waveform. The phase varies from 0° to 360° and the default is 0°. For an Arbitrary Waveform, 0° is the first waveform point.

#### **Burst Period**

Burst Period is only available when the trigger source is internal. It is defined as the time from the start of a burst to the start of the next one. Choose **Burst Period** and use the numeric keyboard or knob to input the desired value.

- Burst Period  $\geq 0.99 \mu\text{s} + \text{carrier period} \times \text{burst number}$
- If the current burst period set is too short, the generator will increase this value automatically to allow outputting the specified number of cycles.

#### **Trig Delay**

Set the time delay between the trigger input and the start of the N-Cycle burst.

## Burst Trigger Source

The burst trigger source can be internal, external or manual. The generator will generate a burst output when a trigger signal is received and wait for the next trigger source.

To configure the Trigger Source, once in the Burst menu:

### Internal Trigger

1. Press the **Source** softkey.
2. Press the **Internal** softkey.
3. The generator outputs a continuous burst waveform when internal trigger is selected.
4. Go to the second page of this menu, press **Trig Out** and select "Up" or "Down" and the [Aux In/Out] connector at the rear panel will output a trigger signal with specified edge or set it "Off" to not output a signal from the [Aux In/Out].

### External Trigger

1. Press the **Source** softkey.
2. Press the **External** softkey.
3. The generator accepts the trigger signal input from the [Aux In/Out] connector at the rear panel when external trigger is selected. A burst will be generated on a CMOS pulse with specified polarity. To set the CMOS pulse polarity go to the second page of this menu, and press **Edge** and select "Up" or "Down".

### Manual Trigger

1. Press the **Source** softkey.
2. Press the **External** softkey.
3. Press the **Trigger** softkey to generate a burst.

## 4 Utility Functions

The utility menu can be accessed by pressing the **Utility** button from the front panel. This section describes all the configurable settings of this menu.

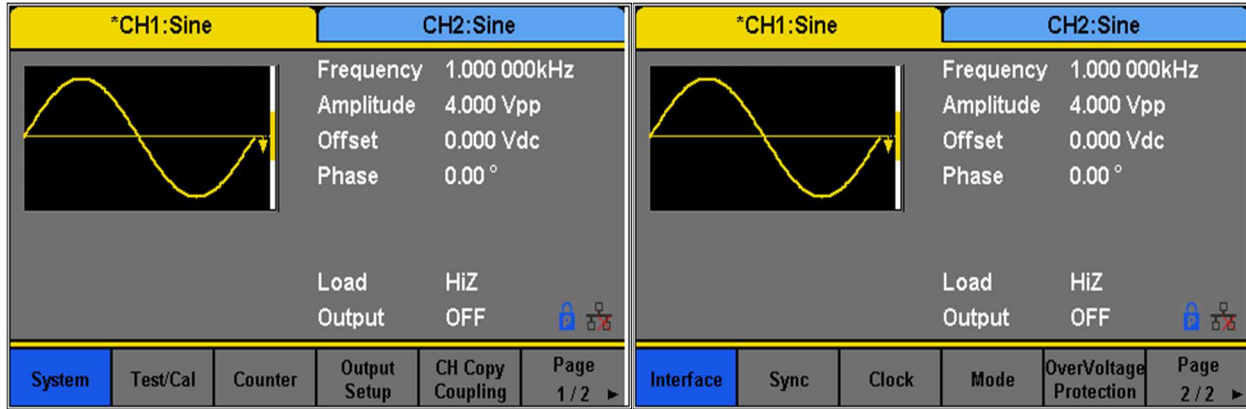

Figure 45 - Utility Menu

Item	Description	
<b>System</b>	Set the system configuration.	
<b>Test/Cal</b>	Test and calibrate the instrument.	
<b>Counter</b>	Frequency counter settings.	
<b>Output Setup</b>	Set the output parameters of CH1 and CH2.	
<b>CH Copy Coupling</b>	Set the track, channel coupling or channel copy function.	
<b>Interface</b>	Set the parameters of remote interfaces.	
<b>Sync</b>	Set the sync output.	
<b>CLKSource</b>	<b>Internal</b>	Choose the system clock source.
	<b>External</b>	
<b>Mode</b>	Choose Phase-locked or independent mode.	
<b>OverVoltage Protection</b>	Turn on/off the overvoltage protection function.	

Table 20 - Utility Menu

## 4.1 System Settings

1. Press the **Utility** button.
2. Press the **System** softkey to enter the system options:

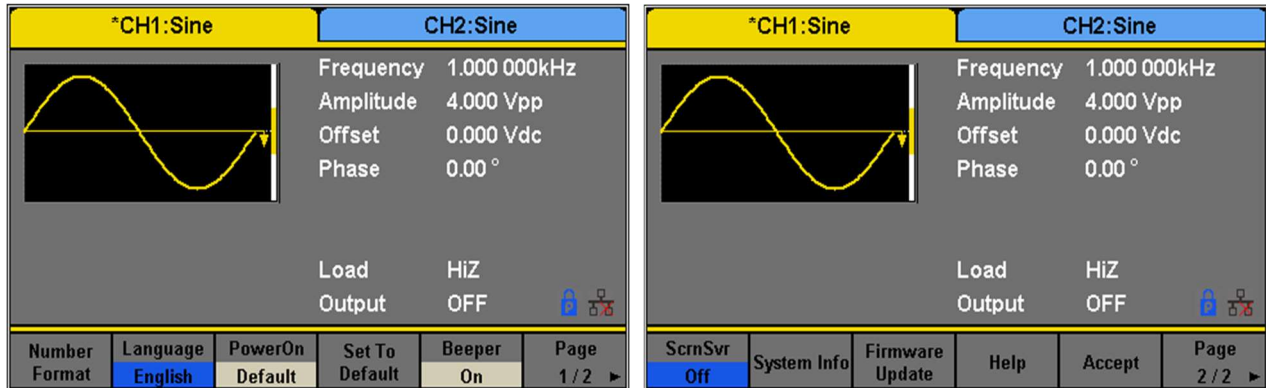

Figure 46 - System Options

Item	Description	
<b>Number format</b>	Set the numerical format.	
<b>Language</b>	<b>English</b>	Set the language.
	<b>Chinese</b>	
<b>PowerOn</b>	<b>Default</b>	All the settings return to their defaults at power on.
	<b>Last</b>	All the settings return to the settings at the last power down.
<b>Set to Default</b>	Set all the settings to their defaults.	
<b>Beeper</b>	<b>On</b>	Turn on the key sound (beep).
	<b>Off</b>	Turn off the key sound (beep).
<b>ScrnSvr (Screensaver)</b>	<b>1min</b>	Enable screensaver for the specified amount.
	<b>5min</b>	
	<b>15min</b>	
	<b>30min</b>	

	<b>1hour</b>	
	<b>2hour</b>	
	<b>5hour</b>	
	<b>Off</b>	Disables screensaver.
<b>System Info</b>	View system information	
<b>Firmware Update</b>	Update firmware using a USB flash drive.	
<b>Help</b>	View the help information.	
<b>Accept</b>	Save the current settings and return to the Utility menu.	

Figure 47 - System Settings

### Numerical Format

To change the numerical format of the generator, follow these instructions:

- a. Press the **Utility** button.
- b. Press the **System** softkey.
- c. Press the **Number Format** softkey.

The options for the Numerical Format are shown in Table 21 - Numerical Format

Item	Description	
<b>Point</b>	.	Use a dot to represent the decimal point;
	,	Use a comma to represent the decimal point.
<b>Separator</b>	On	Enable the Separator.
	Off	Disable the Separator.
	Space	Use Space as the separator.
<b>Accept</b>	Save the current settings and return to the System menu.	

Table 21 - Numerical Format

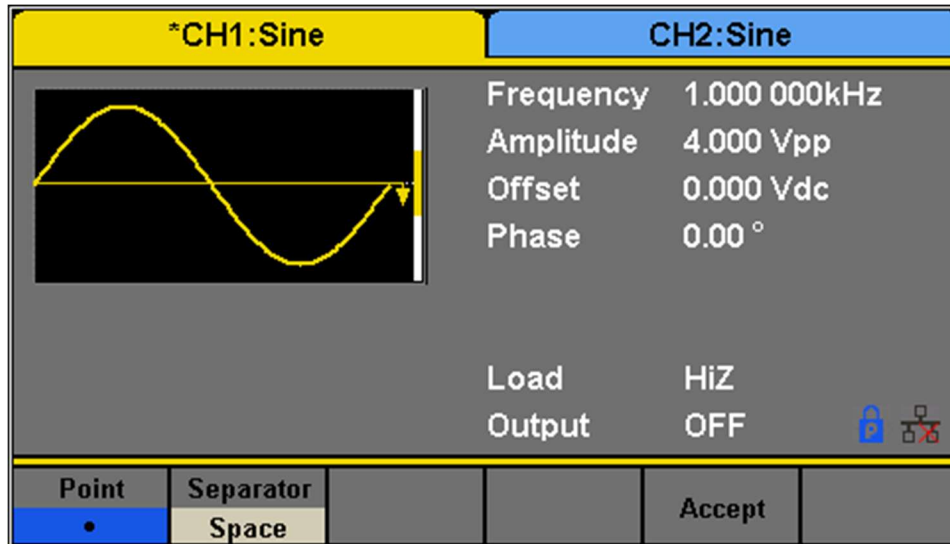

Figure 48 - Numerical Format Options

### Language Setup

The generator offers two languages (English and Simplified Chinese).

- Press the **Utility** button.
- Press the **System** softkey.
- Press the **Language** softkey to select the desired language.

### Power On

The 4050B series offers two options for power on settings: Last and Default. To set either option, follow these instructions:

- Press the **Utility** button
- Press the **System** softkey.
- Press the **PowerOn** softkey to toggle between the two options:
  - Default:** Denotes the factory defaults except certain parameters (such as Language).
  - Last:** Includes all system parameters and states set when the unit was last powered down, except channel output state. This setting is stored in non-volatile memory and will not be affected by the **Set To Default** operation.

## Set to Default

Sets the unit to defaults settings:

- Press the **Utility** button.
- Press the **System** softkey.
- Press the **Set to Default** to set the system to the default setting. The default settings of the system are:

Table 22 - Factory Default Settings

Setting	Default value
<b>Output</b>	
Function	Sine Wave
Frequency	1 kHz
Amplitude/Offset	4 Vpp/0 Vdc
Phase	0°
Load	High Z
<b>Modulation</b>	
Carrier	1 kHz Sine Wave
Modulating	100 Hz Sine Wave
AM Depth	100%
FM Deviation	100 Hz
ASK Key Frequency	100 Hz
FSK Key Frequency	100 Hz
FSK Hop Frequency	1 MHz
PSK Key Frequency	10 0Hz
PM Phase Deviation	100°
PWM Width Dev	190 μs
<b>Sweep</b>	
Start/Stop Frequency	500 Hz/1.5 kHz
Sweep Time	1 s
Trig Out	Off
Mode	Linear

Direction	↑
<b>Burst</b>	
Burst Period	10 ms
Start Phase	0°
Cycles	1 Cycle
Trig Out	Off
Delay	521 ns
<b>Trigger</b>	
Source	Internal

### ***Key Sound (Beeper)***

Turns the instrument key press sound ON or OFF. When off, this setting will also disable the sound for any errors that may occur during front panel or remote operation.

- a. Press the **Utility** button.
- b. Press the **System** softkey.
- c. Press the **Beeper** softkey to select “On” or “Off”. The default is “On”.

### ***Screen Saver***

This setting allows to enable or disable the screen saver.

- a. Press the **Utility** button.
- b. Press the **System** softkey.
- c. Press the **Page 1/2** to access the second page of options.
- d. Press the **ScrnSvr** softkey to select “On” or “Off”.

### ***System Info***

- a. Press the **Utility** button.
- b. Press the **System** softkey.
- c. Press the **Page 1/2** to access the second page of options.
- d. Press the **System Info** option to see the following screen.





Figure 49 - System Information Screen

## ***Firmware Update***

The software version and configuration file of the generator can be updated directly via USB flash drive. To update the firmware, follow the steps below:

- a. Insert USB flash drive with firmware update file (\*.ADS) and configuration file (\*.CFG) to USB host interface on the front panel of the generator.
- b. Press the **Utility** button.
- c. Press the **System** softkey.
- d. Press the **Page 1/2** to access the second page of options.
- e. Press the **Firmware Update** softkey. Or press **Store/Recall** directly.
- f. Select the firmware file (\*.ADS) and choose **Recall** to update the system software.
- g. After the updating is finished, the generator will restart automatically.
- h. Press **Utility** → **Page 1/2** → **Firmware Update**. Or press **Store/Recall** directly.
- i. Select the configuration file (\*.CFG) and choose **Recall** to update the configuration file.
- j. After the update completes, the generator will restart automatically.

---

### **⚠ WARNING**

Do not turn off the power while the generator's firmware is being updated.

---

**Note:** A configuration file (\*.CFG) may or may not be included with a given firmware update. If a CFG file is not included with a firmware update then it will not be required for that specific update.

---

## Built-in Help

The 4050B Series provides a built-in help system. There are 10 topics in the help list. Use the softkeys to navigate through the options and select a topic to read. To access the Built-in Help follow the below instructions:

- a. Press the **Utility** button.
- b. Press the **System** softkey.
- c. Press the **Page 1/2** to access the second page of options.
- d. Press the **Help** softkey to enter the following screen:

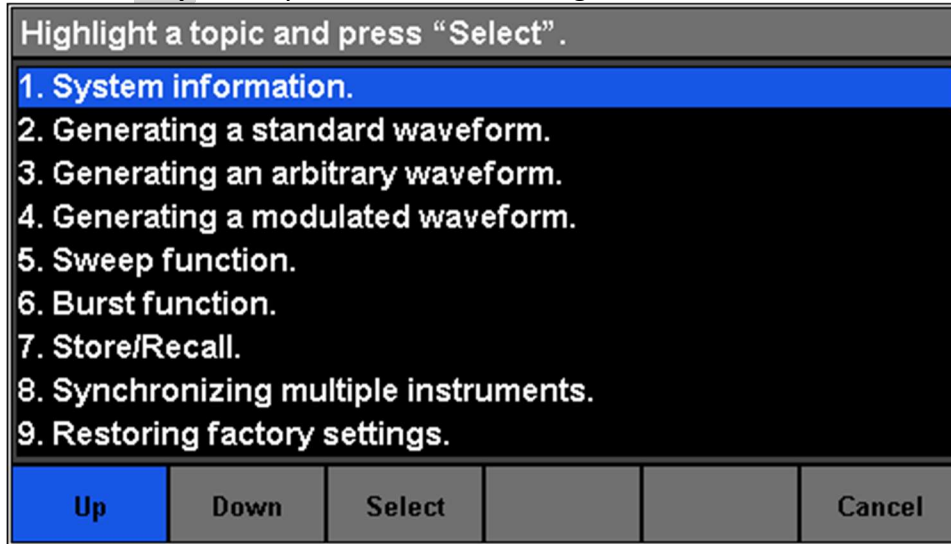

Figure 50 - Built-in Help Menu

Menu	Description
UP	Cursor upward to select.
Down	Cursor downward to select.
Select	Read the currently selected help information.
Cancel	Exit the built-in help system.

Figure 51 - Built-in Help

## 4.2 Test/Cal

This function allows the user to run self-diagnostics.

- a. Press the **Utility** button.
- b. Press the **Test/Cal** softkey. The following options will be available:

Item	Description
<b>ScrTest</b>	Run the screen test program.
<b>KeyTest</b>	Run the keyboard test program.
<b>LEDTest</b>	Run the key indicator lights test program.
<b>BoardTest</b>	Run the hardware circuit self-test program.
<b>Cancel</b>	Return to the Test/Cal menu.

Table 23 - Self Test Menu

- c. To enter any test, press the corresponding sotkey:

### **ScrTest**

- a. Press **ScrTest** to enter the screen test interface.
- b. The prompt message, "Please press '7' key to continue. press '8' key to exit." is displayed.
- c. Press the '7' key to test the display for color deviation, bad pixels or display errors.

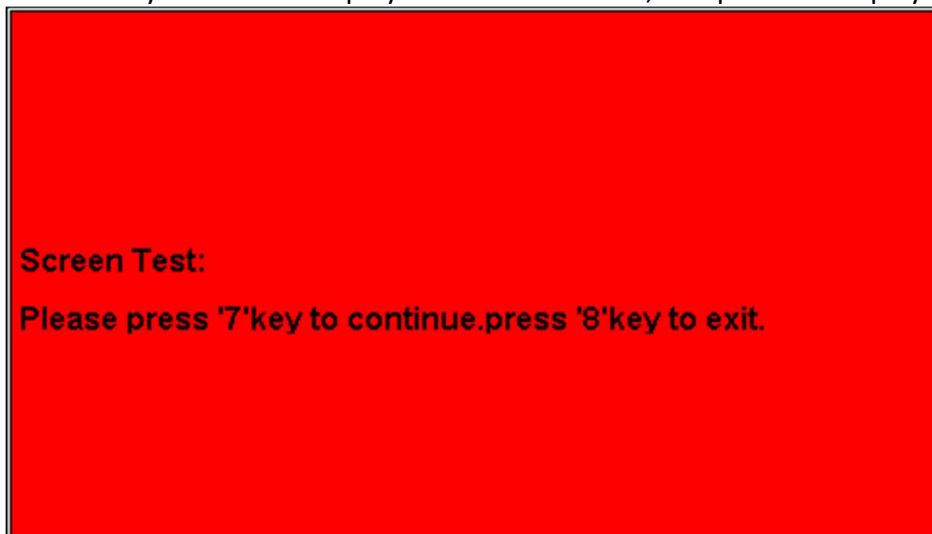

Figure 52 - Screen Test

## Key Test

- Press the **KeyTest** softkey to enter the key test interface.  
The on-screen white rectangle shapes represent the front panel keys. The circle between two arrows represents the knob.
- Test all keys by pressing them and knob by rotating it. Also verify that all the backlight keys illuminate correctly.

The items tested will change to blue.

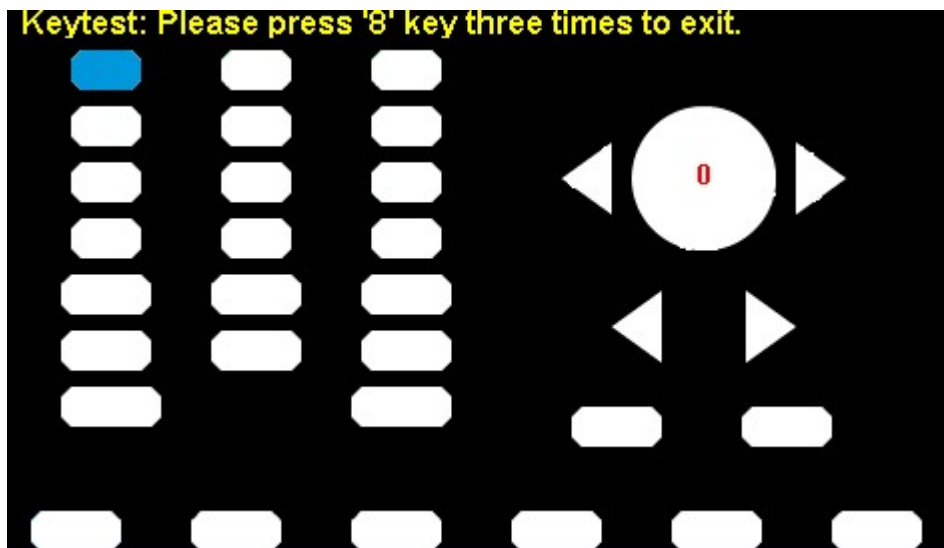

Figure 53 - Key Test

## LED Test

- Press the **LEDTest** softkey to enter the LED test interface.  
The on-screen white rectangle shapes represent the front panel keys. The prompt message, "Please press '7' Key to continue, press '8' Key to exit." is displayed.
- Press the '7' key continuously for testing the key backlights.

The items tested will change to blue.

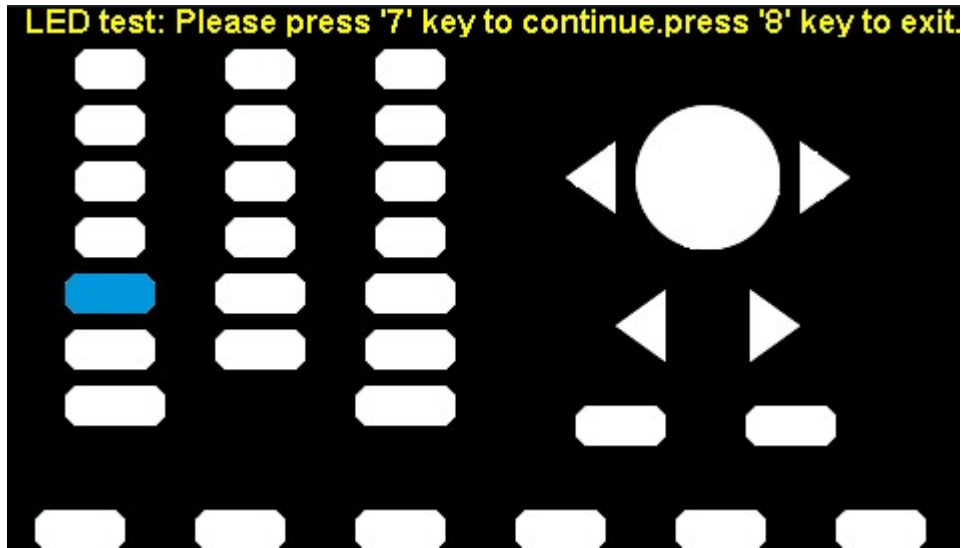

Figure 54 - LED Test

### Board Test

- a. Press the **BoardTest** softkey to test the internal hardware of the generator. It will indicate either "pass" or "fail".

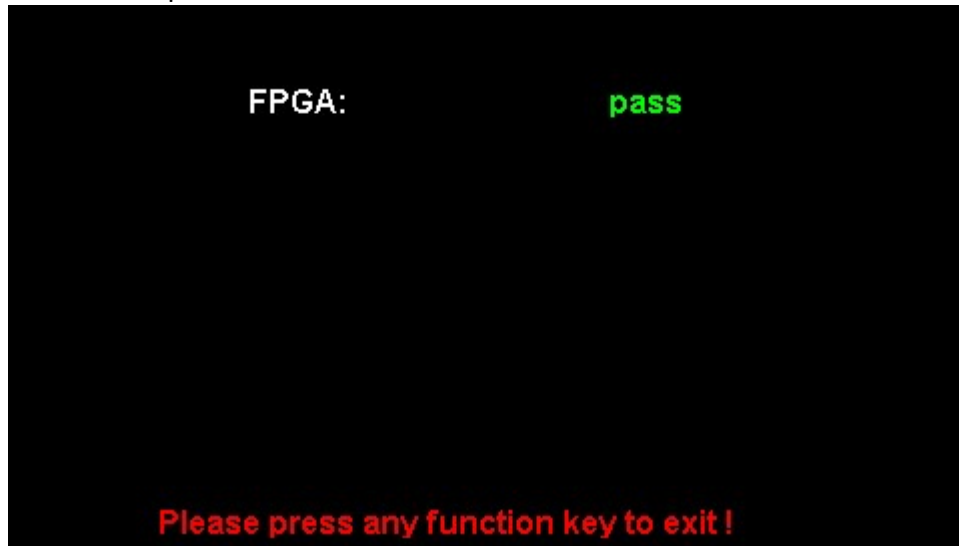

Figure 55 - Board Test

## 4.3 Frequency Counter

The generator has a built-in frequency counter that can measure frequencies between 100 mHz to 200 MHz (DC Coupling) and 10 Hz to 200 MHz (AC Coupling). This unit has a dedicated connector in the back panel for the frequency counter.

To configure the Frequency Counter follow the steps below:

- a. Press the **Utility** button.

b. Press the **Counter** softkey. The following options will be available:

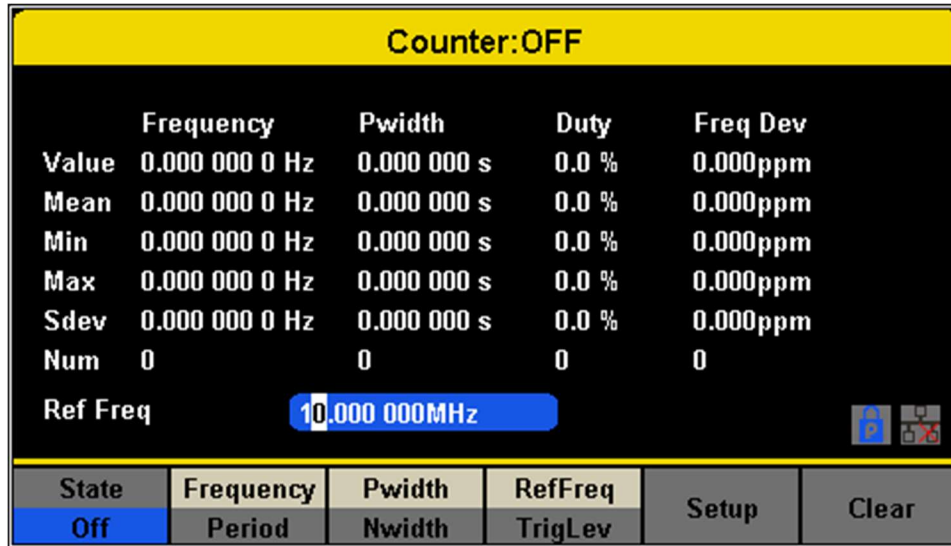

Figure 56 - Frequency Counter

Function Menu	Description	
<b>State</b>	<i>Off</i>	Turn the counter on.
	<i>On</i>	Turn the counter off.
<b>Frequency</b>	Measure frequency.	
<b>Period</b>	Measure period.	
<b>PWidth</b>	Measure positive width.	
<b>NWidth</b>	Measure negative width.	
<b>RefFreq</b>	Set the reference frequency. The instrument will display the deviation in parts per million (ppm) between the measured frequency and the reference frequency.	
<b>TrigLev</b>	Set the trigger level voltage.	
<b>Duty</b>	Measured duty cycle.	
<b>Setup</b>	Set the counter configuration.	
<b>Clear</b>	Clear the statistical data.	

Table 24 - Frequency Counter Function Description

- c. Press the **State On/Off** to enabled the counter.
- d. Select the parameter to be measured and press its respective softkey. The frequency counter can measure the below parameters:
- Frequency

- Period
  - Positive pulse width (Pwidth)
  - Negative pulse width (Nwidth)
- e. Press the RefFreq/TrigLevel to set the reference frequency or to set a trigger level:
- Reference Frequency:  
The counter will display the deviation in parts per million between the measured frequency and the reference frequency.
  - Trigger Level:  
Sets the trigger level of the measurement system. The counter triggers and displays the measurement readings when the input signal reaches the specified trigger level. The default is 0 V and the available range is from -3 V to 1.5 V. Choose **TrigLev** and use the numeric keyboard to input the desired value and select the unit (V or mV) from the pop-up menu. Alternatively, use the knob and arrow keys to change the parameter value.
- f. Press the **Setup** softkey to configure the coupling mode, high frequency rejection or set the configuration back to default.
- Coupling Mode  
Sets the coupling mode of the input signal to “AC” or “DC”. The default is “AC”.
  - HFR  
High Frequency Rejection can be used to filter out high-frequency components of a measured signal and improve the measurement accuracy in low-frequency signal measurement. Press HFR to enable or disable this function. The default is “Off”.
    - Enable High Frequency Rejection when 250 kHz or less signals are measured to filter out unwanted high-frequency interference.
    - Disable High Frequency Rejection when a signal with a frequency higher than 250 KHz is measured. The maximum frequency that can be counted is 200 MHz.

## 4.4 Output

The 4050B series has output settings that can be configured to either adjust the display to match the output of the unit to high impedance or 50  $\Omega$ , change the polarity of the output, and set the output phase to be the same for both channels

- a. Press the **Ch1/Ch2** button to toggle between channel 1 and channel 2 to configure respective output parameters of each channel.
- b. Press the **Utility** button.
- c. Press the **Output Setup** softkey. The Output options will be displayed on the next screen:

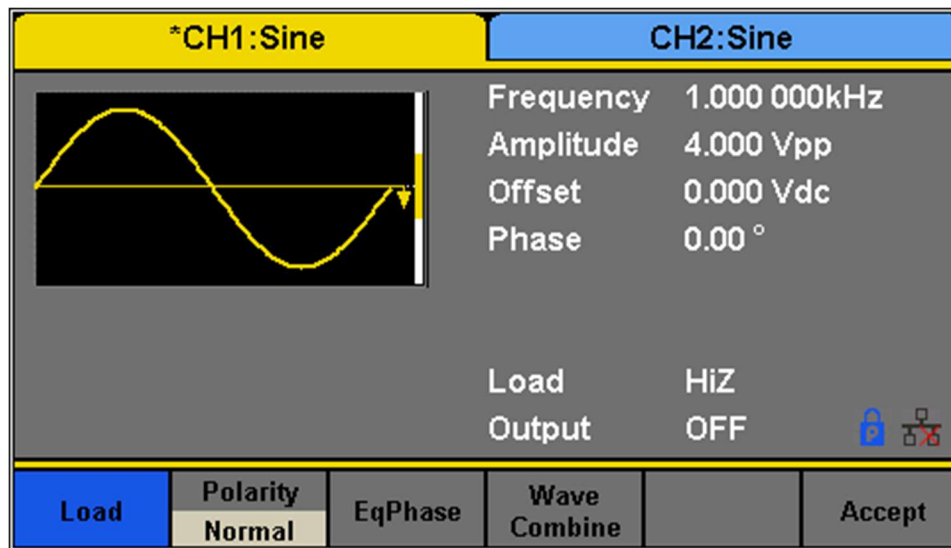

Figure 57 - Output Setup

## Load

For [CH1] and [CH2] connectors on the front panel, the generator has an output impedance of 50  $\Omega$ . If the load does not match the load impedance, the displayed voltage will not be the same as the output voltage setting on the generator. The Load function is used to match the displayed voltage with the expected one by *scaling the display* of the generator since this setting does not actually change the output impedance.

Steps for setting the load:

1. Press the **Utility** button.
2. Press the **Output Setup** softkey.
3. Press the **Load** softkey to change the output load display.
  - High Impedance: HiZ.
  - 50  $\Omega$  (default).

---

**Note:** Press the output key for two seconds to toggle between High Impedance and 50  $\Omega$ .

---

## Polarity

1. Press the **Utility** button.
2. Press the **Output Setup** softkey.
3. Press the **Polarity** softkey to set the output signal as normal or inverted. The waveform's inversion is relative to the offset voltage, as shown in the following figure.



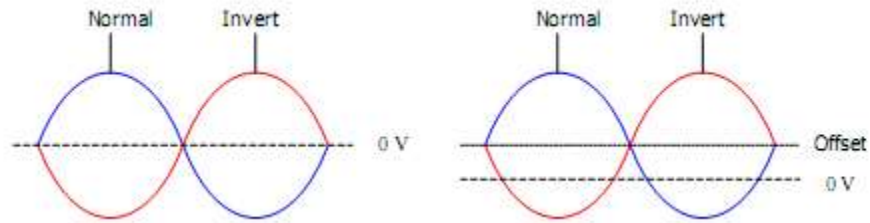

---

**Note: The Sync signal related to the waveform is not inverted when the waveform is inverted.**

---

## ***EqPhase***

The unit can set both channel 1 and channel 2 to be in phase. Once the selected channel has the required phase follow the steps below to copy the phase to the other channel:

1. Press the **Utility** button.
2. Press the **Output Setup**.
3. Press the **EqPhase** softkey to align the phases of CH1 and CH2.

## ***Combining Waveforms (Wave Combine)***

The CH1 output port of the generator outputs the waveform of CH1 in the normal mode, while the waveform of CH1+CH2 (the sum of the two waveforms) can be output in the combined mode. Similarly, the CH2 output port of the generator outputs the waveform of CH2 in the normal mode while the waveform of CH1+CH2 can be output in the combined mode.

1. Press the **Utility** button.
2. Press the **Output Setup** softkey.
3. Press the **Wave Combine** softkey to enter the waveforms combining interface, as shown in the following figure.

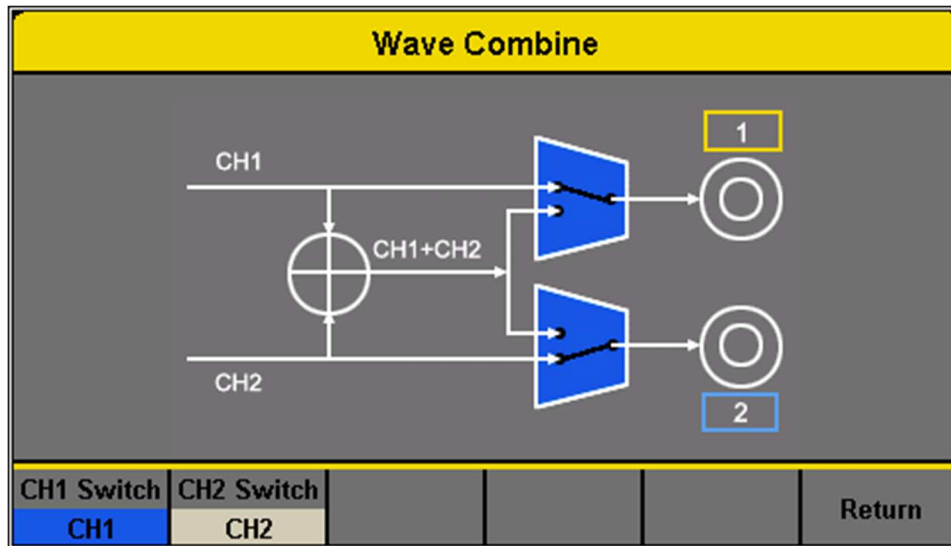

Figure 58 - Wave Combine Menu

Function Menu	Description	
<b>CH1 Switch</b>	<i>CH1</i>	Output the CH1 waveform.
	<i>CH1+CH2</i>	Output the CH1+CH2 waveform.
<b>CH2 Switch</b>	<i>CH2</i>	Output the CH2 waveform.
	<i>CH1+CH2</i>	Output the CH1+CH2 waveform.
<b>Return</b>		Save the current settings and exit the current interface.

- 
- Notes: 1. Combining with a Square waveform is not possible.  
 2. When the waveform combining function is enabled, the output impedance of the two channels will be set to be the same as the currently operated channel.
- 

## 4.5 CH Copy/Coupling

### **Channel Copy**

The generator supports a state and waveform copy function between its two channels. This copies all parameters and states (including the channel output state) and arbitrary waveform data from one channel to the other channel.

Function Menu	Description
<b>CH1=&gt;CH2</b>	Copy all parameters and states of CH1 to CH2.
<b>CH2=&gt;CH1</b>	Copy all parameters and states of CH2 to CH1.
<b>Accept</b>	Perform the current selection and return to the Utility menu.
<b>Cancel</b>	Give up the current selection and return to the Utility menu.

Table 25 - Channel Copy Options

To configure channel copy options, follow the steps below:

1. Press the **Utility** button.
2. Press the **CH Copy Coupling** softkey.
3. Press the **Channel Copy** softkey to enter the following interface.

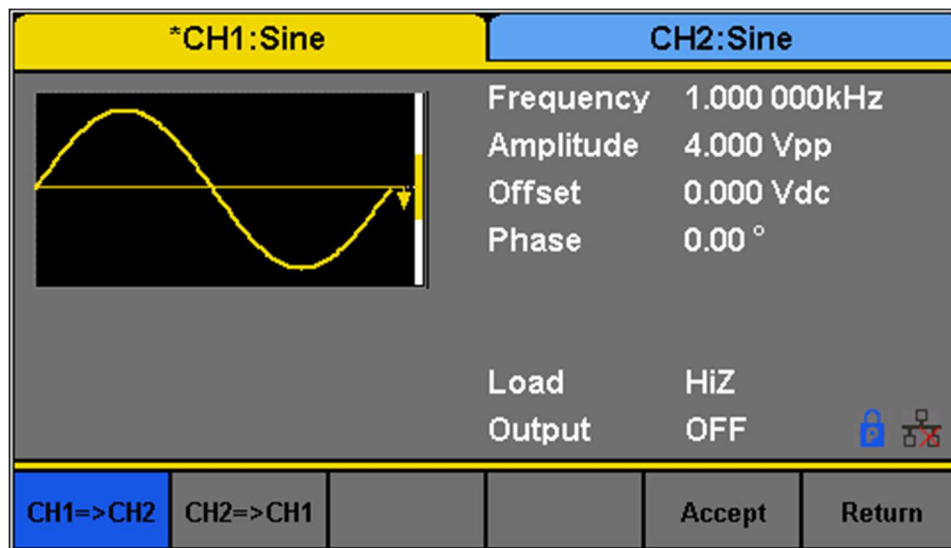

Figure 59 - Channel Copy

---

**Note:** The channel coupling or track function and the channel copy function are mutually exclusive. When channel coupling or track function is enabled, the menu Channel Copy is hidden.

---

### **Channel Coupling**

The generator supports frequency, amplitude and phase coupling. Users can set the frequency deviation/ratio, amplitude deviation/ratio or phase deviation/ratio of the two channels. When coupling is enabled, CH1 and CH2 can be modified simultaneously. When the frequency, amplitude or phase of one channel (as the reference) is changed, the corresponding parameter

of the other channel will be changed automatically and always keeps the specified frequency deviation/ratio, amplitude deviation/ratio or phase deviation/ratio relative to the modified channel.

To configure channel coupling settings, follow the instructions below:

1. Press the **Utility** button.
2. Press the **CH Copy Coupling** softkey.
3. Press the **Channel Coupling**, to enter the following menu:

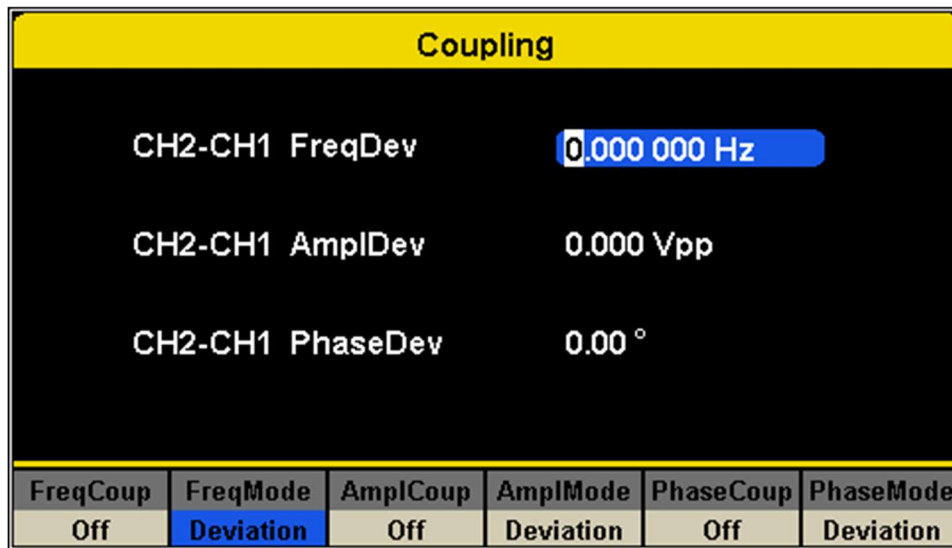

Figure 60 - Channel Coupling

### Frequency Coupling

To configure the **Frequency Coupling** function, follow the steps below:

1. Press the **FreqCoup** softkey to turn frequency coupling “On” or “Off”. The default is “Off”.
2. Press the **FreqMode** softkey to choose “Deviation” or “Ratio” and use the numeric keyboard or knob to input the desired value.
  - *Deviation*: the frequency deviation between CH1 and CH2. The resulting signal is represented by:  $\text{FreqCH2} - \text{FreqCH1} = \text{FreqDev}$ .
  - *Ratio*: the frequency ratio of CH1 and CH2. The resulting signal is represented by:  $\text{FreqCH2}/\text{FreqCH1} = \text{FreqRatio}$ .

### Amplitude Coupling

To configure the **Amplitude Coupling** function, follow the steps below:

1. Press **AmplCoup** to turn amplitude coupling “On” or “Off”. The default is “Off”.

2. Press **AmplMode** to choose “Deviation” or “Ratio” and use the numeric keyboard or knob to input the desired value.
  - *Deviation*: the amplitude deviation between CH1 and CH2. The resulting signal is represented by:  $\text{AmplCH2} - \text{AmplCH1} = \text{AmplDev}$ .
  - *Ratio*: the amplitude ratio of CH1 and CH2. The resulting signal is represented by:  $\text{AmplCH2} / \text{AmplCH1} = \text{AmplRatio}$ .

## Phase Coupling

To configure the **Phase Coupling** function, follow the steps below:

1. Press PhaseCoup to turn phase coupling “On” or “Off”. The default is “Off”.
2. Press PhaseMode to choose “Deviation” or “Ratio”, and then use the numeric keyboard or knob and arrow keys to input the desired value.
  - *Deviation*: the phase deviation between CH1 and CH2. The resulting signal is represented by:  $\text{PhaseCH2} - \text{PhaseCH1} = \text{PhaseDev}$ .
  - *Ratio*: the phase ratio of CH1 and CH2. The resulting signal is represented by:  $\text{PhaseCH2} / \text{PhaseCH1} = \text{PhaseRatio}$ .

---

**Notes:** 1. Channel coupling is only available when the waveforms of the two channels are basic waveforms: Sine, Square, Ramp and Arbitrary.

2. When the Phase Coupling function is enabled, if the phase of one channel is changed, the phase of the other channel will be changed accordingly. At this point, aligning phase between the two channels can be achieved without using the Eqphase operation.

3. Channel coupling and channel function are mutually exclusive. When channel coupling is enabled, the menu Channel Copy is hidden.

---

## Tracking

When the Tracking function is enabled, by changing the parameters or states of CH1, the corresponding parameters or states of CH2 will be adjusted to the same values or states automatically. At this point, the dual channels can output the same signal.

To configure the Tracking (Track) Function, follow the steps below:

1. Press the **Utility** button.
2. Press the **CH Copy Coupling** softkey.
3. Press the **Track** softkey to enable or disable the track function.

When the track function is enabled, channel copy and coupling functions are disabled. The channel selection is switched to CH1 and cannot be switched to CH2, as shown in the following figure.

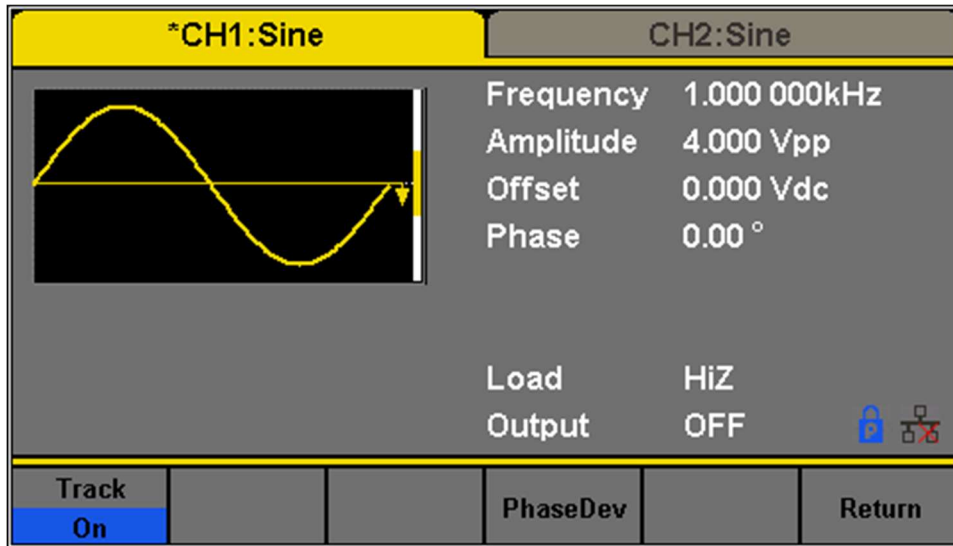

Figure 61 - Tracking

4. Press PhaseDev to enter the following menu:

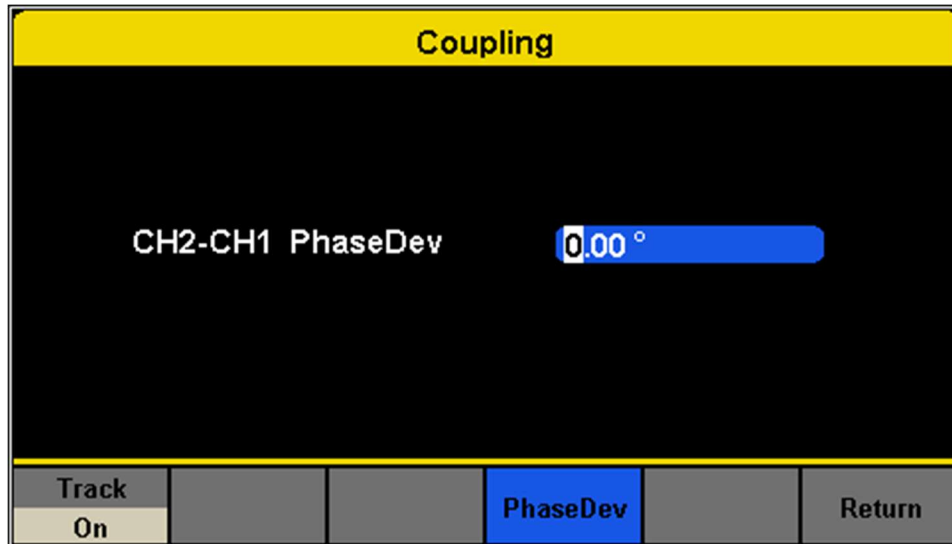

Figure 62 - Phase Deviation

5. Then use the numeric keyboard or knob and arrow keys to input the desired value for the phase deviation between CH1 and CH2. The resulting signal is represented by:  $\text{PhaseCH2} - \text{PhaseCH1} = \text{PhaseDev}$ .

## 4.6 Remote Interface

The 4050B Series can be controlled remotely via USB, LAN and GPIB (optional) interfaces.

1. Press the **Utility** button.
2. Press the **Page 1/2** softkey.
3. Press the **Interface** softkey to set the LAN parameters or GPIB address in the following screen:

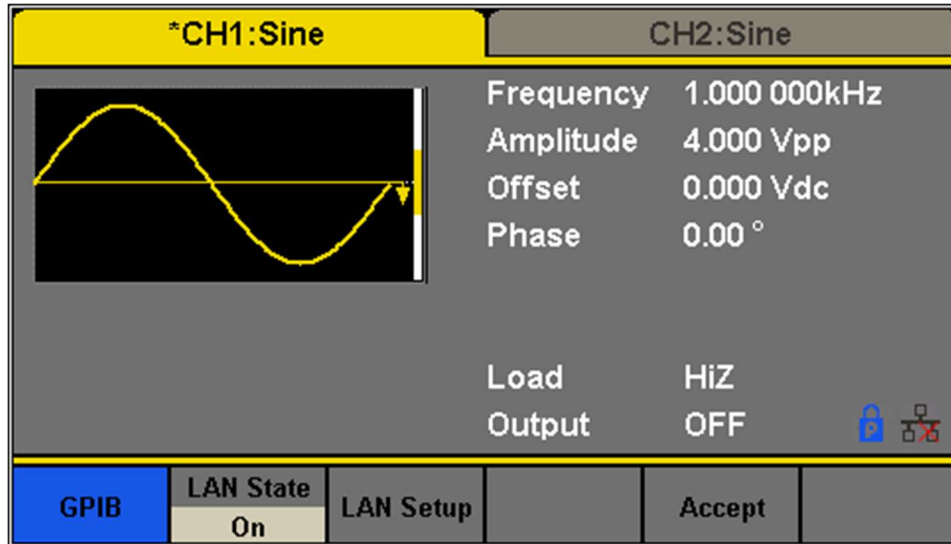

Figure 63 - Remote Interface

The unit will recognize if USBTMC or GPIB interface is being used and output to that interface. GPIB takes precedence as it locks the unit to GPIB mode when the adapter is connected to USB host in the front panel. LAN state is by default on. To use USBTMC or GPIB, set the LAN state to off.

Table 26 - Remote Interface Menu

Function Menu	Description	
<b>GPIB</b>	Set the GPIB address.	
<b>LAN State</b>	<i>On</i>	Turn on LAN.
	<i>Off</i>	Turn off LAN.
<b>LAN Setup</b>	Set the IP address, subnet mask and gateway.	
<b>Accept</b>	Save the current settings and return to the Utility menu.	

## **USB Interface**

The instrument has a USB interface (USBTMC) in the rear panel for remote communication with EasyWave software.

---

**Note: A type A to type B USB cable is required for PC connectivity.**

---

To connect with EasyWave software, you must install NI-VISA. NI-VISA is downloadable from **LabVIEW™** website. There are no settings for USBTMC. Make sure to set the LAN State to OFF.

---

**Note: Users who have LabVIEW™ or NI-VISA installed will automatically have this driver in their system. In this case, driver download is not required.**

---

## **GPIB Interface**

The generator can be remotely controlled via GPIB using the optional **AK40G USB-to-GPIB adapter**.

---

**Note: The AK40G is an adapter and not a GPIB controller. The computer must have a GPIB bus controller to connect to the adapter.**

---

---

**Note: Be sure all devices are powered off before connecting the adapter to the USB port of the generator and/or the GPIB port on your computer.**

---

## **Connecting AK40G**

1. Connect the USB end of the AK40G to the front USB host port of the instrument. Since this port is a shared port, an external USB flash drive cannot be used during GPIB operation.
2. Connect the GPIB end of the AK40G to the computer's GPIB bus controller via a GPIB cable.
3. On the AK40G adapter, a RED LED light indicates power to the adapter. A YELLOW LED light indicates communication is in process.



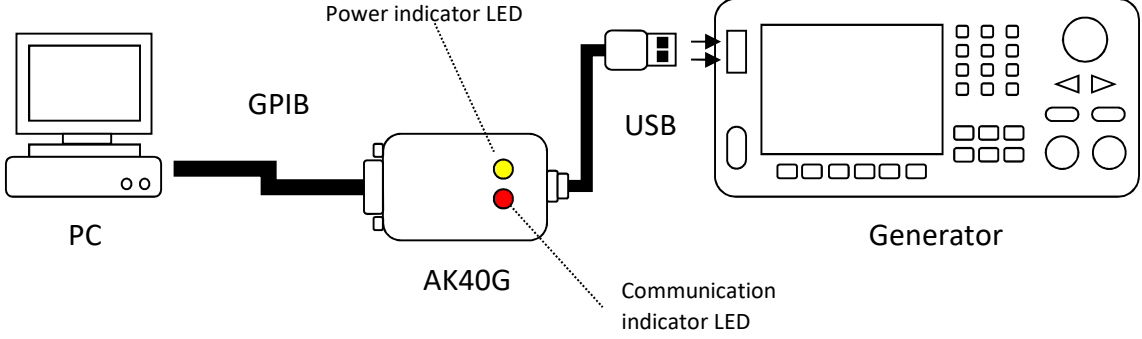



---

**Note: Once connected, do not unplug the adapter on either end before powering down the instrument and the computer first.**

---

**Configure GPIB address**

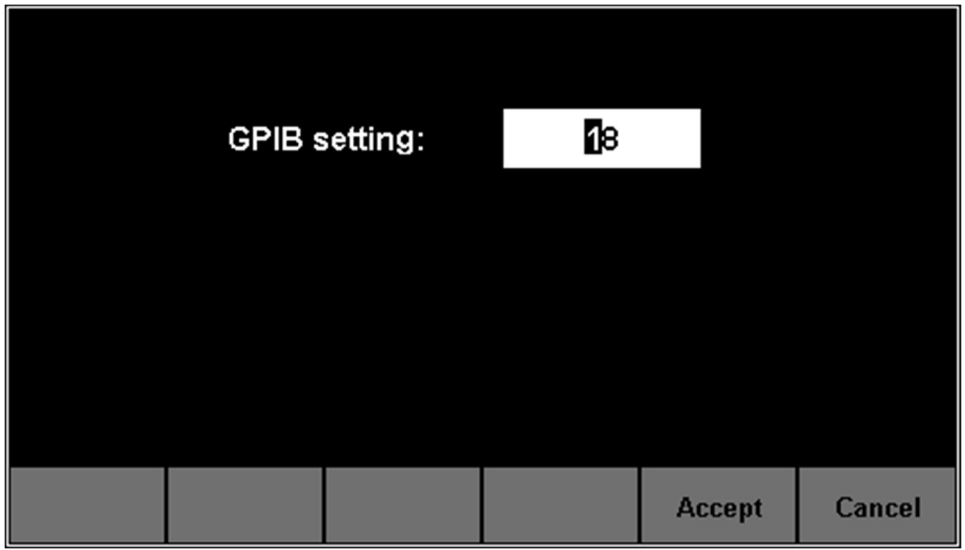
1. Press the **Utility** button.
2. Press the **1/2** softkey to enter the second page of the Utility menu.
3. Press the **Interface** softkey to select the remote interface.
4. Press **GPIB** and use the rotary knob to set the GPIB address of the generator. The address range is 1 to 30.
5. Press the **Accept** softkey to exit the GPIB setting screen.



6. Finally, press the **Accept** softkey again to exit to the main menu.

---

**Note: EasyWave software does not support GPIB interface. It must be used with USB interface only.**

---

**Note: All supported remote commands are described in the programming manual which can be downloaded from the B&K Precision website [www.bkprecision.com](http://www.bkprecision.com).**

---

## **LAN**

The 4050B SERIES can communicate with a PC through a LAN interface. Users can view and modify the LAN parameters.

1. Connect the generator to your local area network using the network cable.
2. Configure network parameters:
  - a. Press the **Utility** button.
  - b. Press the **1/2** softkey to enter the second page of the Utility menu.
  - c. Press the **Interface** softkey to select the remote interface.
  - d. Press the **LAN State** softkey to enable LAN and toggle it to **On**.
  - e. Then press the LAN Setup to enter the following menu:

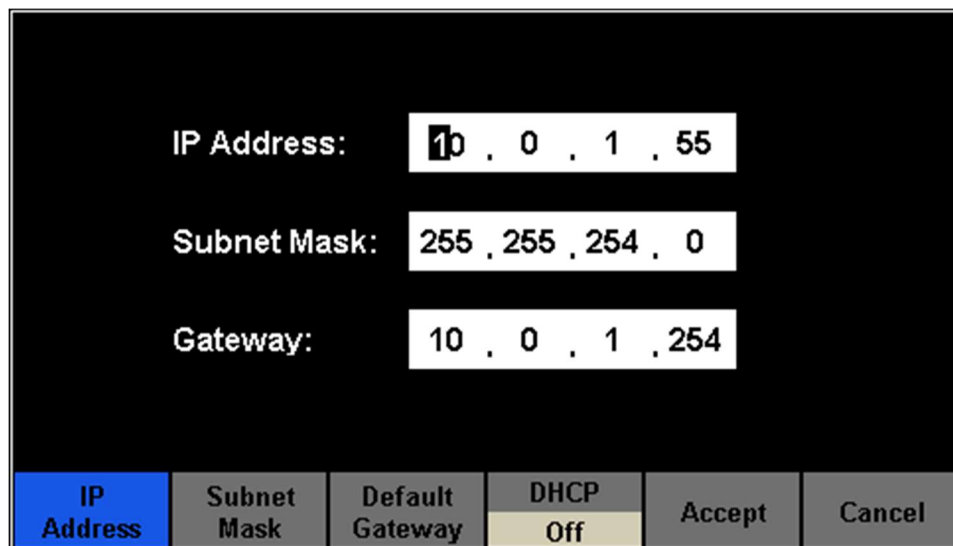

The screenshot shows a black background with white text for the LAN configuration menu. The settings are as follows:

IP Address:	10 . 0 . 1 . 55
Subnet Mask:	255 . 255 . 254 . 0
Gateway:	10 . 0 . 1 . 254

At the bottom, there is a row of six buttons: **IP Address** (highlighted in blue), **Subnet Mask**, **Default Gateway**, **DHCP Off** (highlighted in yellow), **Accept**, and **Cancel**.

Figure 65 - LAN Configuration

### **To Set IP Address**

The format of IP address is NNN. NNN. NNN. NNN. (where N is a number between 0-9). The first NNN ranges from 1 to 223 and the others range from 0 to 255.

Press **IP Address** and use the arrow keys and numeric keyboard or knob to enter the IP address. The setting is stored in non-volatile memory and will be loaded automatically when the generator is powered on.

### **To Set Subnet Mask**

The format of subnet mask is NNN. NNN. NNN.NNN and each NNN ranges from 0 to 255.

Press **Subnet Mask** and use the numeric keyboard or knob to enter your desired subnet mask. The setting is stored in non-volatile memory and will be loaded automatically when the generator is powered on.

### **To Set Gateway**

The format of gateway is NNN. NNN. NNN. NNN and each NNN ranges from 0 to 255.

Press Gateway and use the arrow keys and numeric keyboard or knob to enter your desired gateway. The setting is stored in non-volatile memory and will be loaded automatically when the generator is next powered on.

---

**Note: If the generator is connected to the PC directly, set the IP addresses, subnet masks and gateways for both of the PC and generator. The subnet masks and gateways of PC and generator must be the same and the IP addresses of them must be within the same network LAN IP range.**

---

### **DHCP Configuration Mode**

In DHCP mode, the DHCP server in the current network automatically assigns LAN parameters, e.g. IP address, for the generator. Press **DHCP** to select "On" or "Off" to turn DHCP mode on or off. The default is "Off".

## 4.7 Sync Output

The generator provides Sync output through the [Aux In/Out] connector on the rear panel. When the synchronization is on, the port can output a CMOS signal with the same frequency as basic waveforms (except Noise and DC), arbitrary waveforms, and modulated waveforms (except external modulation). Either channel 1 or channel 2 can be the waveform this signal is synchronized with.

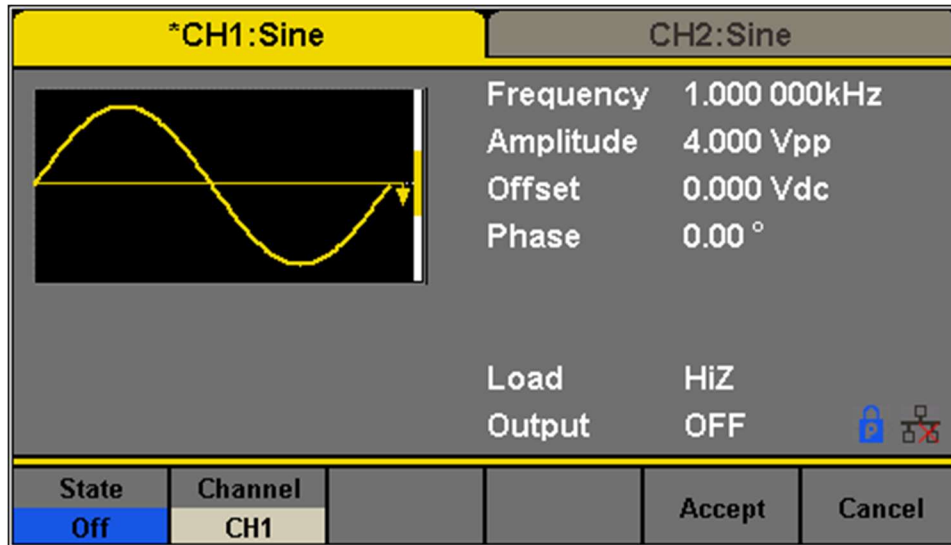

Figure 66 - Sync Output

Function	Description	
<b>State</b>	<i>Off</i>	Turn off the sync output.
	<i>On</i>	Turn on the sync output.
<b>Channel</b>	<i>CH1</i>	Set the sync signal to CH1 frequency.
	<i>CH2</i>	Set the sync signal of CH2 frequency.
<b>Accept</b>	Save the current settings and return to the Utility menu.	
<b>Cancel</b>	Cancel the current settings and return to the Utility menu.	

Table 27 - Sync Output Description

## ***Syncing Signals of Different Waveforms***

### **Basic Waveform and Arbitrary Waveform**

1. When the frequency of the waveform is less than or equal to 10 MHz, the sync signal is a Pulse with approximately 50 ns pulse width and the same frequency as the waveform.
2. When the frequency of the waveform is greater than 10 MHz, there is no sync signal output.
3. Noise and DC waveforms will have no sync signal output.

### **Modulated Waveform**

4. When internal modulation is selected, the sync signal is a Pulse with approximately 50 ns pulse width.
5. For AM, FM, PM and PWM, the frequency of the sync signal is the modulating frequency.
6. For ASK, FSK and PSK, the frequency of the sync signal is the key frequency.
7. When external modulation is selected, there is no sync signal output. The [Aux In/Out] connector on the rear panel is used to input the external modulating signal.

---

**Note: When Sweep or Burst function is enabled, there is no sync signal output and the Sync menu is hidden.**

---

## **4.8 Reference Clock**

The generator provides an internal 10 MHz clock source, which can output from the [10 Mhz In/Out] connector in the rear panel. The same connector also accepts an external clock signal.

To select or change the clock source, follow the steps below:

1. Press the **Utility** button.
2. Press the **Page 1/2** softkey.
3. Press the **CLKSource** softkey to select “Internal” or “External”.  
If “External” is selected, the instrument will scan if there is a valid external clock signal at the [10MHz In/Out] connector in the back panel. If there is no signal found, the

prompt message “No external clock source!” would be displayed and the clock source would be switched to “Internal”.

4. The unit can also output a 10 MHz clock signal when the **10MOut** is enabled. If the output of the clock signal is enabled, then the [10MHz In/Out] connector in the rear panel will function as an clock signal output only.

### ***Sync methods for two or more instruments:***

#### **Synchronization between two instruments**

Connect the [10MHz In/Out] connector of generator A (using internal clock) to the [10MHz In/Out] connector of generator B (using external clock) and set the output frequencies of A and B as a same value to achieve synchronization.

#### **Synchronization among multiple instruments**

Divide the 10 MHz clock source of a generator (using internal clock) into multiple channels and connect them to the [10MHz In/Out] connectors of other generators (using External clock). Then set the output frequencies of all the generators to the same value to achieve synchronization.

## **4.9 Mode**

The 4050B series has two modes of operation: Phase-Locked and Independent.

To select a mode of operation, follow the steps below:

1. Press the **Utility** button.
2. Press the **Page 1/2** softkey.
3. Press the Mode softkey to select a mode of operation.

- **Phase locked:**

When changing the frequency, the DDS of both channels are reset and the phase deviation between CH1 and CH2 is maintained.

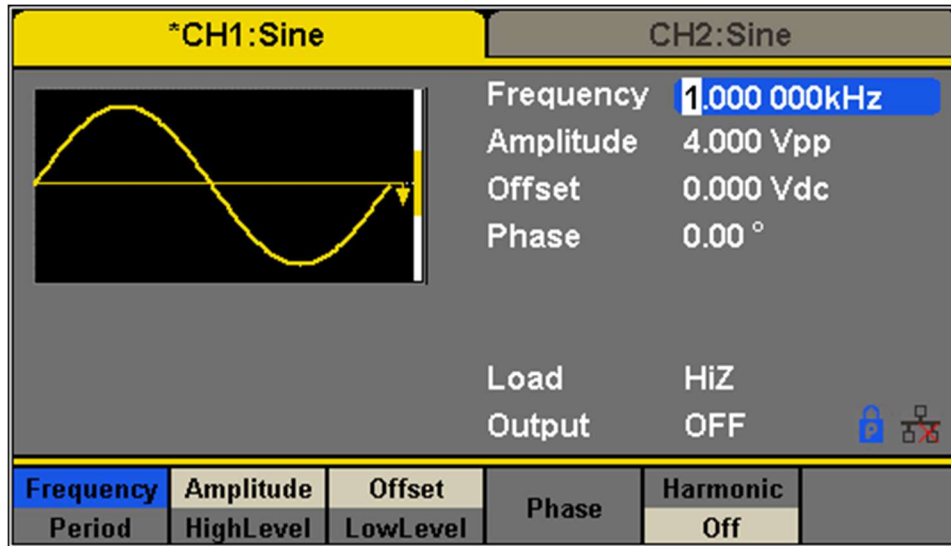

Figure 67 - Phase-Locked Mode

- **Independent Mode**

When changing the frequency, both channels' DDS don't reset and the phase deviation between CH1 and CH2 changes at random. When the independent mode is enabled, the phase parameter cannot be modified, and the Phase menu will be hidden as shown below.

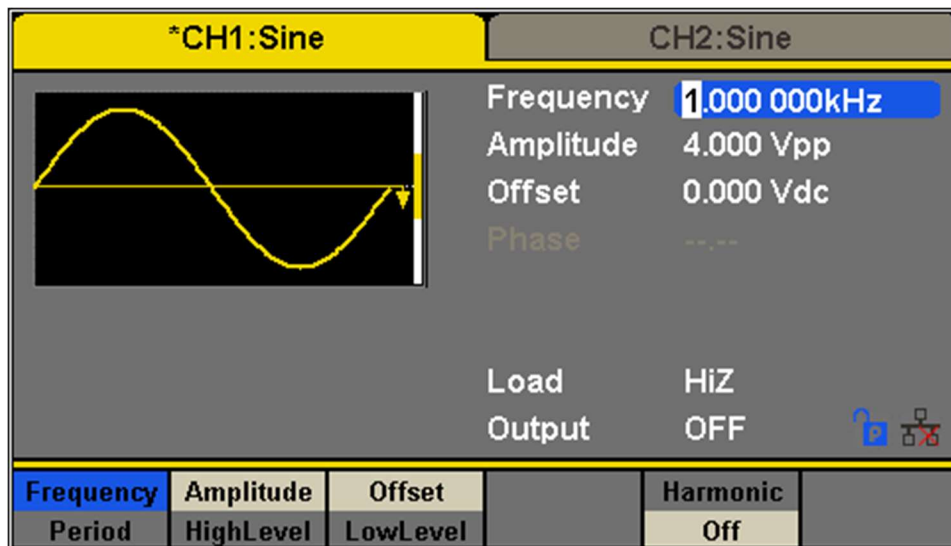

Figure 68 - Independent Mode

## 4.10 Over Voltage Protection

1. Press the **Utility** button.
2. Press the **Page 1/2** softkey.
3. Press the **OverVoltage Protection** to turn this function on or off.

When overvoltage protection occurs, a message will be displayed and the output will be disabled.

If set to ON, overvoltage protection of CH1 and CH2 will take effect when either of the following conditions are met.

- The absolute value of input voltage is higher than  $11\text{ V} \pm 0.5\text{ V}$  when the amplitude of the generator is  $\geq 2\text{ Vpp}$  or the absolute value of the DC offset is  $\geq 3\text{ V}$ .
- The absolute value of input voltage is higher than  $4\text{ V} \pm 0.5\text{ V}$  when the amplitude of the generator is  $< 2\text{ Vpp}$  or the absolute value of the DC offset is  $< 3\text{ V}$ .



## 5 Store and Recall

The 4050B series can store the current instrument state and user-defined arbitrary waveform data in internal or external memory and recall them when needed.

Press **Store/Recall** to enter the following interface.

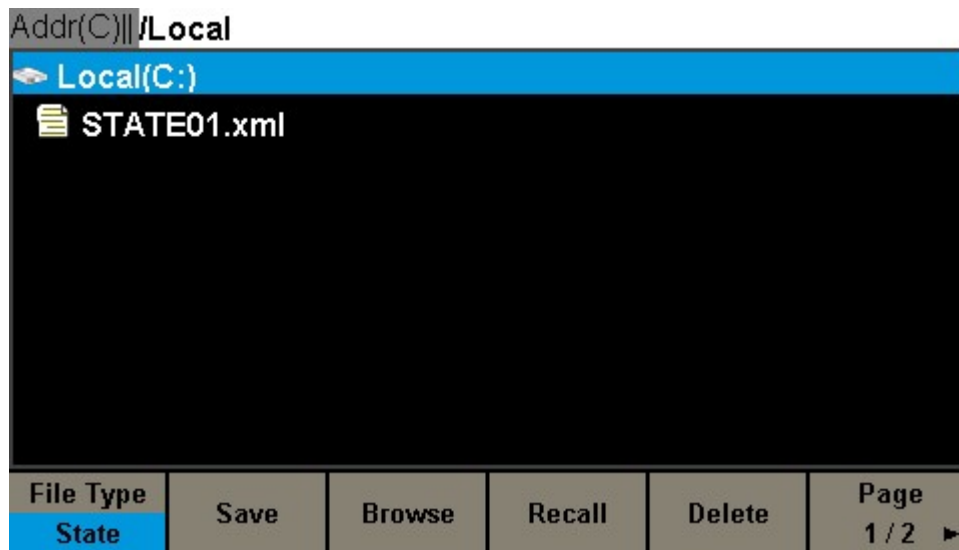

Figure 69 - Store/Recall Interface (Page 1)

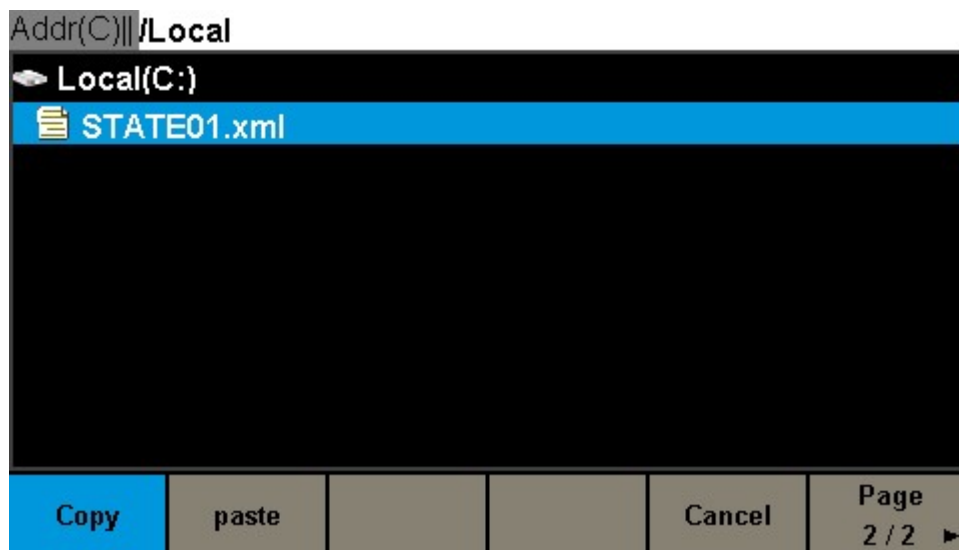

Figure 70 - Figure 45 - Store/Recall Interface (Page 2)

Function Menu	Settings	Description

<b>File Type</b>	State	Settings files.
	Data	Arbitrary waveform file.
<b>Browse</b>	View the current directory.	
<b>Save</b>	Save the waveform to the specified path.	
<b>Recall</b>	Recall the waveform or setting information in the specific position of the memory.	
<b>Delete</b>	Delete the selected file.	
<b>Copy</b>	Copy the selected file.	
<b>Paste</b>	Paste the selected file.	
<b>Cancel</b>	Exit the Store/Recall interface.	

Figure 71 - Store/Recall Interface

## 5.1 Storage System

The 4050B provides an internal non-volatile memory (C Disk) and a USB Host interface for external memory.

### **Local (C:)**

Users can store instrument states and arbitrary waveform files to C Disk.

### **USB Device (0:)**

There is a USB Host interface located on the left side of the front panel which permits users to store/recall waveforms or update the firmware version by U-Disk. When the generator detects a USB storage device, the screen will show the drive letter "USB Device (0:)" and display a prompt message "USB device connected.", as shown in . After removing the U-Disk, the screen will display a prompt message "USB device removed." And "USB Device (0:)" in the storage menu will disappear.



Figure 72 - Storage System

---

**Note:** The 4050B series can only identify files of which filenames consist of English letters, numbers and underscore. If other characters are used, the name may be displayed in the store and recall interface with errors or not found at all.

---

### ***Browse***

- Use the knob to shift between the directories to choose Local (C:) or USB Device (0:). Choose **Browse**, press the knob to open the current directory.
- Use the knob to switch between folder and files under the current directory. Choose **Browse**, press the knob to open the subdirectory. Choose **<up>**, then choose **Browse** or press the knob to return to the upper level directory.

## **5.2 File Type**

Choose **Store/Recall** → **File Type** to select the desired file type. Available file types are State File and Data File.

### **State File**

Store the instrument state in internal or external memory in “\*.xml” format. The state file stored includes waveform parameters and modulation, sweep, burst parameters of two channels and utility parameters.

## Data File

The 4050B can recall the data files in “.csv” or “.dat” format from the external memory and transfer them into “.bin” format then store them in the internal memory. When it is done, the generator will enter the arbitrary waveform interface automatically.

In addition, users can edit arbitrary waveforms with PC software — EasyWave, download them to the internal memory through remote interface and store them (”.bin” format) in the internal memory. To download EasyWave, please visit: [www.bkprecision.com](http://www.bkprecision.com).

## 5.3 Save the Instrument State

Users can store the current instrument state in internal and external memories. The storage will save the selected function (including the basic waveform parameters, modulation parameters and other utility settings used.)

To save the instrument state, the procedures are given as followed:

### 1. Selecting a file type to store.

Press **Store/Recall** → **File Type** → **State**, and choose state as the storage type.

### 2. Selecting the location of a file.

Choose a desired location by rotating the knob.

### 3. Naming a file.

Press **Save**, to enter the following interface.

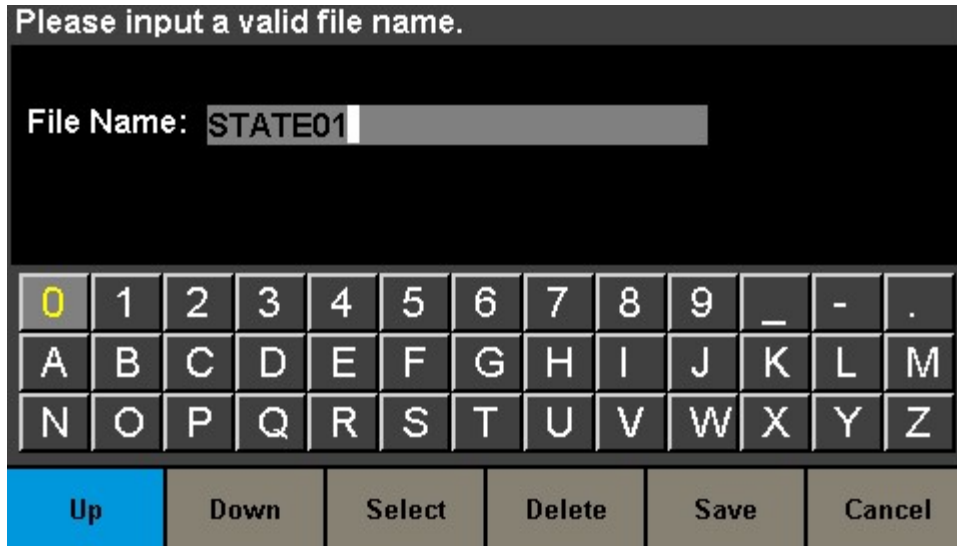

Figure 73 - Filename Input Interface

Item	Description
<b>Up</b>	Cursor upward to select.
<b>Down</b>	Cursor downward to select.
<b>Select</b>	Select the current character.
<b>Delete</b>	Delete the current character.
<b>Save</b>	Store the file with the current name.
<b>Cancel</b>	Return to the store/Recall interface.

- a. Users can select the desired letter, number or character from the virtual soft keyboard by using the knob or **Up** and **Down** menus.
- b. Then choose **Select** to display the character selected in the filename area.
- c. To delete a letter, number or character, use the left and right arrow keys to move the cursor in the file name. Then choose **Delete** to delete the corresponding character.

#### 4. Saving a file.

After finishing inputting filename, press **Save**. The generator will save the file under the currently selected directory with the specified filename.

## 5.4 Recall State File or Data File

To recall the instrument state or arbitrary waveform data, the procedures are as follows:

1. **Choose the file type.**

Press **Store/Recall** → **File Type**, and choose state or data as the storage type.

2. **Choose the file to be recalled.**

Rotate the knob to select the file you want to recall.

3. **Recall the file.**

Choose **Recall**, press the knob, the generator will recall the selected file and display corresponding prompt message when the file is read successfully.

## 5.5 Delete File

To delete the instrument state or arbitrary waveform data, the procedures are as follows:

1. **Choose the file.**

Rotate the knob to select the file you want to delete.

2. **Delete the file.**

Press the **Delete** softkey and the generator will display prompt message 'Delete the file?'  
Then press **Accept**, the generator will delete the currently selected file.

## 5.6 Copy and Paste File

4050B series supports the internal and external storage to copy files from each other. For example, copy an arbitrary wave file in the U-disk to the instrument, the procedure is as follows:

1. **Choose the file type.**

Press **Store/Recall** → **File Type**, and choose "Data" as the storage type.

**2. Choose the file to be copied.**

Rotate the knob to select USB Device (0:) and press the knob to open its directory. Then rotate the knob to select the file you want to copy and press **Page 1/2** → **Copy**.

**3. Paste the file.**

Rotate the knob to select Local (C:) and press the knob to open its directory. Then press **Paste**.

## 6 Examples

The examples below use the default settings of the instrument except in special cases.

This chapter includes the following topics:

- Example 1: Generate a Sine Waveform
- Example 2: Generate a Square Waveform
- Example 3: Generate a Ramp Waveform
- Example 4: Generate a Pulse Waveform
- Example 5: Generate a Noise
- Example 6: Generate a DC Waveform
- Example 7: Generate a Linear Sweep Waveform
- Example 8: Generate a Burst Waveform
- Example 9: Generate an AM Modulation Waveform
- Example 10: Generate an FM Modulation Waveform
- Example 11: Generate a PM Modulated Waveform
- Example 12: Generate an FSK Modulated Waveform
- Example 13: Generate an ASK Modulation Waveform
- Example 14: Generate a PSK Modulated Waveform
- Example 15: Generate a PWM Modulated Waveform
- Example 16: Generate a DSB-AM Modulated Waveform



### Example 1: Generate a Sine Waveform

Generate a sine waveform with 1 MHz frequency, 5 Vpp amplitude and 1 V DC offset.

- Set the frequency.
  1. Press **Waveforms** → **Sine** → **Frequency/Period** and choose **Frequency**, which will display in a blue color.
  2. Input '1' from the keyboard and choose the unit 'MHz'. The frequency will be set to 1 MHz.
- Set the Amplitude.
  1. Press **Amplitude/HighLevel** to choose **Amplitude** which will display in a blue color.
  2. Input '5' from the keyboard and choose the unit 'Vpp'. The amplitude will be set to 5 Vpp.
- Set the DC Offset.
  1. Press **Offset/LowLevel** to choose **Offset** which will display in a blue color.
  2. Input '1' from the keyboard and choose the unit 'Vdc'. The offset will be set to 1 V DC.

When the frequency, amplitude and offset are set, the waveform generated is shown in Figure

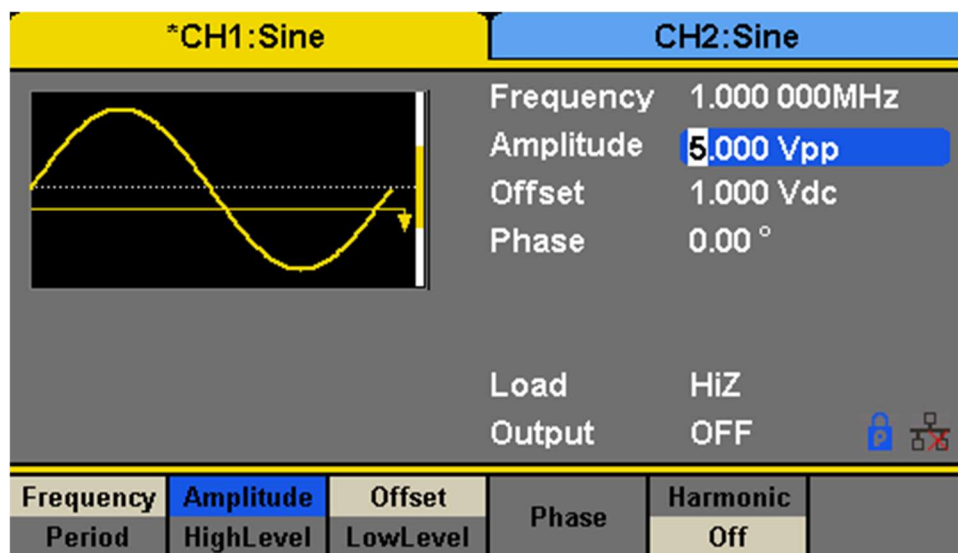

74.

Figure 74 - Generate a Sine Waveform

## Example 2: Generate a Square Waveform

Generate a square waveform with 5kHz frequency, 2 Vpp amplitude, 1 V DC offset and 30% duty cycle.

- Set the frequency.
  1. Press **Waveforms** → **Square** → **Frequency/Period** and choose **Frequency**, which will display in a blue color.
  2. Input '5' from the keyboard and choose the unit 'kHz'. The frequency is set to 5 kHz.
- Set the Amplitude.
  1. Press **Amplitude/HighLevel** to choose **Amplitude** which will display in a blue color.
  2. Input '2' from the keyboard and choose the unit 'Vpp'. The amplitude is set to 2 Vpp.
- Set the Offset.
  1. Press **Offset/LowLevel** to choose **Offset** which will display in a blue color.
  2. Input '1' from the keyboard and choose the unit 'Vdc'. The offset is set to 1 V DC.
- Set the DutyCycle.
  1. Press **DutyCycle** to choose **DutyCycle** which will display in a blue color.
  2. Input '30' from the keyboard and choose the unit '%'. The duty is set to 30%.

When the frequency, amplitude, offset and duty cycle are set, the waveform generated is shown in Figure 75.

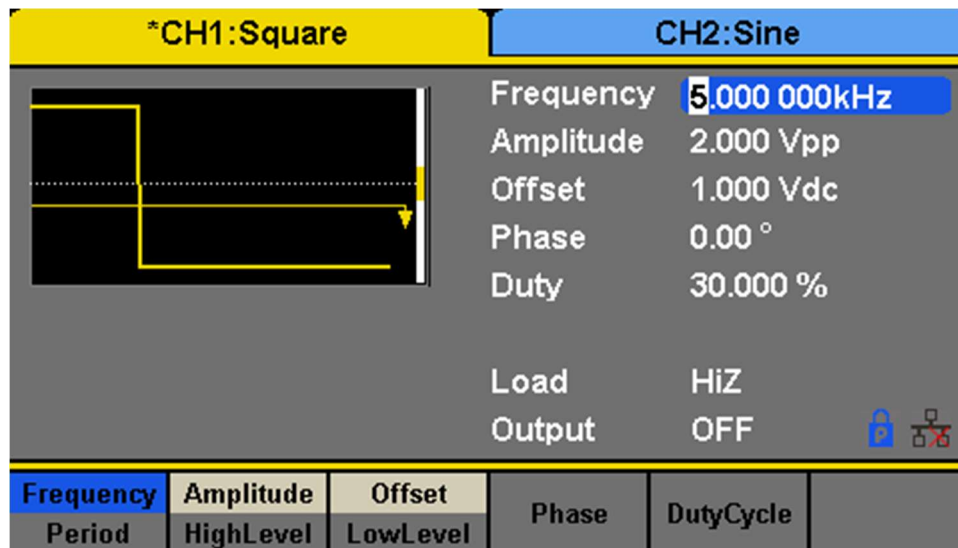

Figure 75 - Generate a Square Waveform

### **Example 3: Generate a Ramp Waveform**

Generate a ramp waveform with 10  $\mu$ s period, 100 mVpp amplitude, 20 mV DC offset, 45° phase and 30% symmetry.

- Set the Period.
  1. Press **Waveforms** → **Ramp** → **Frequency/Period** and choose **Period** which will display in a blue color.
  2. Input '10' from the keyboard and choose the unit ' $\mu$ s'. The period is set to 10  $\mu$ s.
- Set the Amplitude.
  1. Press **Amplitude/HighLevel** to choose **Amplitude** which will display in a blue color.
  2. Input '100' from the keyboard and choose the unit 'mVpp'. The amplitude is set to 100 mVpp.
- Set the DC Offset.
  1. Press **Offset/LowLevel** to choose **Offset** which will display in a blue color.
  2. Input '20' from the keyboard and choose the unit 'mVdc'. The offset is set to 20 mV DC.
- Set the Phase.
  1. Press **Phase** to choose **Phase** which will display in a blue color.
  2. Input '45' from the keyboard and choose the unit '°' (degrees). The phase is set to 45°.
- Set the Symmetry.
  1. Press **Symmetry** to choose **Symmetry** which will display in a blue color.
  2. Input '30' from the keyboard and choose the unit '30%'. The symmetry is set to 30%.

When the period, amplitude, offset, phase and symmetry are set, the waveform generated is shown in Figure 76.

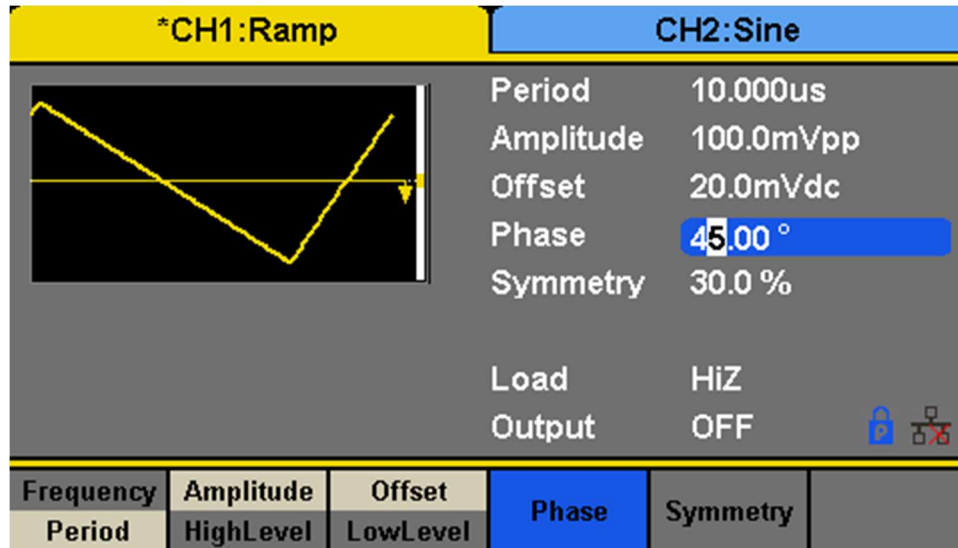

Figure 76 - Generate a Ramp Waveform

#### Example 4: Generate a Pulse Waveform

Generate a pulse waveform with 5 kHz frequency, 5 V high level, -1 V low level, 40  $\mu$ s pulse width and 20 ns delay.

- Set the Frequency.
  1. Press **Waveforms** → **Pulse** → **Frequency/Period** and choose **Frequency**, which will display in a blue color.
  2. Input '5' from the keyboard and choose the unit 'kHz'. The frequency is set to 5 kHz.
- Set the HighLevel.
  1. Press **Amplitude/HighLevel** and choose the **HighLevel** which will display in a blue color.
  2. Input '5' from the keyboard and choose the unit 'V'. The high level is set to 5 V.
- Set the LowLevel.
  1. Press **Offset/LowLevel** and choose the **LowLevel** which will display in a blue color.
  2. Input '-1' from the keyboard and choose the unit 'V'. The low level is set to -1 V.
- Set the PulWidth.
  1. Press **PulWidth/DutyCycle** and choose **PulWidth** which will display in a blue color.
  2. Input '40' from the keyboard and choose the unit ' $\mu$ s'. The pulse width is set to 40  $\mu$ s.
- Set the Delay.

1. Press **Delay** to choose **Delay** which will display in a blue color.
2. Input '20' from the keyboard and choose the unit 'ns'. The delay is set to 20 ns.

When the frequency, high level, low level, pulse width and delay are set, the waveform generated is shown in Figure 77.

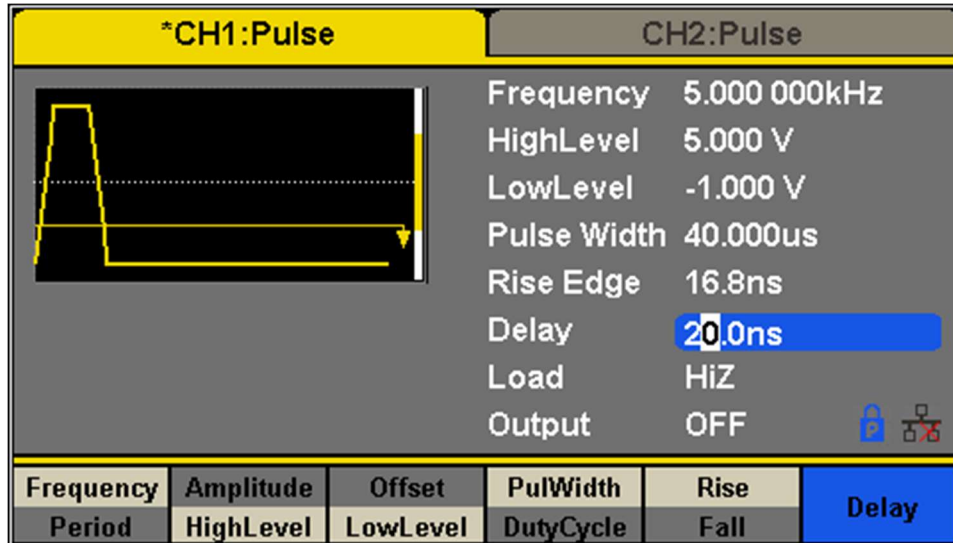

Figure 77 - Generate a Pulse Waveform

### Example 5: Generate a Noise

Generate a noise waveform with 0.5 V standard deviation and a 1 V mean.

- Set the Stdev.
  1. Press **Waveforms** → **Noise** → **Stdev** to choose **Stdev** which will display in a blue color.
  2. Input '0.5' from the keyboard and choose the unit 'V'. The standard deviation is set to 0.5 V.
- Set the Mean.
  1. Press **Mean** to choose **Mean** which will display in a blue color.
  2. Input '1' from the keyboard and choose the unit 'V'. The mean is set to 1 V.

When the standard deviation and mean are set, the noise generated is shown in Figure 78.

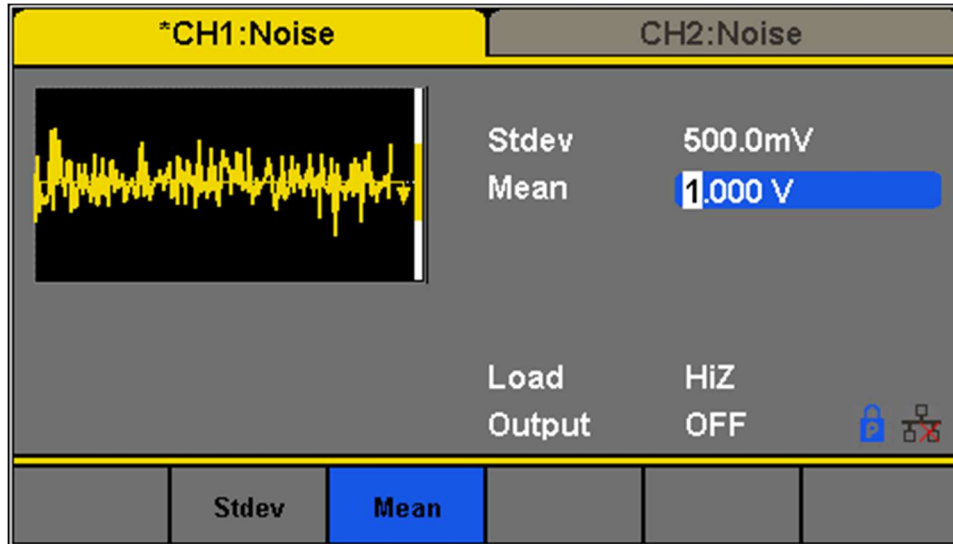

Figure 78 - Generate a Noise Waveform

### ***Example 6: Generate a DC Waveform***

Generate a 3 V DC waveform.

- Choose the DC waveform.

1. Press **Waveforms** → **Page 1/2** → **DC** to choose the DC waveform.

- Set the Offset.

1. Press **Offset** and choose **Offset** which will display in a blue color.

2. Input '3' from the keyboard and choose the unit 'Vdc'. The DC offset is set to 3 V.

When the DC offset is set, the waveform generated is shown in Figure 79.

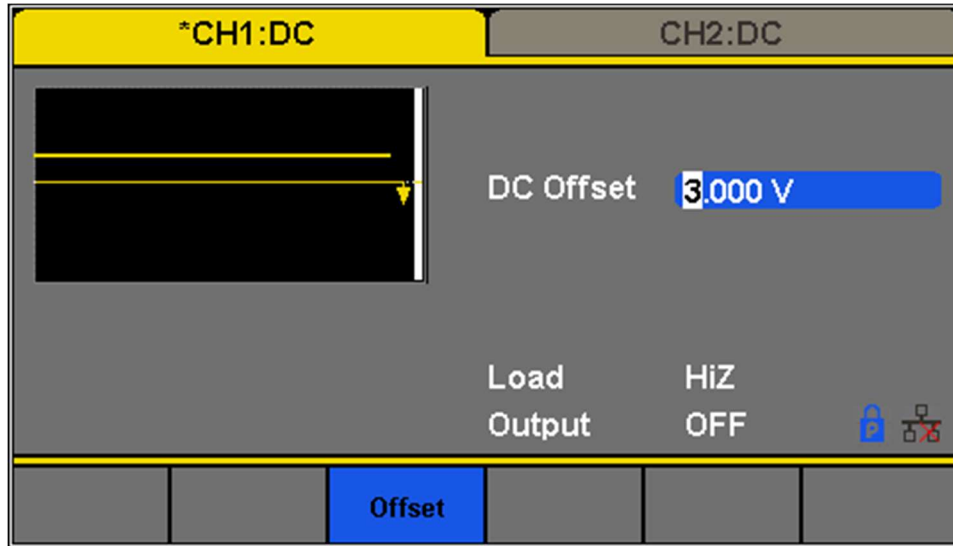

Figure 79 - Generate a DC Waveform

### Example 7: Generate a Linear Sweep Waveform

Generate a sine sweep waveform whose frequency starts at 100 Hz and sweeps to a frequency of 10 kHz. Use internal trigger mode, linear sweep, and a sweep time of 2 s.

- Set the sweep function.  
Press **Waveforms** and choose the sine waveform as the sweep function. The default setting of the source is internal.
- Set the amplitude and offset.
  1. Press **Amplitude/HighLevel** to choose **Amplitude** which will display in a blue color. Input '5' from the keyboard and choose the unit 'Vpp' to set the amplitude to 5 Vpp.
  2. Press **Offset/LowLevel** to choose **Offset** which will display in a blue color. Input '0' from the keyboard and choose the unit 'Vdc' to set the offset to 0 V DC
- Set the sweep time.  
Press **Sweep** → **Page 1/2** → **Sweep Time**, input '1' from the keyboard and choose the unit 's' to set the sweep time to 1 s.
- Set the start frequency.  
Press **StartFreq**, input '100' from the keyboard and choose the unit 'Hz' to set the start frequency to 100 Hz.

- Set the stop frequency.

Press **StopFreq**, input '10' from the keyboard and choose the unit 'kHz' to set the stop frequency to 10 kHz.

- Set the sweep profiles.

Press **Type** and choose **Linear**.

When all parameters above are set, the linear sweep waveform generated is shown in Figure 80.

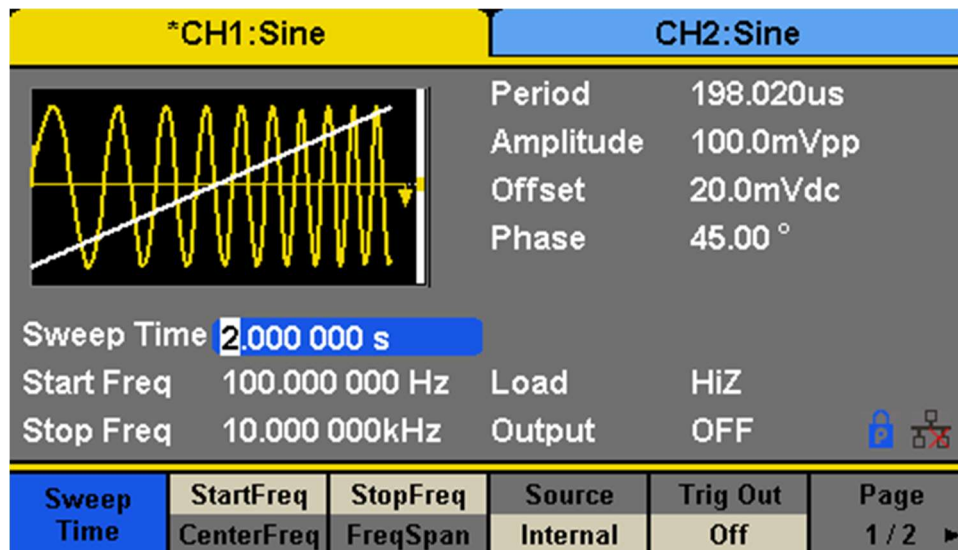

Figure 80 - Generate a Linear Sweep Waveform

### Example 8: Generate a Burst Waveform

Generate a burst sine waveform with 5 cycles. The burst period is 3 ms. Use internal trigger and 0° start phase.

- Set the burst function.

Press **Waveforms**, and choose the sine waveform as the burst function.

- Set the frequency, amplitude and offset.

1. Press **Frequency/Period** and choose **Frequency** which will display in a blue color. Input '10' from the keyboard and choose the unit 'kHz' to set the frequency to 10 kHz.
2. Press **Amplitude/HighLevel** to choose **Amplitude** which will display in a blue color. Input '4'



from the keyboard and choose the unit 'Vpp' to set the amplitude to 4 Vpp.

3. Press **Offset/LowLevel** to choose **Offset** which will display in blue color. Input '0' from the keyboard and choose the unit 'Vdc' to set the DC offset to 0 V DC.

- Set the burst mode.

Press **Burst** → **NCycle** and choose N-Cycle Mode. The default setting of the source is internal.

- Set the burst period.

Press **Burst Period**, input '3' from the keyboard and choose the unit 'ms' to set the burst period to 3 ms.

- Set the start phase.

Press **Start Phase**, input '0' from the keyboard and choose the unit '°' to set the start phase to 0°.

- Set the burst cycle.

Press **Cycle**, Input '5' from the keyboard and choose the unit 'Cycle' to set the burst cycle count to 5.

- Set the delay.

Press **Page 1/2** to choose **Delay**, and input '100' from the keyboard and choose the unit 'µs' to set the delay to 100 µs.

When all parameters above are set, the waveform generated is shown in Figure 81.

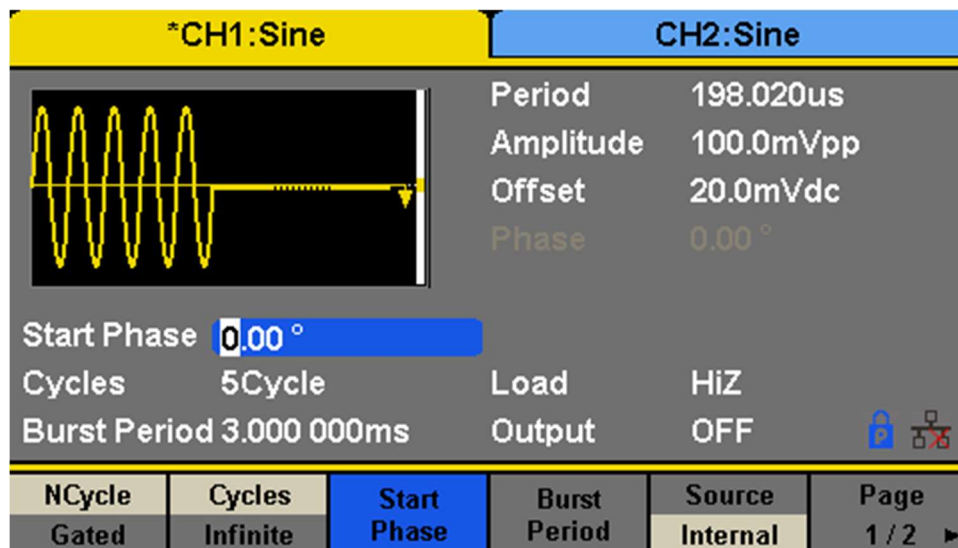

Figure 81 - Generate a N-Cycle Burst Waveform

### Example 9: Generate an AM Modulation Waveform

Generate an amplitude-modulated waveform with 80% depth. The carrier is a sine wave with 10 kHz frequency and the modulating wave is a sine wave with 200 Hz frequency.

- Set the frequency, amplitude and offset of the carrier wave.
  1. Press **Waveforms** and choose the sine waveform as the carrier wave.
  2. Press **Frequency/Period** and choose **Frequency** which will display in a blue color. Input '10' from the keyboard and choose the unit 'kHz' to set the frequency to 10 kHz
  3. Press **Amplitude/HighLevel** and choose **Amplitude** which will display in blue color. Input '1' from the keyboard and choose the unit 'Vpp' to set the amplitude to 1 Vpp.
  4. Press **Offset/LowLevel** and choose **Offset** which will display in a blue color. Input '0' from the keyboard and choose the unit 'Vdc' to set the offset to 0 V DC.
- Set the modulation type to AM and its parameters.
  1. Press **Mod** → **Type** → **AM** and choose AM. The message shown on the middle left side of the screen is 'AM'.
  2. Press **AM Freq**, input '200' from the keyboard and choose the unit 'Hz' to set the AM Freq to 200 Hz.
  3. Press **AM Depth**, input '80' from the keyboard and choose the unit '%' to set the AM depth to 80%.
  4. Press **Shape** → **Sine**, to choose sine wave as the modulating waveform.

When all parameters above are set, the waveform generated is shown in Figure 82.

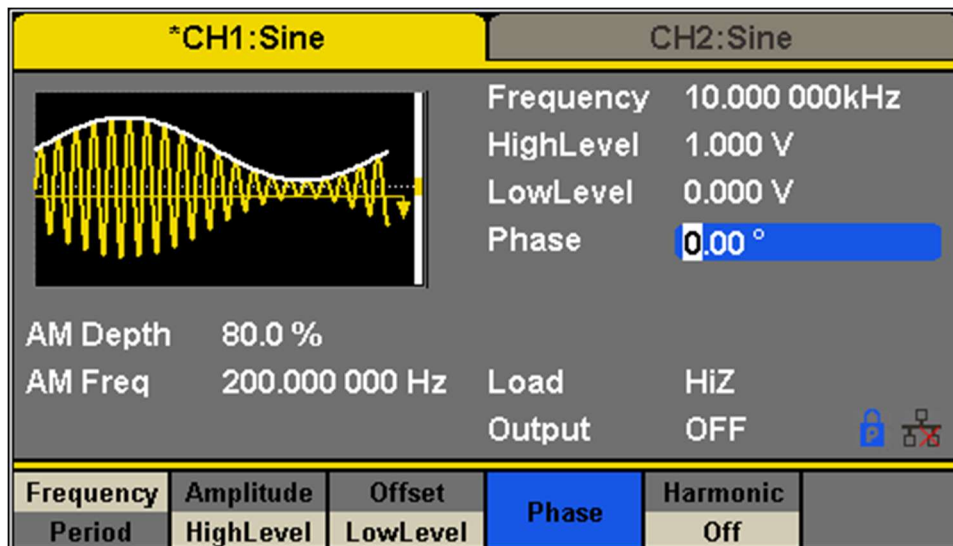

Figure 82 - Generate an AM Modulation Waveform

### Example 10: Generate an FM Modulation Waveform

Generate an FM modulation waveform: the carrier is a sine wave with 10 kHz frequency, the modulating wave is a sine wave with 1 Hz frequency and 2 kHz frequency deviation.

- Set the frequency, amplitude and offset of the carrier wave.
  1. Press **Waveforms** and choose the sine waveform as the carrier wave.
  2. Press **Frequency/Period** and choose **Frequency** which will display in a blue color. Input '10' from the keyboard and choose the unit 'kHz' to set the frequency to 10 kHz
  3. Press **Amplitude/HighLevel** and choose **Amplitude** which will display in a blue color. Input '1' from the keyboard and choose the unit 'Vpp' to set the amplitude to 1 Vpp.
  4. Press **Offset/LowLevel** and choose **Offset** which will display in a blue color. Input '0' from the keyboard and choose the unit 'Vdc' to set the offset to 0 dV DC.
- Set the modulation type FM and its parameters.
  1. Press **Mod** → **Type** → **FM**, choose FM. The message shown on the middle left side of the screen is 'FM'.
  2. Press **FM Freq**, input '1' from the keyboard and choose the unit 'Hz' to set the FM Freq to 1 Hz.
  3. Press **FM Dev**, input '2' from the keyboard and choose the unit 'kHz' to set the FM deviation to 2 kHz.
  4. Press **Shape** → **Sine**, to choose sine wave as the modulating waveform.

When all parameters above are set, the waveform generated is shown in Figure 83.

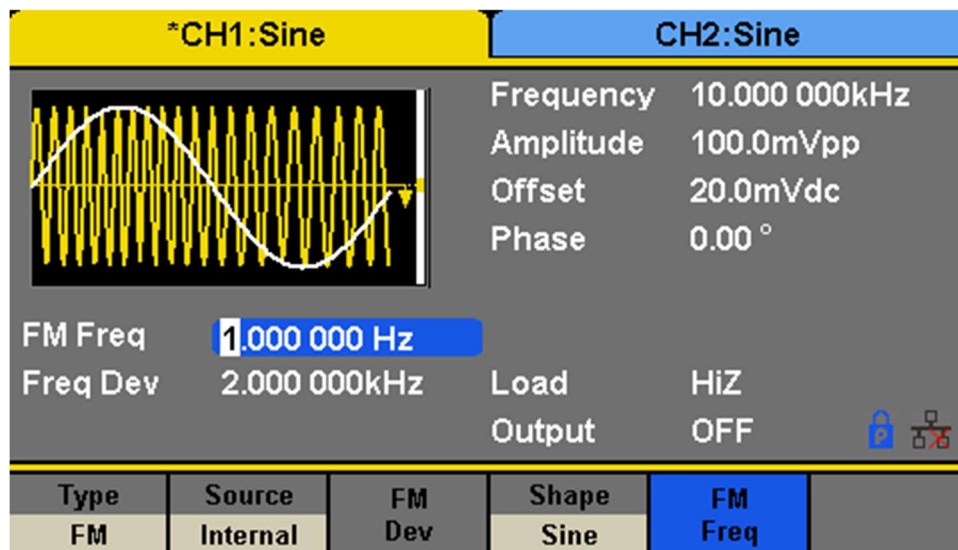

Figure 83 - Generate a FM Modulation Waveform

### Example 11: Generate a PM Modulated Waveform

Generate a PM modulated waveform, the carrier is a sine wave with 10 kHz frequency, and the modulating wave is a sine wave with 2 kHz frequency and 90° phase deviation.

- Set the frequency, amplitude and offset of the carrier wave.
  1. Press **Waveforms**, and choose the sine waveform as the carrier wave.
  2. Press **Frequency/Period** and choose **Frequency** which will display in a blue color. Input '10' from the keyboard and choose the unit 'kHz' to set the frequency to 10 kHz
  3. Press **Amplitude/HighLevel** and choose **Amplitude** which will display in a blue color. Input '5' from the keyboard and choose the unit 'Vpp' to set the amplitude to 5 Vpp.
  4. Press **Offset/LowLevel** and choose **Offset** which will display in a blue color. Input '0' from the keyboard and choose the unit 'Vdc' to set the offset to 0 V DC.
- Set the modulation type PM and parameters.
  1. Press **Mod** → **Type** → **PM** and choose PM. The message shown on the middle left side of the screen is 'PM'.
  2. Press **PM Freq**, input '2' from the keyboard and choose the unit 'kHz' to set the PM Freq to 2 kHz.
  3. Press **Phase Dev**, input '90' from the keyboard and choose the unit '°' to set the phase deviation to 90°.
  4. Press **Shape** → **Sine** to choose a sine wave as the modulating waveform.

When all parameters above are set, the waveform generated is shown in Figure 84.

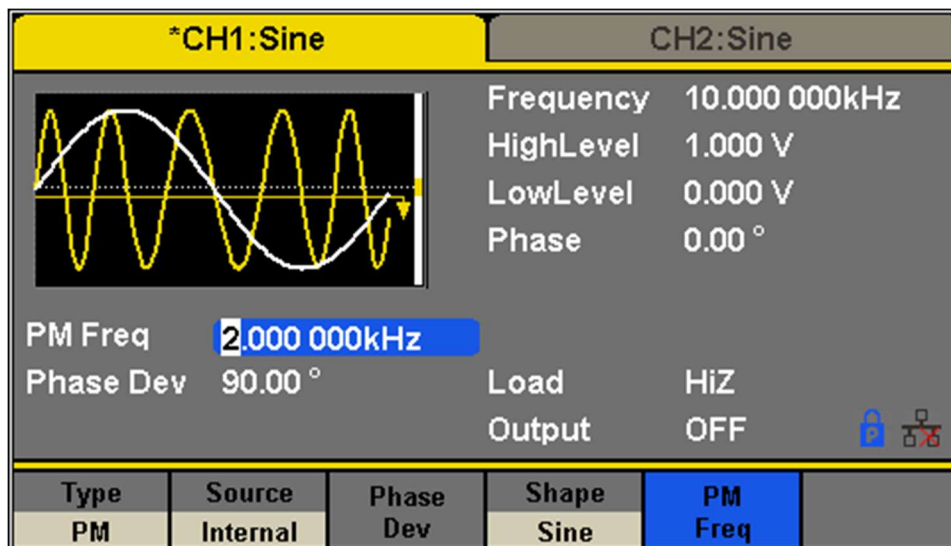

Figure 84 - Generate a PM Modulation Waveform

### Example 12: Generate an FSK Modulated Waveform

Generate an FSK modulated waveform with a 200 Hz key frequency. The carrier is a sine wave with a 10 kHz frequency and the hop frequency is 500 Hz.

- Set the frequency, amplitude and offset of the carrier wave.
  1. Press **Waveforms** and choose the sine waveform as the carrier wave.
  2. Press **Frequency/Period** and choose **Frequency** which will display in a blue color. Input '10' from the keyboard and choose the unit 'kHz' to set the frequency to 10 kHz.
  3. Press **Amplitude/HighLevel** and choose **Amplitude** which will display in a blue color. Input '5' from the keyboard and choose the unit 'Vpp' to set the amplitude to 5 Vpp.
  4. Press **Offset/LowLevel** and choose **Offset** which will display in a blue color. Input '0' from the keyboard and choose the unit 'Vdc' to set the offset to 0 V DC.
- Set the modulation type FSK and its parameters.
  1. Press **Mod** → **Type** → **FSK** and choose FSK. The message shown on the middle left side of the screen is 'FSK'.
  2. Press **Key Freq**, input '200' from the keyboard and choose the unit 'Hz' to set the key frequency to 200 Hz.
  3. Press **Hop Freq**, input '500' from the keyboard and choose the unit 'Hz' to set the hop frequency to 500 Hz.

When all parameters above are set, the waveform generated is shown in Figure 85.

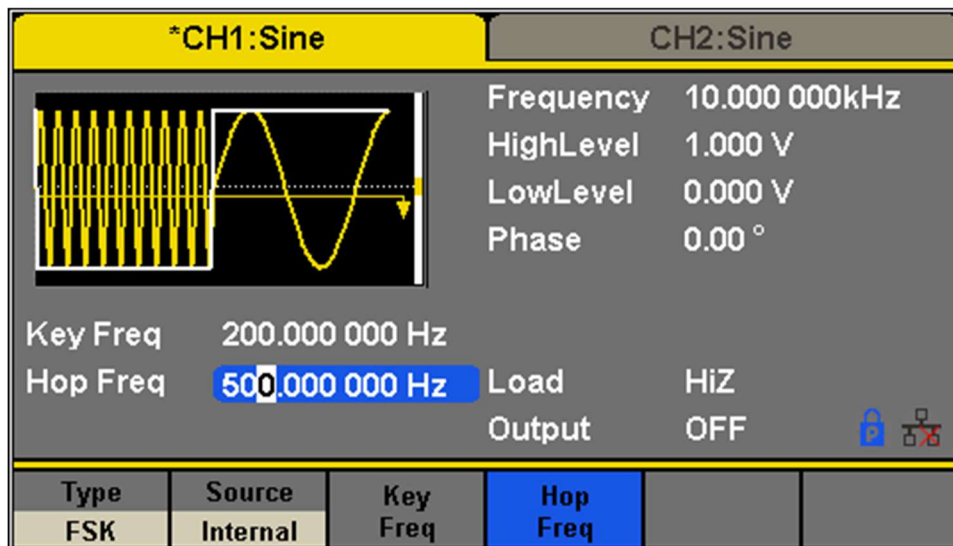

Figure 85 - Generate a FSK Modulation Waveform

### Example 13: Generate an ASK Modulation Waveform

Generate an ASK modulation waveform with 500 Hz key frequency. The carrier is a sine wave with 5 kHz frequency.

- Set the frequency, amplitude and offset of the carrier wave.
  1. Press **Waveforms** and choose the sine waveform as the carrier wave
  2. Press **Frequency/Period** and choose **Frequency** which will display in a blue color. Input '5' from the keyboard and choose the unit 'kHz' to set the frequency to 5 kHz
  3. Press **Amplitude/HighLevel** and choose **Amplitude** which will display in a blue color. Input '5' from the keyboard and choose the unit 'Vpp' to set the amplitude to 5 Vpp.
  4. Press **Offset/LowLevel** and choose **Offset** which will display in a blue color. Input '0' from the keyboard and choose the unit 'Vdc' to set the offset to 0 V DC.
- Set the modulation type ASK and its parameters.
  1. Press **Mod** → **Type** → **ASK**, choose ASK. The message shown on the middle left side of the screen is 'ASK'.
  2. Press **Key Freq**, input '500' from the keyboard and choose the unit 'Hz' to set the key frequency to 500 Hz.

When all parameters above are set, the waveform generated is shown in Figure 86.

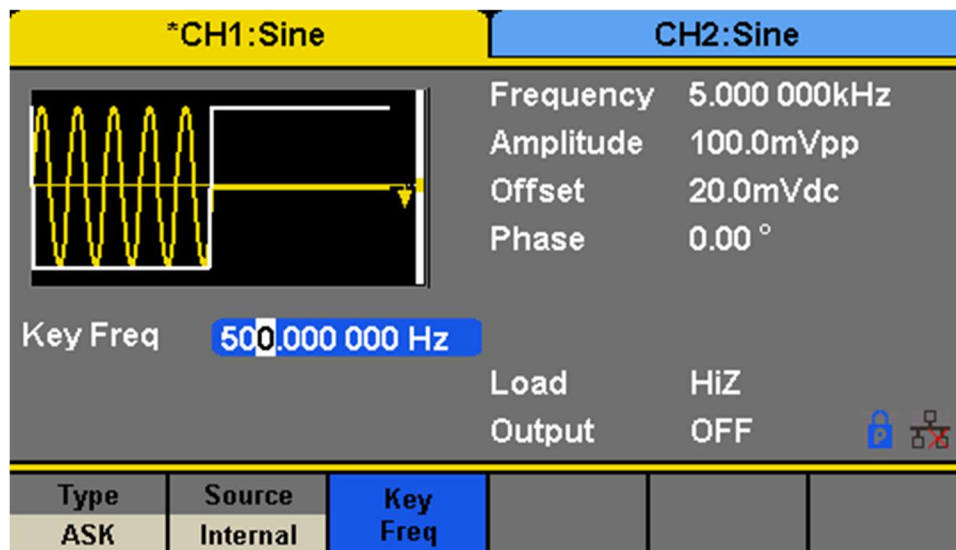

Figure 86 - Generate a ASK Modulation Waveform

### Example 14: Generate a PSK Modulated Waveform

Generate a PSK modulated waveform with 200 Hz key frequency. The carrier is a sine wave with 1 kHz frequency.

- Set the frequency, amplitude and offset of the carrier wave.
  1. Press **Waveforms** and choose the sine waveform as the carrier wave
  2. Press **Frequency/Period** and choose **Frequency** which will display in a blue color. Input '1' from the keyboard and choose the unit 'kHz' to set the frequency to 1 kHz
  3. Press **Amplitude/HighLevel** and choose **Amplitude** which will display in a blue color. Input '5' from the keyboard and choose the unit 'Vpp' to set the amplitude to 5 Vpp.
  4. Press **Offset/LowLevel** and choose **Offset** which will display in a blue color. Input '0' from the keyboard and choose the unit 'Vdc' to set the offset to 0 V DC.
- Set the modulation type PSK and parameters.
  1. Press **Mod** → **Type** → **Page 1/2** → **PSK**, choose PSK. The message shown on the middle left side of the screen is 'PSK'.
  2. Press **Key Freq**, input '200' from the keyboard and choose the unit 'Hz' to set the key frequency to 200 Hz.
  3. Press **Polarity** → **Positive**.

When all parameters above are set, the waveform generated is shown in Figure 87

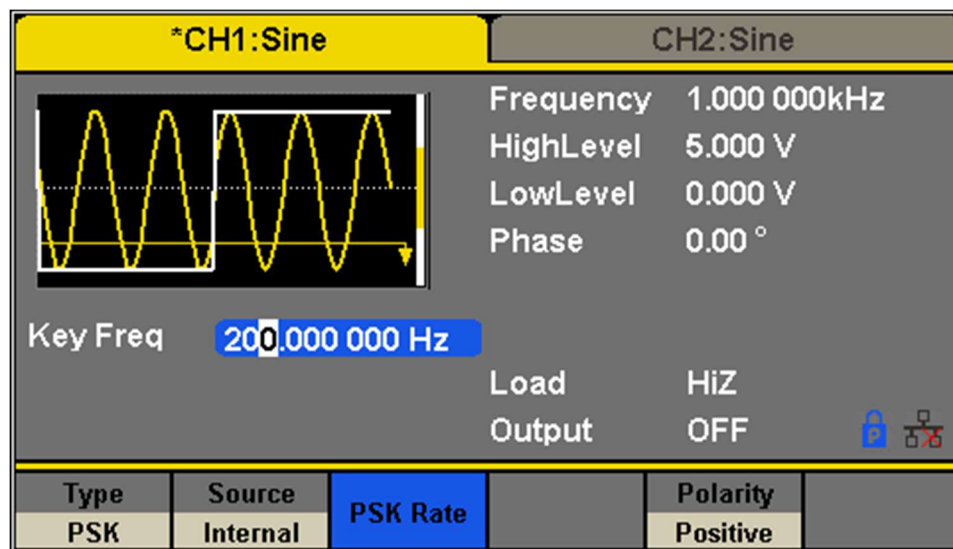

Figure 87 - Generate a PSK Modulation Waveform



### Example 15: Generate a PWM Modulated Waveform

Generate a PWM modulated waveform with 200 Hz key frequency. The carrier is a pulse wave with 5 kHz frequency.

- Set the frequency, amplitude and offset of the carrier wave.
  1. Press **Waveforms** and choose the Pulse waveform as the carrier wave
  2. Press **Frequency/Period** and choose **Frequency** which will display in a blue color. Input '5' from the keyboard and choose the unit 'kHz' to set the frequency to 5 kHz
  3. Press **Amplitude/HighLevel** and choose **Amplitude** which will display in a blue color. Input '5' from the keyboard and choose the unit 'Vpp' to set the amplitude to 5 Vpp.
  4. Press **Offset/LowLevel** and choose **Offset** which will display in a blue color. Input '0' from the keyboard and choose the unit 'Vdc' to set the offset to 0 V DC.
  5. Press **PulWidth/DutyCycle** and choose **PulWidth** which will display in a blue color. Input '40' from the keyboard and choose the unit 'us' to set the PulWidth (pulse width) to 40 us.
- Set the modulation type PWM and parameters.
  1. Press **Mod**. The message shown on the middle left side of the screen is 'PWM'.
  2. Press **PWM Freq**, input '200' from the keyboard and choose the unit 'Hz' to set the PWM frequency to 200 Hz.
  3. Press **Width Dev**, input '20' from the keyboard and choose the unit 'us' to set the width deviation to 20 us.

When all parameters above are set, the waveform generated is shown in Figure 88.

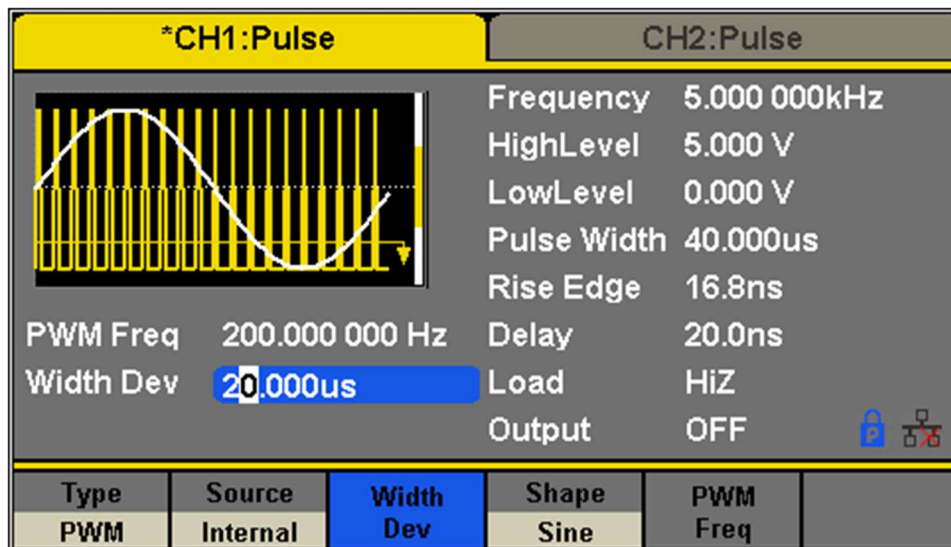

Figure 88 - Generate a PWM Waveform



### Example 16: Generate a DSB-AM Modulated Waveform

Generate a DSB-AM modulated waveform with 100 Hz modulating frequency. The carrier is a sine wave with 2 kHz frequency.

- Set the frequency, amplitude and offset of the carrier wave.
  1. Press **Waveforms** and choose the sine waveform as the carrier wave.
  2. Press **Frequency/Period** and choose **Frequency** which will display in a blue color. Input '2' from the keyboard and choose the unit 'kHz' to set the frequency to 2 kHz
  3. Press **Amplitude/HighLevel** and choose **Amplitude** which will display in a blue color. Input '4' from the keyboard and choose the unit 'Vpp' to set the amplitude to 4 Vpp.
  4. Press **Offset/LowLevel** and choose **Offset** which will display in a blue color. Input '0' from the keyboard and choose the unit 'Vdc' to set the offset to 0 V DC.
- Set the modulation type DSB-AM and its parameters.
  1. Press **Mod** → **Type** → **DSB-AM** and choose DSB-AM. The message shown on the middle left side of the screen is 'DSB-AM'.
  2. Press **DSB Freq**, input '100' from the keyboard and choose the unit 'Hz' to set the DSB Freq to 100 Hz.

When all parameters above are set, the waveform generated is shown in Figure 89.

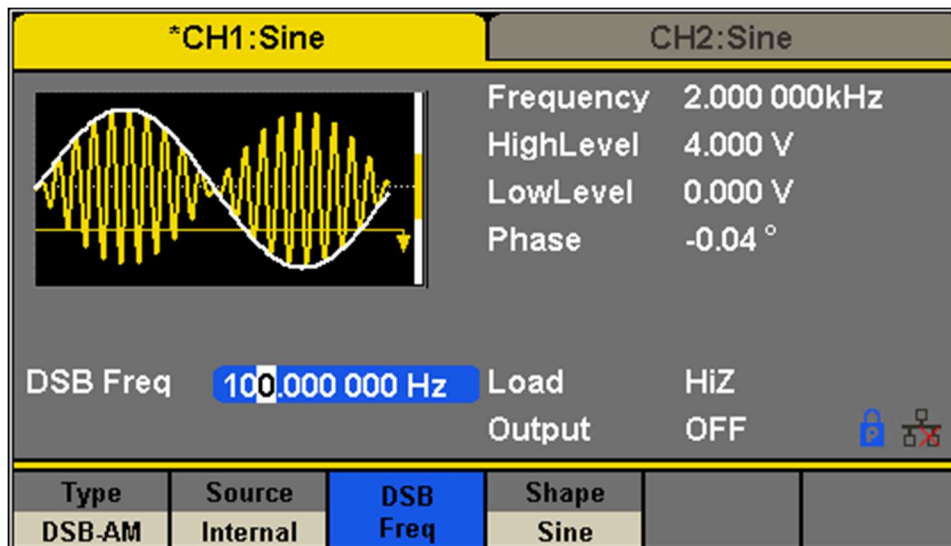

Figure 89 - Generate a DSB-AM Modulation Waveform

## Troubleshooting Guide

Below are some frequently asked questions and answers. Please check if any apply to your power supply before contacting B&K Precision.

### **Q: I cannot power up the generator**

- Check that the power cord is securely connected to the AC input and there is live power from your electrical AC outlet.
- Verify that the AC power coming from the mains is the correct voltage. The generator can accept a specific range of AC input voltages. Refer to section “2.1”.

### **Q: I cannot see any output out of the output terminals**

- Make sure that the **Output** buttons above channel 1 and/or channel 2 is lit. If not, press it once. The backlight of these **Output** buttons indicates that the respective channel’s output is enabled.

### **Q: I have connected my signal to an oscilloscope, but the amplitude is double of what I set**

- This is often because the impedance of the generator is not matched with the oscilloscope. When the generator is set to 50  $\Omega$  impedance, connecting it directly to an oscilloscope with a 1 M $\Omega$  input impedance will cause this to happen. To eliminate this issue, connect a 50  $\Omega$  terminator to the input of the oscilloscope, then connect a BNC cable between the generator and the terminator to have matching impedance.

# SPECIFICATIONS

Model	4053B	4054B	4055B
Channels	2		
<b>Frequency Characteristics</b>			
Sine & Square	1 $\mu$ Hz – 10 MHz	1 $\mu$ Hz – 30 MHz	1 $\mu$ Hz – 60 MHz
Triangle, Ramp	1 $\mu$ Hz – 500 kHz		
Pulse	1 $\mu$ Hz – 12.5 MHz		
Noise (-3 dB)	> 60 MHz		
Arbitrary	1 $\mu$ Hz – 6 MHz		
Accuracy	$\pm$ 25 ppm (1 year)		
Resolution	1 $\mu$ Hz		
<b>Arbitrary Characteristics</b>			
Built-in Waveforms	196 built-in waveforms (includes DC)		
Waveform Length	16k points / Ch		
Vertical Resolution	14 bits		
Sampling Rate	150 MSa/s		
Minimum Rise/Fall Time	6.5 ns (typical)		
Jitter (pk-pk)	8 ns (typical)		
Non-volatile Memory Storage	> 1000 16k points waveforms (100 MB in file system)		
<b>Output Characteristics</b>			
Amplitude Range	2 mVpp – 10 Vpp into 50 $\Omega$ (4 mVpp – 20 Vpp into open circuit), $\leq$ 10 MHz 2 mVpp – 5 Vpp into 50 $\Omega$ (4 mVpp – 10 Vpp into open circuit), > 10 MHz		
Amplitude Resolution	up to 4 digits		
Amplitude Accuracy (10 kHz sine)	$\pm$ (1 % + 1 mVpp)		
Amplitude Flatness	$\pm$ 0.3 dB (reference 10 kHz, 2.5 Vpp, 50 $\Omega$ oad )		
Cross Talk	< -60 dBc (both channels set to 0 dBm, sine 50 $\Omega$ load)		
Offset Range (DC)	$\pm$ 5 V into 50 $\Omega$ ( $\pm$ 0 V into open circuit)		
Offset Resolution	up to 4 digits		
Offset Accuracy	$\pm$ (  offset setting value  x 1% + 3 mV)		
Channel Output Impedance	50 $\Omega$ , high impedance		
Output Protection	Short-circuit protection		
<b>Waveform Characteristics (sine, square, triangle, ramp)</b>			
Harmonic Distortion (Sine)	DC – 10 MHz, < - 60 dBc / 10 MHz – 30 MHz < -45 dBc / 30 MHz – 60 MHz, < - 40 dBc (0 dBm input signal)		

Total Harmonic Distortion (Sine)	10 Hz – 20 kHz at 0 dBm, < 0.075%
Spurious (non-harmonic)	DC – 10 MHz, < -65 dBc / 10 MHz – 30 MHz, < -55 / 30 MHz – 60 MHz, < -40 (0 dBm input signal)
Rise/Fall Time (square)	< 4.2 ns (10% – 90%, at 1Vpp into 50 $\Omega$ )
Variable Duty Cycle (square)	0.001% - 99.999% (depending on frequency setting)
Asymmetry (50% duty cycle)	1% of period + 20 s (typical, 1 kHz, 1 Vpp)
Jitter (rms) cycle to cycle (square)	300 ps + 0.00 ppm of period (typical, 1 kHz, 1 Vpp)
Ramp Symmetry	0% – 100%
Linearity (triangle, ramp at 1 kHz, 1 Vpp, 100% symmetry)	< 1% of peak output (typical)
<b>General</b>	
<b>Pulse</b>	
Pulse Width	32.6 ns minimum, 100 ps resolution, 1,000,000 s max.
Rise/Fall Time	16.8 ns ( 1 Vpp, 50 10% – 90% 50 $\wedge$ load)
Duty Cycle	0.001% resolution
Overshoot	< 3 % (100 kHz, 1 Vpp)
Jitter (rms) cycle to cycle	300 ps + 0.05 ppm of period (typical, 1 kHz, 1 Vpp)
<b>Burst</b>	
Waveform	Sine, square, ramp, pulse, arbitrary, noise
Type	Cycle (1-1000000 cycles), infinite, gated
Start/Stop Phase	0° – 360°
Internal Period	1 $\mu$ s – 1000 s
Gated Source	Internal, external trigger
Trigger Source	Internal, external, manual
<b>Phase Offset</b>	
Range	0° – 360°
Resolution	0.1°
<b>AM, FM &amp; PM Modulation Characteristics</b>	
Carrier	Sine, square, ramp, arbitrary (except DC)
Source	Internal, external
Internal Modulation	Sine, square, ramp, noise, arbitrary (1 mHz - 20 kHz)
AM Modulation Depth	0% – 120%, 0.1% resolution
FM Frequency Deviation	0 – 0.5*bandwidth, 10 $\mu$ Hz resolution

PM Phase Deviation	0 – 360 °, 0.1 ° resolution
<b>ASK &amp; FSK Modulation Characteristics</b>	
Carrier	Sine, square, ramp, arbitrary (except DC)
Source	Internal, external
Modulation Waveform	50% duty cycle square waveform (1 MHz – 50 kHz)
<b>PWM Modulation Characteristics</b>	
Source	Internal, external
Modulation Waveform	Sine, square, ramp, arbitrary (except DC)
Internal Modulation	1 MHz – 20 kHz
<b>DSB-AM Modulation Characteristics</b>	
Carrier	Sine, square, ramp, arbitrary (except DC)
Source	Internal, external
Modulation Waveform	Sine, square, ramp, noise, arbitrary (1 MHz – 20 kHz)
<b>Sweep Characteristics</b>	
Waveforms	Sine, square, ramp, arbitrary (except DC)
Sweep Shape	Linear or logarithmic, up or down
Sweep Time	1 ms – 500 s
Sweep Trigger	Internal, external, manual
<b>Auxiliary Input / Output</b>	
Modulation Input	±6 Vpp (typical) for 100% modulation Maximum input voltage: 7 V Input impedance: 10 k Ω
Sync and Trigger Out	TTL compatible *1) Output impedance 100 Ω Maximum frequency: 1 MHz Minimum pulse width: 500 ns
Trigger In	TTL compatible *2) Input impedance: 10 k Ω Minimum pulse width: 100 ns Response time 100 ns (max) in sweep mode and 600 ns (max) in burst mode
<b>Reference Clock</b>	
Input	Frequency Range: 10 MHz ± 1 kHz (typical) Min. Voltage Input: 1.4 V 5 k Ω input impedance
Output	Frequency Range: 10 MHz ± 25 ppm (typical) Voltage Level: 3.3 V (typical), 2 V (minimum) 50 Ω output impedance

<b>Frequency Counter</b>	
Measurement	Frequency, period, duty cycle, positive/negative pulse width
Measurement Range	100 mHz – 200 MHz (DC coupling) 10 Hz – 200 MHz (AC coupling)
Input Range	100 mV to $\pm 2.5$ V (< 100 MHz, DC coupling)
Input Impedance	1 M $\Omega$
Coupling	AC, DC, HF, REJ
<b>Environmental and Safety</b>	
Temperature	Operating: 32 °F – 104 °F (0 °C – 40 °C) Storage: -4 °F – 140 °F (-20 °C – 60 °C)
Humidity	< 86° F (30 °C), $\leq 90$ % RH 104°F (40 °C), $\leq 50$ % RH
Altitude	Operating: Below 9,842 ft (3,000 m) Storage: Below 49,212 ft (15,000 m)
Electromagnetic Compatibility	EMC Directive 2004/108/EC, EN61326:2006, EN61000-3-2:2006+A2:2009, EN61000-3-3:2008
Safety	Low voltage directive 2006/95/EC, EN61010-1:2001, EN61010-
<b>General</b>	
Display	4.3" TFT-LCD display, 480 x 272
Interfaces	LAN & USBTMC (standard), GPIB (optional), USB host port
Storage Memory	Arbitrary waveforms and instrument settings share the same non-volatile storage
Power	100 – 240 VAC $\pm 10\%$ , 50 / 60 Hz
Power Consumption	50 W max.
Dimensions (W x H x D)	263 x 96 x 295 mm (10.3" x 3.78" x 11.6")
Weight	3.32 kg (7.32 lbs)
<b>Three-Year Warranty</b>	
Standard Accessories	Getting started manual, instruction manual (downloadable), AC power cord, USB type A-to-type B cable, certificate of calibration
Optional Accessories	USB-to-GPIB adapter (model AK40G)

1\*)  $V_{OH} = 3.8$  V ( $I_{OH} = -8$  mA),  $V_{OL} = 0.44$  V ( $I_{OL} = 8$  mA)

2\*)  $V_{IH} = 2$  V (min) / 5.5 V (max),  $V_{IL} = -0.5$ V (min) / 0.8 V (max)

## SERVICE INFORMATION

---

**Warranty Service:** Please go to the support and service section on our website at [www.bkprecision.com](http://www.bkprecision.com) to obtain a RMA #. Return the product in the original packaging with proof of purchase to the address below. Clearly state on the RMA the performance problem and return any leads, probes, connectors and accessories that you are using with the device.

**Non-Warranty Service:** Please go to the support and service section on our website at [www.bkprecision.com](http://www.bkprecision.com) to obtain a RMA #. Return the product in the original packaging to the address below. Clearly state on the RMA the performance problem and return any leads, probes, connectors and accessories that you are using with the device. Customers not on an open account must include payment in the form of a money order or credit card. For the most current repair charges please refer to the service and support section on our website.

Return all merchandise to B&K Precision Corp. with prepaid shipping. The flat-rate repair charge for Non-Warranty Service does not include return shipping. Return shipping to locations in North America is included for Warranty Service. For overnight shipments and non-North American shipping fees please contact B&K Precision Corp.

B&K Precision Corp.  
22820 Savi Ranch Parkway  
Yorba Linda, CA 92887  
[www.bkprecision.com](http://www.bkprecision.com)  
714-921-9095

**Include with the returned instrument your complete return shipping address, contact name, phone number and description of problem.**

## LIMITED THREE-YEAR WARRANTY

---

B&K Precision Corp. warrants to the original purchaser that its products and the component parts thereof, will be free from defects in workmanship and materials for a period of **three years** from date of purchase.

B&K Precision Corp. will, without charge, repair or replace, at its option, defective product or component parts. Returned product must be accompanied by proof of the purchase date in the form of a sales receipt.

To help us better serve you, please complete the warranty registration for your new instrument via our website [www.bkprecision.com](http://www.bkprecision.com)

**Exclusions: This warranty does not apply in the event of misuse or abuse of the product or as a result of unauthorized alterations or repairs. The warranty is void if the serial number is altered, defaced or removed.**

B&K Precision Corp. shall not be liable for any consequential damages, including without limitation damages resulting from loss of use. Some states do not allow limitations of incidental or consequential damages. So the above limitation or exclusion may not apply to you.

This warranty gives you specific rights and you may have other rights, which vary from state-to-state.

B&K Precision Corp.  
22820 Savi Ranch Parkway  
Yorba Linda, CA 92887  
[www.bkprecision.com](http://www.bkprecision.com)  
714-921-9095





22820 Savi Ranch Parkway

Yorba Linda, CA 92887

[www.bkprecision.com](http://www.bkprecision.com)

© 2017-2022 B&K Precision Corp.