

# **1672/1673 FC/1674 FC**

## Multifunction Tester

### Users Manual



6/2024 (English)

©2024 Fluke Corporation. All rights reserved.

Specifications are subject to change without notice.

All product names are trademarks of their respective companies.

## LIMITED WARRANTY AND LIMITATION OF LIABILITY

Each Fluke product is warranted to be free from defects in material and workmanship under normal use and service. The warranty period is 3 years and begins on the date of shipment. Parts, product repairs, and services are warranted for 90 days. This warranty extends only to the original buyer or end-user customer of a Fluke authorized reseller, and does not apply to fuses, disposable batteries, or to any product which, in Fluke's opinion, has been misused, altered, neglected, contaminated, or damaged by accident or abnormal conditions of operation or handling. Fluke warrants that software will operate substantially in accordance with its functional specifications for 90 days and that it has been properly recorded on non-defective media. Fluke does not warrant that software will be error free or operate without interruption.

Fluke authorized resellers shall extend this warranty on new and unused products to end-user customers only but have no authority to extend a greater or different warranty on behalf of Fluke. Warranty support is available only if product is purchased through a Fluke authorized sales outlet or Buyer has paid the applicable international price. Fluke reserves the right to invoice Buyer for importation costs of repair/replacement parts when product purchased in one country is submitted for repair in another country.

Fluke's warranty obligation is limited, at Fluke's option, to refund of the purchase price, free of charge repair, or replacement of a defective product which is returned to a Fluke authorized service center within the warranty period.

To obtain warranty service, contact your nearest Fluke authorized service center to obtain return authorization information, then send the product to that service center, with a description of the difficulty, postage and insurance prepaid (FOB Destination). Fluke assumes no risk for damage in transit. Following warranty repair, the product will be returned to Buyer, transportation prepaid (FOB Destination). If Fluke determines that failure was caused by neglect, misuse, contamination, alteration, accident, or abnormal condition of operation or handling, including overvoltage failures caused by use outside the product's specified rating, or normal wear and tear of mechanical components, Fluke will provide an estimate of repair costs and obtain authorization before commencing the work. Following repair, the product will be returned to the Buyer transportation prepaid and the Buyer will be billed for the repair and return transportation charges (FOB Shipping Point).

THIS WARRANTY IS BUYER'S SOLE AND EXCLUSIVE REMEDY AND IS IN LIEU OF ALL OTHER WARRANTIES, EXPRESS OR IMPLIED, INCLUDING BUT NOT LIMITED TO ANY IMPLIED WARRANTY OF MERCHANTABILITY OR FITNESS FOR A PARTICULAR PURPOSE. FLUKE SHALL NOT BE LIABLE FOR ANY SPECIAL, INDIRECT, INCIDENTAL OR CONSEQUENTIAL DAMAGES OR LOSSES, INCLUDING LOSS OF DATA, ARISING FROM ANY CAUSE OR THEORY.

Since some countries or states do not allow limitation of the term of an implied warranty, or exclusion or limitation of incidental or consequential damages, the limitations and exclusions of this warranty may not apply to every buyer. If any provision of this Warranty is held invalid or unenforceable by a court or other decision-maker of competent jurisdiction, such holding will not affect the validity or enforceability of any other provision.

Fluke Corporation  
6920 Seaway Blvd  
Everett, WA 98203  
U.S.A.

Fluke Europe B.V.  
P.O. Box 1186  
5602 BD Eindhoven  
The Netherlands

# Table of Contents

Title	Page
Introduction.....	1
Contact Fluke .....	1
Safety Information .....	2
Specifications .....	2
Radio Frequency Data.....	2
Features.....	3
Before You Start.....	4
Power Adapter/Charger .....	5
Li-ion Battery Pack .....	6
Safety Features .....	8
Live Circuit Detection.....	8
Earth Resistance Measurement .....	8
Safety Pretest.....	8
Mains Wiring Indicator.....	8
Rotary Dial and Pushbuttons.....	9
Touchscreen Display.....	11
Status.....	12
Menu Bar.....	12
Project Status.....	12
Measurement Screen.....	13
Rotary Screen.....	13
Menus.....	15
Device Settings Menu.....	15
System Settings .....	16
Memory Management .....	16
Date/Time Format .....	16
Localization.....	17
Battery Save Options.....	17
Display .....	18
Beeper .....	18
Communication Settings .....	18

Measurement Settings.....	19
Limits .....	19
Global Measurement Settings .....	20
Info .....	21
System Info.....	21
Ranges and Uncertainties .....	21
Licenses .....	21
Battery Info.....	22
Input Terminals.....	22
Warnings and Messages .....	24
How to Zero the Test Leads.....	24
Safety Pretest for Insulation Resistance Measurements .....	27
Measurements .....	28
Volts and Frequency Measurements.....	28
Insulation Resistance Measurement.....	30
Line Pair Setting .....	31
Safety Pretest .....	31
Test Voltage .....	31
Test Results .....	32
Continuity Measurement.....	32
Loop Impedance Measurement.....	33
No Trip Mode (Low Current) .....	33
Trip Mode (High Current) .....	36
Line Impedance.....	38
RCD Trip Time Measurement.....	40
Custom RCD Setting – Var mode .....	43
RCD Tripping Time in Auto mode .....	43
RCD Tripping Current Measurements.....	45
RCD Tests in IT Systems .....	47
Phase Rotation Tests.....	48
Earth Resistance Measurements (1673 FC and 1674 FC).....	49
Voltage Drop .....	50
SPD (1674 FC).....	51
IMD.....	52
Applications.....	53
How to Test a Mains Socket and Ring Installation.....	53
Earth Resistance Test by Loop Method .....	54
Zmax.....	55
Auto Start .....	55
Loop Impedance Test with 10 mA RCD.....	55
Preset Auto Test (1673 FC/1674 FC).....	56
Programmed Autotest Sequence (1674 FC).....	59

Form Mode .....	60
Create a Form .....	60
Create Client, Sites, and Projects .....	61
Client .....	61
Site .....	61
Project .....	62
Distribution Board .....	62
Circuits .....	62
Test Points .....	62
Select Project Form .....	63
How to Test from a Form .....	63
Review a Measurement .....	64
Clear Memory .....	64
Download Test Results .....	65
Fluke Connect™ Wireless System .....	66
TruTest™ Data Management Software .....	66
Firmware Updates .....	67
Maintenance .....	67
Battery Condition .....	68
Battery Replacement .....	68
Product Disposal .....	70



## Introduction

The Fluke 1672/1673 FC/1674 FC Multifunction Tester (the Product or Tester) is a battery-powered electrical installation tester. This manual applies to all models. All figures show the Model 1674 FC.

The Product measures and tests to:

- IEC 61557-1 General requirements
- IEC 61557-2 Insulation Resistance
- IEC 61557-3 Loop Impedance
- IEC 61557-4 Resistance of Earth and Bonding
- IEC 61557-5 Earth Resistance
- IEC 61557-6 RCD and Voltage Drop
- IEC 61557-7 Phase Sequence
- IEC 61557-8 Insulation Monitoring Devices for Insulated-Terra Power Distribution Network (IT Systems)
- IEC 61557-10 Combined Measuring Equipment

## Contact Fluke

Fluke Corporation operates worldwide. For local contact information, go to our website: [www.fluke.com](http://www.fluke.com).

To register your product, or to view, print, or download the latest manual or manual supplement, go to: [www.fluke.com/productinfo](http://www.fluke.com/productinfo).

+1-425-446-5500 [fluke-info@fluke.com](mailto:fluke-info@fluke.com)

## Safety Information

General Safety Information is in the printed Safety Information document that ships with the Product and at [www.fluke.com](http://www.fluke.com). More specific safety information is listed where applicable.

A **Warning** identifies hazardous conditions and procedures that are dangerous to the user. A **Caution** identifies conditions and procedures that can cause damage to the Product or the equipment under test.

## Specifications

Complete specifications are at [www.fluke.com](http://www.fluke.com). See the *1672/1673 FC/1674 FC Product Specifications*.

## Radio Frequency Data

### *Note*

*Changes or modifications to the wireless 2.4 GHz radio not expressly approved by Fluke Corporation could void the user's authority to operate the equipment.*

For complete information about radio frequency data, go to [www.fluke.com/manuals](http://www.fluke.com/manuals) and search for "Radio Frequency Data Class A".

The radio certification for a specific region is viewable on the Tester.

To view the radio certification labels, see the decal inside the battery compartment.



## Features

Table 1 is a list of features by model.

**Table 1. Measurement Features**

Measurement Feature	1672	1673 FC	1674 FC
Insulation Safety Pretest			●
Insulation at L-N, L-PE, N-PE	●	●	●
Auto Test Sequence		●	●
Loop/Line Resistance (mΩ resolution)			●
Continuity at L-N, L-PE, N-PE	●	●	●
Test Smooth DC Sensitive RCDs (Type B/B+)		●	●
Insulation Test Voltage range	250-1000 V	250-1000 V	50-1000 V
EV Test 6 mA for RCD A/EV, RDC-DD		●	●
Earth Resistance		●	●
Interface over BLE to communicate with Fluke Connect™		●	●
Interface over USB to communicate with TruTest	●	●	●
Zmax		●	●
Memory		●	●
Surge Protective Device (SPD)			●
Insulation Monitoring Device (IMD)			●
Autotest		●	●
Custom Autotest			●
Voltage Drop	●	●	●
RDC-DD Non-trip Loop		●	●
Other Features	1672	1673 FC	1674 FC
Fluke Connect™ Wireless System		●	●
TruTest™ Data Management Software compatibility	●	●	●
Leakage Current measurement with 1630-2 FC or 369 FC		●	●
Stakeless earth resistance measurement with 1630-2 FC		●	●

## Before You Start

Table 2 is a list of items included with the Tester. Use the model numbers to order additional components. Table 3 is a list of the mains cords.

**Table 2. Standard Equipment**

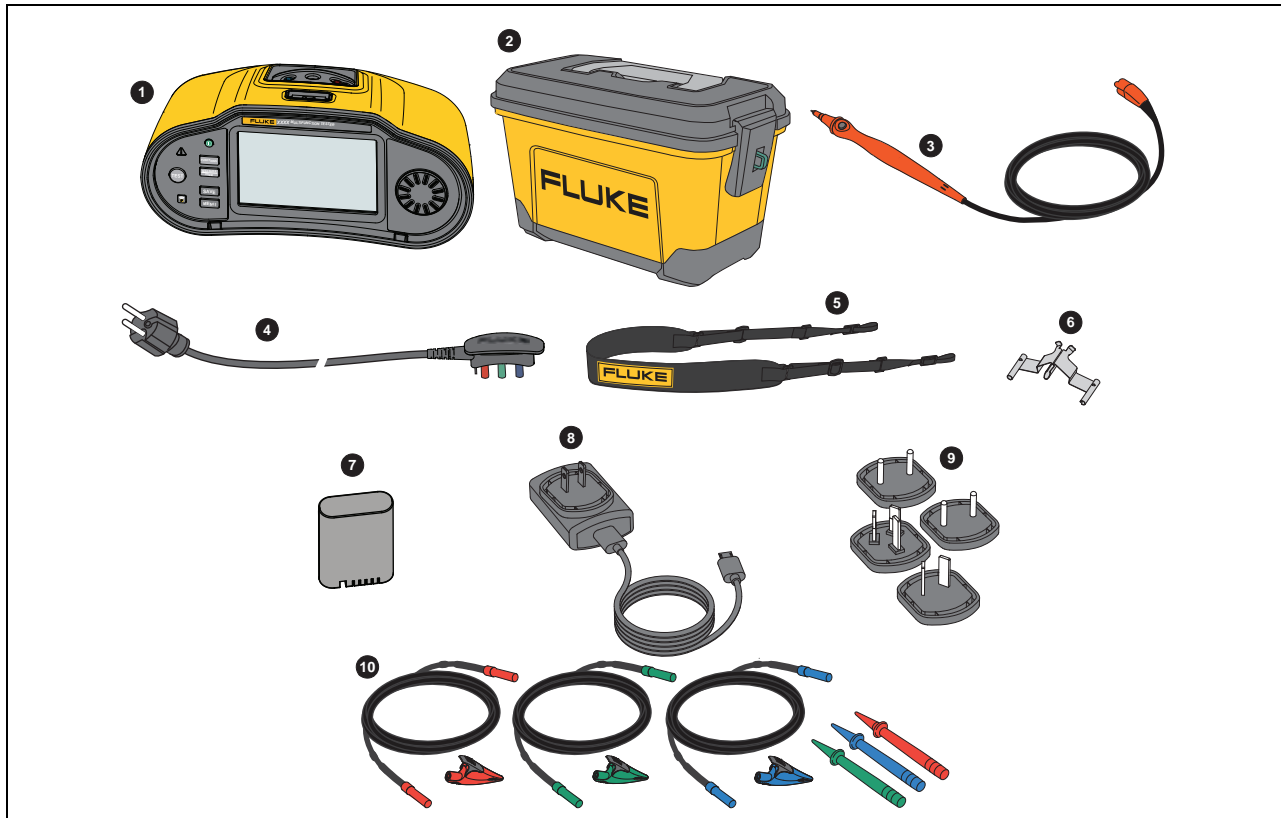

Item	Model Number	Description	Part Number
1	167x	Multifunction Tester	various
2	C1670	Hard Case Tool Box	5596336
3	TP165x	Remote Control Probe	2107742
4	---	Mains Test Cord (see Table 3)	---
5	---	Padded Neck Strap	4502043
6	---	Zero Adapter	3301338
7	BP290 (or equivalent)	Li-ion Battery	4025762
8	---	Power Supply, USB Type C	4938959
9	---	Universal Wall Mount <sup>[1]</sup>	4980734
10	TL165x	Test Lead Set	2107756

[1] Only included with shipments outside the U.S.

**Table 3. Country-Specific Mains Cord**

Mains Cord	Plug Type	Part Number
British	BS1363	4601070
Schuko	CEE 7/7	4601081
Denmark	AFSNIT 107-2-DI	4601129
Australia/New Zealand	AS 3112	4601118
Switzerland	SEV 1011	4601107
Italy	CEI 23-16/VII	4601096
USA	NEMA 5-15	4601134

Additional optional accessories are available for the Product. See [Table 4](#).

**Table 4. Optional Accessories**

Model Number	Description	Part Number
FTP165x/UK	Fused Test Probe	3989868
1630-2 FC	Earth Ground Clamp	4829532
369 FC	Leakage Current Clamp Meter	4709934
BP290	Li-ion Battery (spare)	4025762
ESBC290-1	External Battery Charger/Power Supply with Country-Specific Adapters	5385738
ES165x	Fluke Earth Spike Test Kit	2104706
TL1000/30M	30 m Reel Test Leads on Reel	5280031
FLK-TRUTEST-ADV	TruTest Data Management Software	5265319
167x Mag Grip	Magnet Hanger and Adapter (2 each)	6015416

## Power Adapter/Charger

The Product includes a 10 W USB-C charger for internal recharging of a depleted battery in <5 hours.

### *Note*

*USB-C quick charging is supported if you have the correct charger. Fluke does not supply this type of charger.*

The battery is also externally rechargeable with the optional external battery charger/power supply (ESBC290-1). See [Table 4](#). The battery compartment has easy access from the back of the Product. For more information, see [Battery Replacement](#).

Spare batteries are available from Fluke. See [Table 4](#).

## Li-ion Battery Pack

Recommendations for safe storage of battery pack:

- Do not remove a battery pack from its original packaging until required for use.
- When possible, remove the battery pack from the equipment when not in use.
- Fully charge the battery pack before storing it for an extended period to avoid a defect.
- After extended periods of storage, it may be necessary to charge and discharge the battery pack several times to obtain maximum performance.
- Keep the battery pack out of the reach of children and animals.

Recommendations for safe use of the battery pack:

- The battery pack must be charged before use. Use only Fluke approved power adapters to charge the battery pack. Refer to Users Manual for proper charging instructions.
- Do not leave a battery on prolonged charge when not in use.
- Do not subject battery packs to severe impacts such as mechanical shock.
- Keep the battery pack clean and dry. Clean dirty connectors with a dry, clean cloth. Take careful notice of correct placement of the battery in the product or the External Battery Charger.
- Never use a battery pack or charger showing visible damage.
- Alteration of battery pack: there shall be no attempt to open, modify, reform or repair a battery pack, which appears to be malfunctioning, or which has been physically damaged.
- Retain the original product information for future reference.

Recommendations to safe transport of battery packs:

- The battery pack must adequately be protected against short-circuit or damage during transport.
- Always consult the IATA guidelines describing safe air transport of Li-ion batteries.

To best maintain the battery:

- Replace the rechargeable battery after 5 years of moderate use or 2 years of heavy use.
- Moderate use is defined as recharged twice a week.
- Heavy use is defined as discharged to cutoff and recharged daily.

At delivery, install the battery in the Tester before use. The battery may be empty and must be charged for at least 5 hours (with the Tester turned off) to reach full charge. To charge the battery, install the battery and connect the power adapter. See [Figure 1](#). Turn off the Tester for a faster charge.

Before first use, set the date and time on the Tester. See [Date/Time Format](#). The date and time remains set when power is turned off or battery is replaced. You may need to reset the date and time if the battery is removed.

When battery power is used, the battery indicator at the top of the screen informs you about the condition of the batteries. For internal charging, the indicator is green. The indicator turns red when <1 hr of battery power remains. The fully charged battery lasts for an extended working day (10 hours).

The battery symbols are: .

 indicates that external power is connected and charging is in process.

**⚠ Caution**

**To prevent overheating of the battery during charging, do not exceed the allowable ambient temperature. See 1672/1673 FC/1674 FC Product Specifications at [www.fluke.com](http://www.fluke.com).**

*Note*

*No damage will occur if the power adapter is connected for long periods, for example, during the weekend. The instrument automatically switches to trickle charging.*

**Figure 1. Battery Charge with USB Power Supply**

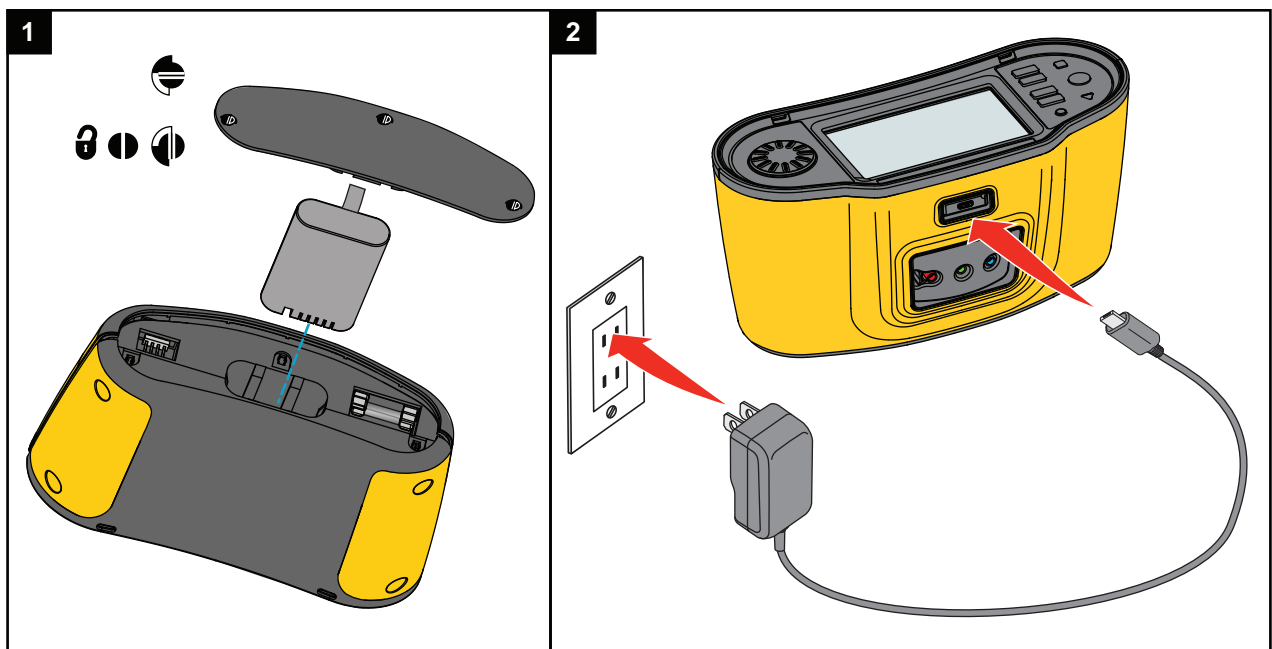

You may choose to use the external battery charger ESBC290-1 (optional Fluke accessory, see [Table 4](#)) and exchange the battery (optional Fluke accessory BP290) with a fully charged battery. See the *BP290 Battery Pack Instructions* for more information.

## Safety Features

Safety and performance are requirements for any electrical system. Good quality insulation, a properly working grounding system, and active protection ensure the safety of people, electrical systems, and buildings. These factors protect them against electrocution, fire, and other equipment damage.

### Live Circuit Detection

For continuity and insulation resistance measurements, the Product inhibits the test if the terminal voltage detected is >30 V ac/dc before the test starts. The beeper sounds continuously if this voltage is present.

### Earth Resistance Measurement

The Product inhibits the test if >10 V is detected between the test rods. For more information, see [Earth Resistance Measurements \(1673 FC and 1674 FC\)](#).

### Safety Pretest

The 1674 FC model includes a Safety Pretest feature that detects any appliance connected to the circuit under test. The Safety Pretest gives you a warning before you start a test and prevents damage to appliances from the test voltage. For more information, see [Safety Pretest for Insulation Resistance Measurements](#).

### Mains Wiring Indicator

The terminal diagram in the center of the display indicates if L-PE or L-N terminals are reversed. The Tester inhibits operation and generates a message that the input voltage is not between 100 V and 600 V. If the L-PE or the L-N terminals are reversed, the Tester inhibits the UK Loop and RCD tests.

When the Tester measures a high voltage between two wires, ⚡ shows on the display. See [How to Test a Mains Socket and Ring Installation](#) for more information.

## Rotary Dial and Pushbuttons

Use the rotary dial to select the test type. See [Table 5](#). Use the pushbuttons to control operation of the Tester, select test results to view, and scroll through test results.

**Table 5. Rotary Dial and Pushbuttons**











Item	Function	Description
<b>1</b>		Turn on and turn off the Tester: <ul style="list-style-type: none"> <li>• Green LED on and display on, Tester is ready to use</li> <li>• Green LED on and display off, Tester is in standby mode, press any button to wake up</li> <li>• Green LED off, display off, and USB cable connected, the Tester is charging (no indication on the Tester)</li> </ul> The Tester turns off automatically when inactive for the time period set by the user-adjustable timer. See <a href="#">Battery Save Options</a> .
<b>2</b>	Rotary Dial	Rotate left/right to move the highlight on the display. Push the center of the dial to make a selection.
<b>3</b>		Opens the selection screen for measurement functions.
<b>4</b>		Toggle between the measure mode and the form mode.

Table 5. Rotary Dial and Pushbuttons (cont.)

Item	Function	Description
5		Opens the Device Settings menu.
6		Save the measurement. While measurement is in process, this button is inactive. See <a href="#">Quick Save</a> .
7		1673 FC/1674 FC: Turn on the radio for Fluke Connect. Blinks in 5 s intervals when FC device is connected. Press for >1 s to turn off the radio.
8		Start the measurement test.
9		<p>Voltage warning. If the PE voltage is &gt;100 V, the  symbol illuminates if you push , the PE annunciator in the display is lit, and the beeper sounds. The Tester inhibits the RCD and Loop tests. Not valid for phase rotation measurements.</p> <p style="text-align: center;"><i>Note</i></p> <p><i>The voltage warning is inactive for phase rotation tests on three-phase systems or tests on Isolated Terra (IT) networks.</i></p>



# Touchscreen Display

The color display is a touchscreen that shows measurements and settings. This display is also operable when you wear safety gloves. Use the rotary dial to navigate through the interface or tap your finger on the screen to make a selection. Use the touchscreen to set up and adjust all the test parameters.

Table 6 is a list of the basic information areas on the display.



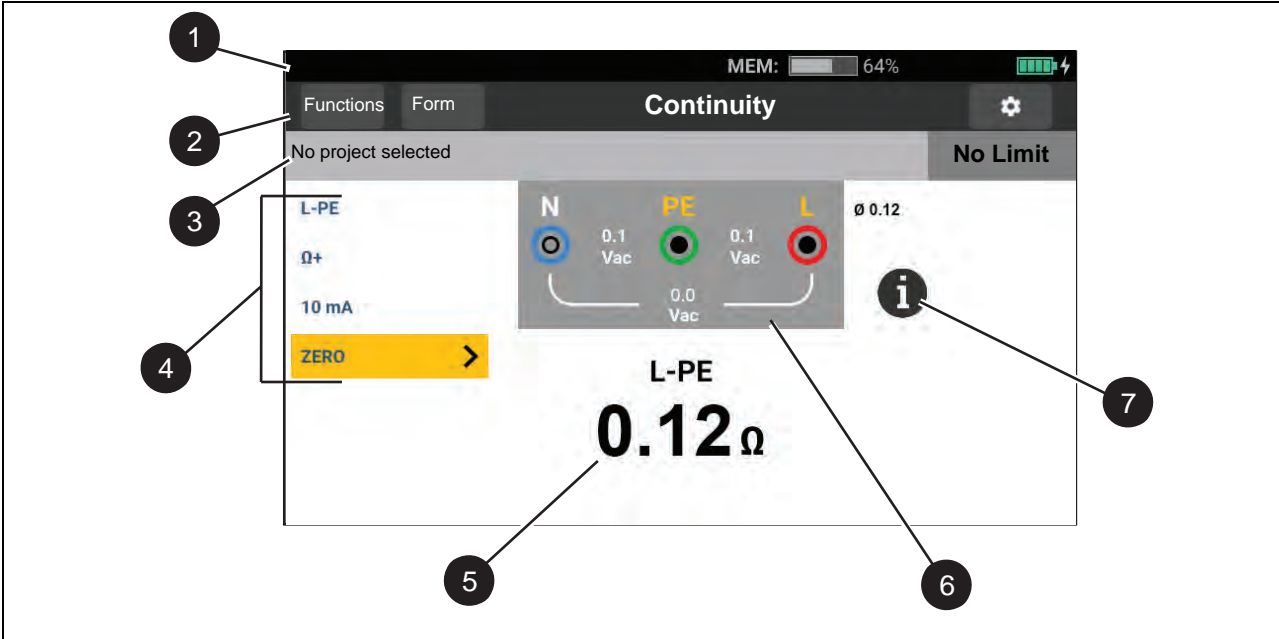
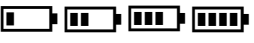

Table 6. Display





Item	Description
1	Status
2	Menu
3	Project Status
4	Adjustable Settings for measurements
5	Measurement Results
6	Terminal Diagram
7	Info icon: opens Connection Diagram with additional notes

## Status

The status bar is information about the Tester. This bar shows:

- Date and time: see [Date/Time Format](#)
- MEM: available memory, when more than 80 % is full, the icon is red
-  FC device is connected
-  shows a green checkmark when an FC mobile device is connected
-  battery usage, when <1 hr () of charge remains the icon turns red
-  charging in-progress, icon turns green

## Menu Bar

The menu bar shows on every screen (except the rotary and settings menu) and is a navigation option. When a measurement screen is selected, the display shows the currently selected measurement mode. Tap  and  to toggle the screen view.

## Project Status

The project status bar is information about the work in progress. This includes pass/fail status with the limit settings. It also shows details about the selected form and the measurement test type with the format:

**NAME\_OF\_FORM/DISTRIBUTION\_BOARD/CIRCUIT/TP**

If no project is selected, the status bar shows: **No project selected**

The pass/fail indication is based on the limits set when you create or upload the form. Green indicates **Pass** and red indicates **Fail**. For information on how to setup, see [Limits](#).

## Measurement Screen

The measurement screen shows all the information about the measurement that includes settings, results, and additional information.

In general, the measurement screen has:

- Single or multiple main readings: shows the parameters that are measured or tested, such as, voltage, current, and resistance.
- Multiple subreadings in a list: this measurement screen shows when four or more subreadings are associated with the measurement.

These subreadings are in a list format to provide the detailed information about each subreading.

- Interference level: specific to a Loop Impedance - NO Trip mode test measurement and shows the interference level associated with the circuit under test.

Tap **i** to view a connection diagram with information and special notes about the inputs.

## Rotary Screen

The rotary screen is the primary interface when you turn on the Tester to select the measurement function. You have options for how to view the rotary screen. One is horizontally aligned and animated. See [Figure 2](#). The other option is in a grid format. See [Figure 3](#). For information on how to set this option, see [Menus](#).

Figure 2. Rotary Screen

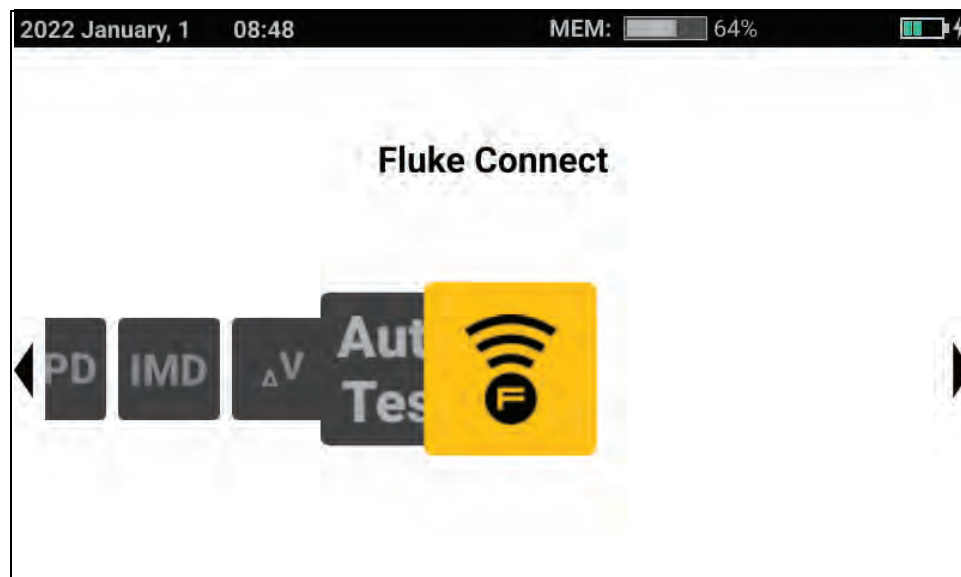
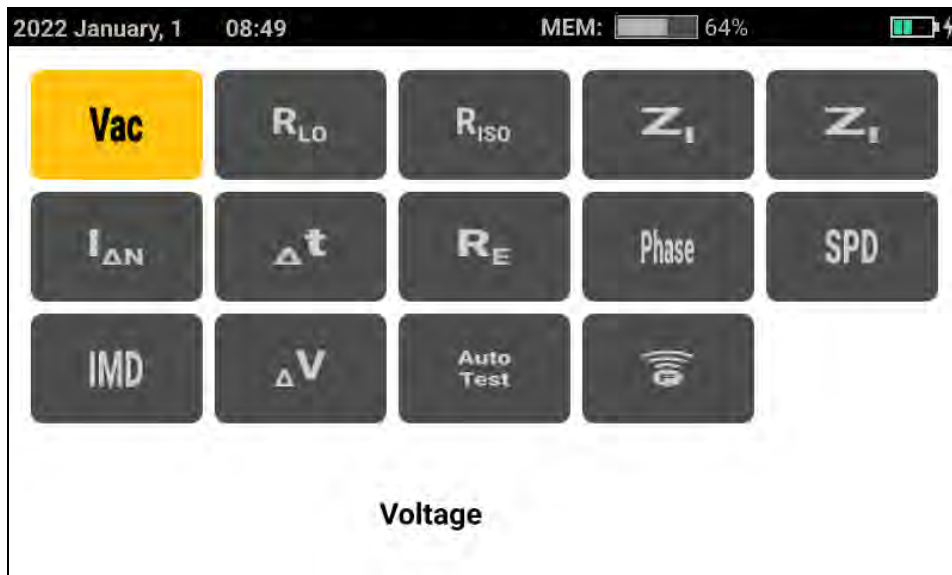

Figure 3. Grid Screen



You can use either the rotary dial or the grid to select the measurement mode.

To choose a measurement mode:

1. Tap the label for the measurement or rotate the rotary dial to highlight the label and push the center of the dial.

The display shows the selected function and the associated settings.

2. When you select **Auto Test**, the Auto Test page opens.

See [Preset Auto Test \(1673 FC/1674 FC\)](#).

## Menus



Tap  or push  to open the Main menu. From this menu you can select submenus for:

- Device Settings
- Projects
- Clients
- Templates

## Device Settings Menu

This menu has information and adjustable settings for the Tester:

- Measurement Settings
  - Limits
  - Global Measurement Settings
- System Settings
  - Memory Management
  - Date and Time
  - Localization
  - Battery Saving
  - Display
- Info
  - System info
  - Licenses
  - Ranges and Uncertainties
  - Battery Info
- Communication Settings
  - FC-devices

Tip: Use the touchscreen or the rotary dial to highlight and select options. To exit a menu, tap  to back through the menus. You can also use the rotary dial to highlight  and push center of the dial to go back through the menus.

## System Settings

The System Settings menu has options for how to set up the Tester with the preferences that best fit your work environment. The first time you turn on the Tester, the System Settings menu opens to let you set up the language, region, and date/time format.

### Memory Management

To manage the Tester memory:

1. Press  to open the Main Menu.
2. Go to **Device Settings > System Settings > Memory Management**.

The Tester shows a list of options:

- Remove all projects
- Remove all clients
- Remove all custom autotests
- Factory Reset

### Date/Time Format

The date and time is user-adjustable on the Tester. Before first use, set the date and time on the Tester. The date and time remains set when power is turned off or the battery is replaced. If battery is removed, you may need to reset the date and time.

The date format options include MM/DD/YYYY, DD/MM/YYYY, and YYYY/MM/DD. The time format is set as either 12-hour or 24-hour format.

To set:

1. Open the Device Settings Menu:
2. Highlight and select **System Settings**.
3. Highlight and select **Date and Time**.
4. Tap on an option to select.
5. Tap on the arrow buttons to change a field.
6. When all changes are done, push the center of the rotary dial to update and exit the menu.

## Localization

The language, region, and keyboard language selection is user-adjustable on the Tester. This setting is persistent and stays as-set when you remove the battery.

To set:

1. Open the Device Settings Menu:
2. Highlight and select **System Settings**.
3. Highlight and select **Localization**.
4. Highlight and select the options for **Language, Region, and Keyboard language**.

## Battery Save Options

To save battery power, you can set a timer to:

- Display dim
- Display off
- Instrument standby (low-power mode)
- Instrument off

To set:

1. Open the Device Settings Menu:
2. Highlight and select **System Settings**.
3. Highlight and select **Battery Save Options**.
4. Highlight and tap on the parameter or push the center of the rotary dial to open a selection menu.
5. Tap on the option to select.
6. Push the center of the rotary dial to close the menu and set the option or tap outside the menu to close with no change.

### Display

The Display menu has the options for:

- Display orientation
- Function screen type
- Display brightness

To set:

1. Open the Device Settings Menu:
2. Highlight and select **System Settings**.
3. Highlight and select **Display**.
4. Highlight the option and tap on the parameter or push the center of the rotary dial to make a change.
5. Tap  to exit the menu.

### Beeper

The Tester has an internal beeper that sounds a tone after each completed measurement. The beeper has two tones to indicate a positive or negative result. The positive tone is confirmation of a successful test. The negative tone is a warning to check the Tester or connections.



## Communication Settings

### FC-Devices (1673 FC/1674 FC)

The Tester can connect to both the 1630-2 FC Earth Ground Clamp and 369 FC Leakage Current Clamp Meter. When connected to these tools you can remotely view and save measurements.

Measurements from the paired tools can be seen in the FC Connect screen or in the case of the Fluke 1630-2 FC, also in the R<sub>E</sub> function.

To pair your device:

1. Push .
2. Select **Device Settings** > **Communication Settings** > **FC - Devices**.
3. Select and pair the device from the display.
4. Select  in the functions menu to go to the Fluke Connect screen.



## Measurement Settings

The Measurement Settings adjust the parameters for a measurement.

### Limits

Defining a limit allows you to set the pass, fail, and amber warning limits. Default limits are set according to the local standard. [Table 7](#) is a list of the default limits, where applicable.

*Note*

*Fluke recommends that you check the limits for local requirements before you start any tests.*

Loop test limits can be set in this screen, but these limits are overridden in Forms Mode by any circuit metadata (selected protection device) that you enter.

**Table 7. Default Limits**

Test Type	Setting	Limit
Voltage (by region)	230 V/120 V	±10 %
Continuity	NA	2 Ω
Loop (Protection Device) <sup>[1]</sup>	as selected	no default
Insulation	NA	1 MΩ
RCD Time	x1/2	should not operate
	x1	200 ms
	x5	40 ms
RCD Ramp	AC Type RCD	≤I <sub>ΔN</sub> x1
	A Type RCD	≤I <sub>ΔN</sub> x1.4
	B Type RCD	≤I <sub>ΔN</sub> x2
Voltage Drop	NA	4 %
SPD/IMD	NA	No limits: use manufacturer recommendations

[1] For Loop test type, set the % limit to show an amber warning when the limit is a defined % from a failure limit.

To adjust a limit:

1. Open the Device Settings Menu or tap the **Limit** field in the Measurement screen.
2. Highlight and select **Measurement Settings**.
3. Highlight and select **Limits**.

4. Highlight a parameter.

Tip: You can tap a parameter, rotate the dial, or swipe up and down to navigate through the Limits page.

Adjustable limits show in a white box.

5. Tap the white box to open a touchscreen keyboard.
6. Use the keyboard to input the limit.
7. Tap the display outside the keyboard to hide the keyboard and update the limit.

### Global Measurement Settings

Settings are adjustable to customize the test settings for a specific region. These settings are:

- System type
- Reference type
- Fault limit
- Polarity check
- Measurement frequency (Loop)
- Auto start RCD

#### System Type

This field allows for selection of local power supply system, to support TN-C-S, TT, and IT types of network topologies.

#### Reference Type

Choose the reference standard as **BS7671**, **IEC 61439**, or **Rest of world**.

#### Fault Limit

Select between 25 V and 50 V as the fault limit. The default value is 50 V.

#### Polarity Check

In several countries a fixed polarity check is required to pass the requirements. When enabled, this mode checks if the fixed polarity is correct and shows a warning if not correct.

In this mode, these tests are not performed when the polarity is not correct:

- Loop Trip
- Loop No Trip
- RCD Trip
- RCD Time

## Measurement Frequency (Loop)

Select between 0 Hz and 128 Hz.

## Auto Start RCD

Auto Start enables the test to automatically start for RCD Trip/Time and Loop Impedances modes. When a sufficiently high voltage is detected, the test automatically starts. The default setting is off.

## Info

### System Info

The System Info menu is where you find details about the Tester.

1. Select **System Info**.

The menu shows:

- Device Model
- Device serial number
- OS version
- UI version
- Libqueeg version
- MSP version
- Calibration date
- Calibration due
- Registration with QR Code

### Ranges and Uncertainties

For quick reference, the *Operating Ranges and Uncertainties* for standard EN 61557 are stored in the Tester. Highlight and select this option to view the limit values of the standard on the display.

### Licenses

Information about the software licenses are stored in the Tester.

1. Swipe up and down on the display to view the details.
2. Tap  to exit the menu.

## Battery Info

The Battery Info page has details about the installed battery:

- Serial Number
- Capacity
- Status
- Percentage
- Condition
- Time to empty
- Temperature

## Input Terminals

Table 8 is a list of the input terminals.

### **⚠⚠ Warning**

**To prevent possible electrical shock, fire, or personal injury, do not use test leads in CAT III or CAT IV environments without the protective cap installed. The protective cap decreases the exposed probe metal to <4 mm. This decreases the possibility of arc flash from short circuits. See Figure 4.**

Figure 4. Test Lead with Protective Cap

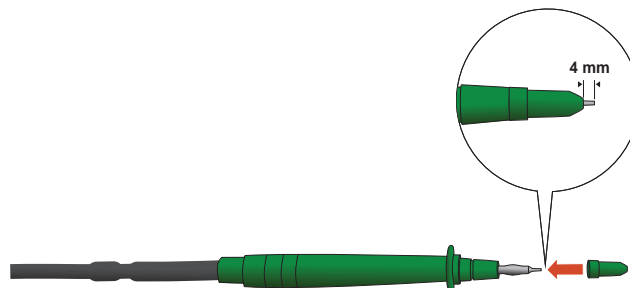

**Table 8. Input Terminals**

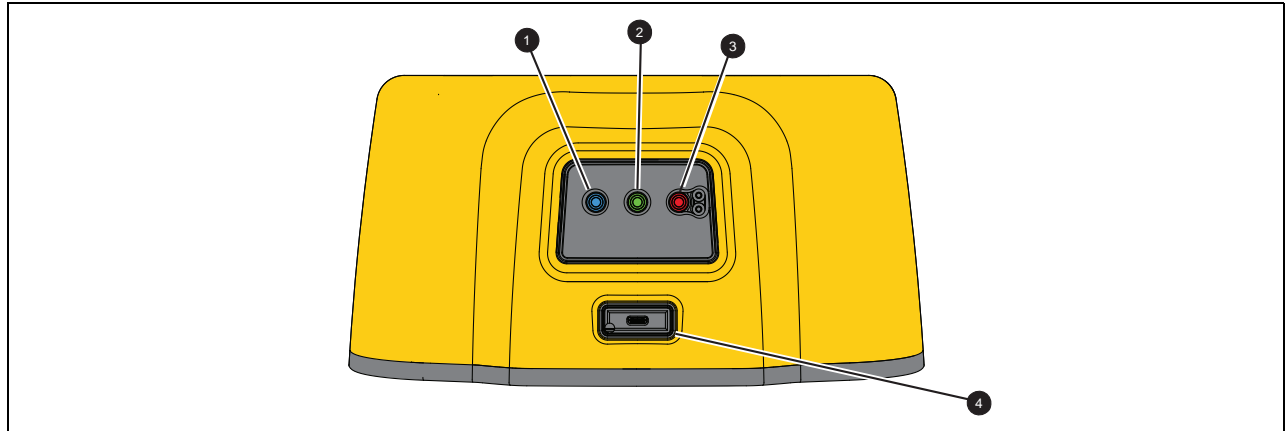

Item	Description
1	Blue Input N/L3/S (Neutral)
2	Green Input PE/L2/E (Protective Earth)
3	Red Input L/L1/H (Line)
4	USB-C Port

The USB-C port supports data-communication with a PC and internal battery charging.

You can connect the Tester to a computer and download the test data to *TruTest™ Data Management Software*. With the software, you can collect, organize, and display the test data in a format that meets your needs. See [Download Test Results](#) for additional information on using this port.

For more information about battery charging, see [Power Adapter/Charger](#) and [Figure 1](#).

## Warnings and Messages

The Tester detects various conditions and shows a message on the display. The messages have two categories: measurement warnings and system warnings. Measurement warnings are warnings that are visible on the measurement screen and give indication that something happened to the measurement.

The other category is system messages that occur with a popup to indicate a Tester problem. Most of these messages are critical.

For every warning there is an indication of the level. This could be informative, a warning, or an error. If an warning is critical, you cannot dismiss the warning. This warning continues to occur when you reboot the Tester. For example, if one of the fuses is broken, the Tester is not operable.

## How to Zero the Test Leads

Test leads have a small amount of inherent resistance that can affect a measurement. Before you do continuity or loop impedance tests, use the zero adapter to compensate for, or zero, the test leads or the mains cord.

The Tester maintains a separate zero value for each continuity range and loop impedance test. A unique zero is stored for each function. The  $\emptyset$  annunciator indicates when a zero value is stored for the selected lead combination. For each continuity range, zeros are valid for both polarities.

### *Note*

*Be sure the battery is in good charge condition before you zero the test leads.*

To zero:

1. Select **Z<sub>1</sub>** mode.
2. Connect the mains line cord (or the test leads) to the Tester and the zero adapter. See [Figure 5](#).

**Figure 5. Country-Specific Zero Adapter Configurations**

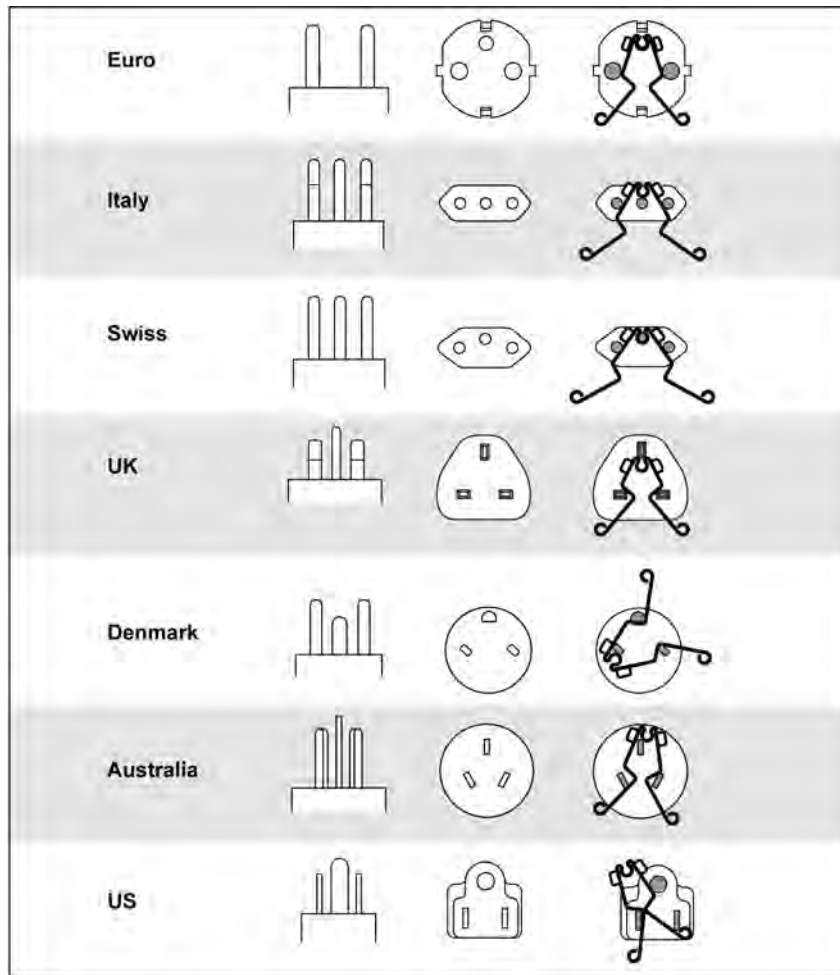

3. Tap **ZERO** (or navigate to **ZERO** with the rotary dial and push the center of the dial) to start the zero operation.

The  $\emptyset$  annunciator and the offset value show in the primary display.

The beeper sounds when zero value is complete. The Tester measures the lead resistance, stores the value, and subtracts it from readings. The resistance value is retained when you turn off the power. If the Tester is in the same function with the same test leads or mains cord, you do not need to repeat the zero operation.

If the display reads  $>3.0 \Omega$ , check that all 3 leads are connected and confirm  $\emptyset$  annunciator shows. Check for damaged leads. When the measurement has completed and no valid zero was detected, the zeros are cleared.

Tip: Tap **i** to see the connection diagram and more information on screen.

4. For  $R_{LO}$ , tap to select 10 mA or 250 mA range. A separate zero value is retained for each range.

- Connect the mains line cord (or the test leads) to the Tester and the zero adapter. You can zero two or three test leads in the  $R_{LO}$  function.
- Tap **ZERO** (or navigate to **ZERO** with the rotary dial and push the center of the dial) to start the zero operation.

∅ and the offset value show on the display. The beeper sounds with each completed zero value. See [Figure 6](#)

The Tester measures the lead resistance, stores the value, and subtracts it from measurements. The resistance value is retained when the power is turned off. If the Tester is set to the same function with the same test leads or mains cord, you do not need to repeat the zero operation.

**Figure 6. Zero Display**

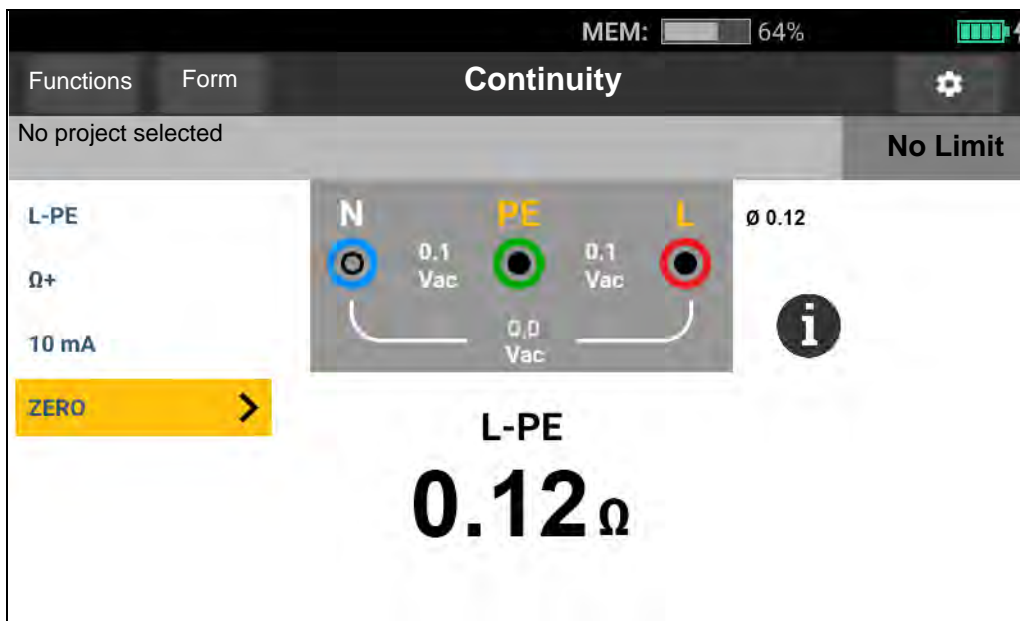

- If the display reads  $>3.0 \Omega$ :
  - For a Loop ( $Z_l$ ) test, check that all 3 leads are connected.
  - For a Continuity ( $R_{LO}$ ) test, check that all 3 leads are connected.
  - To zero 2 leads in the  $R_{LO}$  function, use L-PE, L-N, N-PE to select the shorted leads and confirm ∅ annunciator shows.
  - Check for damaged leads.

If the tester battery voltage is too low, the Tester will not zero.

If the Tester shows invalid values, reset the zero values:

- Hold the leads apart.

When the display reads  $>3.0 \Omega$  the ∅ annunciator disappears and clears the stored compensation value for that test.



## Safety Pretest for Insulation Resistance Measurements

The 1674 FC model includes the Safety Pretest feature that detects any appliances connected to the circuit under test. Safety Pretest gives you a warning before you start a test and prevents damage to appliances from the test voltage.

### ⚠ Caution

To use Safety Pretest, the Tester must be connected to the phase (red terminal), neutral (blue terminal), and protective earth line (green terminal). See [Figure 7](#). The Tester shows all three black dots in the terminal diagram to guide you. If you use the mains test cord at a mains socket, this condition is always true when the mains socket is wired correctly.

Figure 7. Connection for Safety Pretest

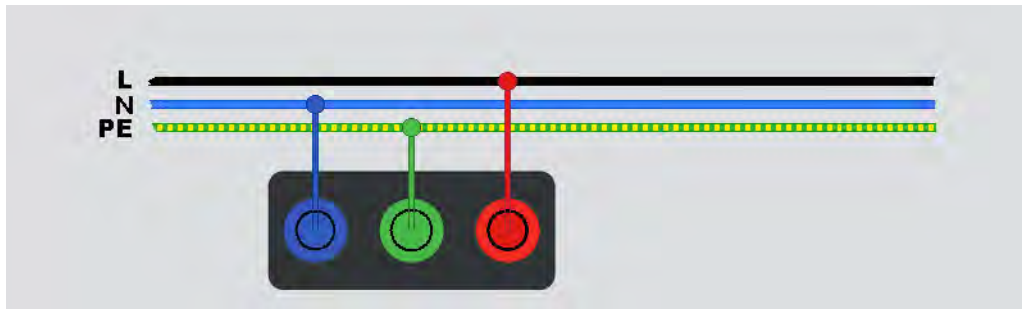

If the Tester detects that an appliance is connected, it will stop the insulation test.

To continue an insulation test and override the warning:

1. Select **Pretest** to turn off the pretest.
2. Disconnect any appliances that may still be connected to the circuitry.
3. Select **Pretest** again to detect and verify that all devices have been disconnected.

### Note

*Pay attention to electronically-controlled lighting systems and LED-lights that are connected semi-permanently.*

### ⚠ Caution

**If you override the Safety Pretest warning and continue, the test voltage can damage any connected appliance.**



To restart the pretest, select **Pretest** again.

## Measurements

This section has instructions for how to set up and use the Tester measurement functions.

**Quick Save.** Save test results from the function screen.

When you save a result, Quick Save assigns the results to a project consumer unit, circuit, or test point.

1. Select a function.
2. Connect the leads.
3. Adjust settings according to the measurement requirements.
4. Push .
5. Push .



The quick save screen prompts you for a project code followed by consumer unit designation, circuit designation, and test point designation.

### Note

*If the test is at the consumer unit, leave the circuit and test point designation blank. Or if at the circuit, leave the test point blank.*

**Form Save.** Save test results to a form created as part of a project.

Before you are able to use the Form Save function, see [Form Mode](#) for more information on how to create a form.

1. In the form table, highlight the cell for the test function and measurement point to test.
2. Push .
3. Adjust the settings to the measurement.
4. Push .
5. Push .

## Volts and Frequency Measurements

The volt mode measures the voltage across the leads. This mode shows all the voltages between line pairs L-PE, L-N, and N-PE. The sub-result provides the frequency of the power source.

The voltage mode has no setup settings. The results are automatically measured and there is no need to press **TEST**.

To measure voltage and frequency:

1. Select the **Voltage** mode. See [Figure 8](#).
2. Select any pair (red, blue, or green) of terminals for this test. You can use test leads or the mains test cord when you measure ac voltage.
  - The display shows the ac voltage for each pair. The Tester reads ac voltage  $\leq 660$  V. Higher voltages show as overload (OL).
  - The display shows the mains frequency below the ac voltage measurements.
  - Invalid test result shows as \_ \_ \_ on the display.
  - **i** is available in Volts mode to show a connection diagram.

**Figure 8. Volts and Frequency Measurement Screen**

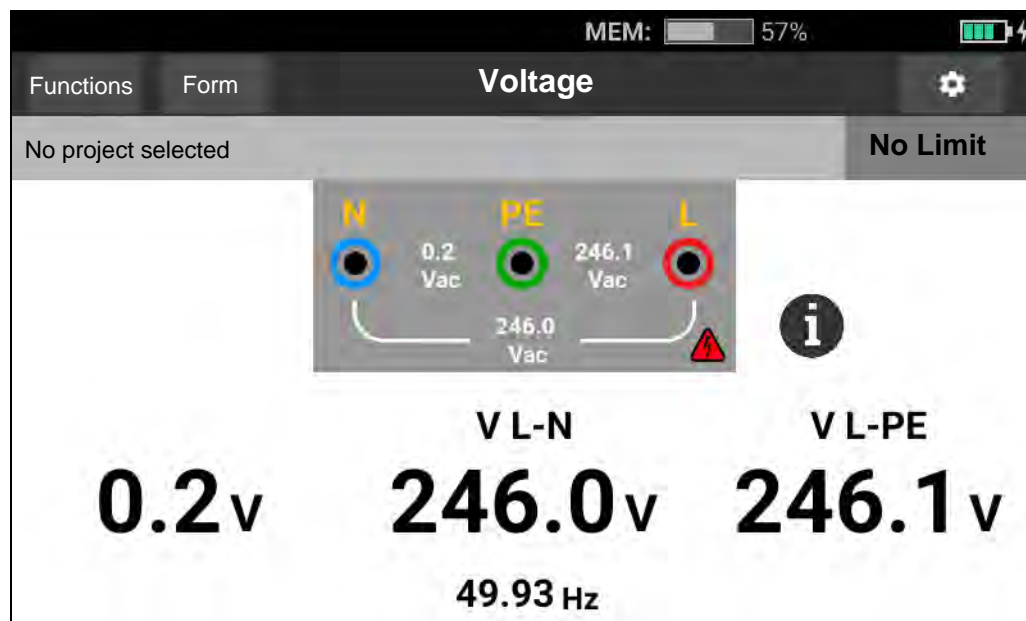

*Note*

*The displayed voltages are valid only if the selected test leads (including installation wires) are connected and not broken.*

## Insulation Resistance Measurement

### Warning

**To prevent electric shock, measurements should only be done on de-energized circuits.**

This measurement determines the insulation resistance ( $R_{iSO}$ ) between the selected line pair. No external voltage may be present on this line-pair to perform the test.

This measurement mode has various settings to adjust. The options are changing the line pair, enabling pretest, and test voltage adjustment.

To measure insulation resistance:

1. Select the **R<sub>ISO</sub>** mode. See [Figure 9](#).
2. Select the input.
3. Turn on or turn off the Safety Pretest.
4. Select the test voltage.

The selected test voltage also sets the measurement range and resolution.

5. To start the test, tap .

If voltage is detected on the line pair the test will not start and this message shows on the display:

** Voltage detected. Cannot start test.**

During the test the voltage level is visible in the terminal diagram as a reminder that high voltage is on the lead terminals. The Tester inhibits the test if the detected terminal voltage is >30 V ac/dc before the test starts. The beeper plays a negative sound if this voltage is present.

Figure 9. Insulation Resistance Measurement Screen

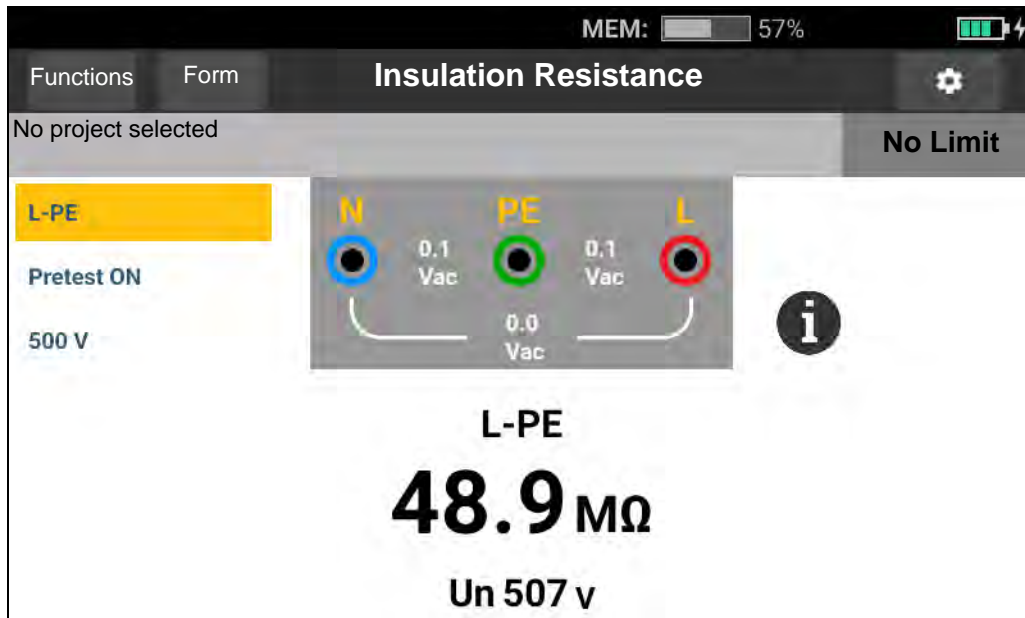

### Line Pair Setting

A test is made on any pair of two lines: L-N, L-PE, N-PE. The selected line pair shows above the reading. See Figure 9.

### Safety Pretest

#### ⚠ Caution

**Safety Pretest works reliably only when you have connected the L terminal to the phase, the N terminal to the neutral line, and the PE terminal to the PE line.**

#### Note

*For normal insulation with high resistance, the output voltage ( $U_A$ ) should always be equal to or higher than the programmed voltage. If not, check the Tester connections, leads, and fuses. If insulation resistance is low, the test voltage is automatically reduced to limit the test current to a safe level.*

### Test Voltage

The test voltage is selectable between 50 V (1674 FC only), 100 V, 250 V, 500 V and 1000 V. The default test voltage is 500 V.

## Test Results

The display shows the main result as resistance and the sub-result is the test voltage.

The resolution of the measurement depends on the test voltage set, for example, set to 100 V, the resolution is 100 k $\Omega$  and the measurement range is up to 100 M $\Omega$ . When the measurement is higher than the full range, the result shows as >100 M $\Omega$ . The limits are different for each selected test voltage. See *1672/1673 FC/1674 FC Product Specifications* at [www.fluke.com](http://www.fluke.com) for more information.

## Continuity Measurement

A continuity test is used to verify the integrity of connections with a high-resolution resistance measurement. This is important when you check Protective Earth connections. Measurements may be adversely affected by impedances, parallel circuits, or transient currents.

### Note

*If electrical circuits are laid out in a ring, Fluke recommends that you make an end-to-end check of the ring at the electrical panel.*

### Warning

**To prevent possible electrical shock, fire, or personal injury, measurements should only be done on de-energized circuits.**

To measure continuity:

1. Select the R<sub>LO</sub> mode. See [Figure 10](#).
2. Choose the test lead pair and use the appropriate terminals for this test.
3. Select if a measurement is for positive current ( $\Omega+$ ), negative current ( $\Omega-$ ), or both ( $\Omega+/-$ ).

This test type is for tests at the ring installation or to verify the connection between protective earth and neutral at a mains socket. To avoid tripping the RCD, use the 10 mA test current.

The + is positive current. The – is negative current. The  $\pm$  option gives the average between the positive and negative current results and shows in the center of the display. Choose the maximum test current. To not trip an RCD, use the 10 mA setting for a ring installation test that includes the neutral or phase wire.

Figure 10. Continuity Measurement Screen

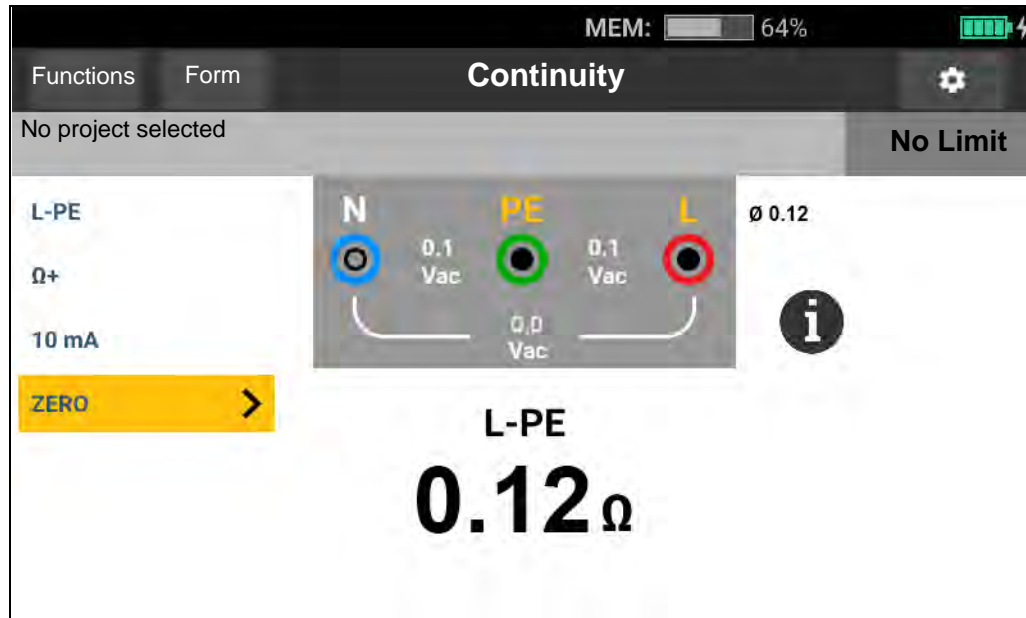

If a circuit is live, the Tester inhibits the test and this message shows on the display:

**⚠ Voltage detected. Cannot start test.**

## Loop Impedance Measurement

Loop impedance is source impedance measured between Line (L) and Protective Earth (PE). You can determine the Prospective Earth Fault Current (PEFC). PEFC is the current that could potentially flow if the phase conductor is shorted to the protective earth conductor. The Tester calculates the PEFC as the measured mains voltage divided by the loop impedance. The loop impedance function applies a test current that flows to earth. If RCDs are present in the circuit, they may trip. To avoid tripping, use the  $z_{1, \text{NO TRIP}}$  function.

### No Trip Mode (Low Current)

The no trip test applies a special low-current test that prevents RCDs in the system from tripping. If you are certain no RCDs are in the circuit, you can use the Trip Mode (High Current) function for a faster, more accurate, and less noise-sensitive test.

#### Note

*If the L and N terminals are reversed, the Tester will auto-swap them internally and continue the test. This condition is indicated by the terminal indicator symbols. If the Tester is configured for UK operation, L and N will not auto-swap and the test stops.*

Tips:

- Use the  $Z_I$  function for loop measurements.
- Preload conditions can cause the RCD to trip.
- An RCD with a nominal fault current of 10 mA will trip.
- To test loop impedance in a circuit with a 10 mA RCD, see [Loop Impedance Test with 10 mA RCD](#) section.
- Interference meter shows on the display.

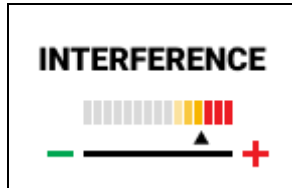

To measure loop impedance no trip mode for L-PE:

1. Select the  $Z_I$  function for Loop No Trip. See [Figure 11](#).
2. Select input.
3. Zero the test lead resistance offset.
4. Turn on or turn off Zmax.

Figure 11. Loop Impedance No-Trip Measurement Screen

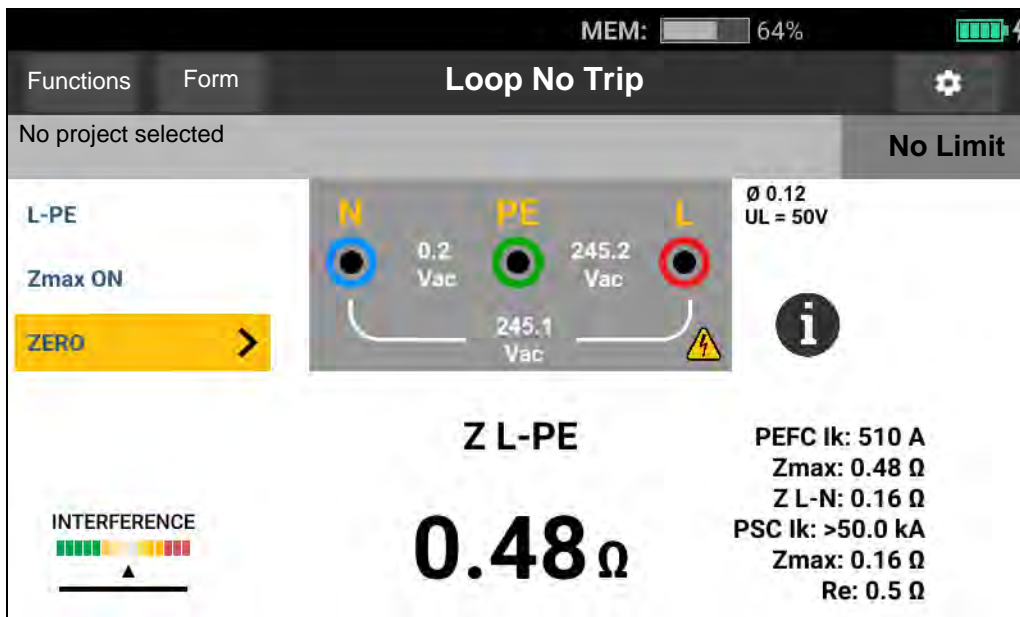



5. Select L-PE.
6. Connect and zero the test leads or mains line cord. For more information, see [How to Zero the Test Leads](#).
7. Tap **Zmax** to toggle the option on or off.

If Zmax is turned on, consecutive measurements are compared. The display shows the maximum  $Z_L$  (or  $Z_I$  for L-N) value until Zmax is turned off.

8. Connect all three leads to the L, PE, and N of the system under test or plug the mains test cord into the socket under test.

9. Tap .

If Auto Start is turned on, the test starts automatically as soon as the mains voltage is detected and the required test leads are connected.

10. Wait for the test to complete. The loop impedance shows on the display.

The Prospective Earth Fault Current appears in amperes or kiloamperes in the display.

This test will take several seconds to complete. If you disconnect the mains while the test is active, the test automatically stops.

#### Note

*Warnings can occur due to equipment on the circuit under test. If the measurement is noisy, the Interference Indicator will show red. If the Tester shows 0.00  $\Omega$ , consider that no perfect circuit exists. Check for correct lead connection to the Tester, leads are zeroed correctly, and fuse is good.*

### Trip Mode (High Current)

If no RCDs are present in the system under test, you can use the high-current Line Earth (L-PE) loop impedance test.

To measure loop impedance high-current trip mode:

1. Select the **Z<sub>l</sub>** function for Loop Trip. **Loop Trip** shows in the header to indicate that high-current trip mode is selected.
2. Connect the test leads to the terminals of the Tester or use the Mains Test Cord.

**Figure 12. Loop Impedance Trip Measurement Screen**

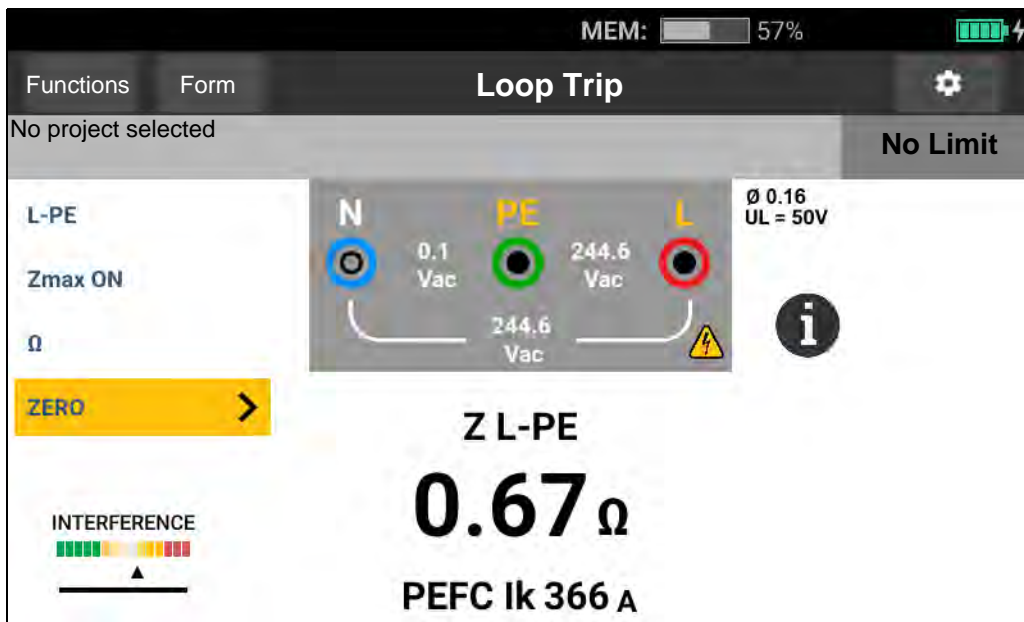

3. Select L-PE or L-N.
4. 1674 FC only, select between  $\Omega$  and  $m\Omega$  resolution for the test results. The  $m\Omega$  resolution test takes 30 seconds to 60 seconds to complete.
5. Zero the test leads. For a Loop ( $Z_l$ ) test, check that all 3 leads are shorted.

For more information, see [How to Zero the Test Leads](#).

6. For 1673 FC and 1674 FC only, tap **Zmax** to toggle the option on and off.

If Zmax is turned on, consecutive measurements are compared. The secondary display shows the maximum  $Z_L$  (or  $Z_I$  for L-N) value until Zmax is turned off. The Zmax value is saved when you save the test result. The Tester retains the Zmax value between the ZI No Trip and  $Z_I$  Hi Current tests.

7. Connect the leads to the L and PE of the system under test or connect the mains test cord to the socket under test.

The interference meter shows on the display.

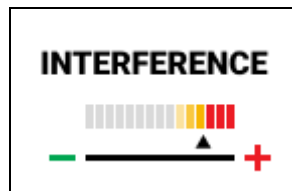

8. Tap **TEST**. If Auto Start is turned on, the test starts automatically as soon as the mains voltage is detected and the required test leads are connected.
9. Wait for the test to complete. The display shows the loop impedance.  
The Prospective Earth Fault Current (PEFC) appears in amperes or kiloamperes below the loop impedance measurement.
10. If Zmax is turned on, the Zmax value shows on the display.

**⚠⚠ Warning**

**To prevent possible electrical shock, fire, or personal injury, ensure there are no RCDs present. Any RCDs in the system will trip.**

*Note*

*The Tester may show a test result when the RCD is tripped if the trip time is >10 ms. Because of the short measurement, the test result does not meet the published specification. If the Tester shows 0.00  $\Omega$ , consider that no perfect circuit exists. Check for correct lead connection to the Tester, leads are zeroed, and fuse is good.*

## Line Impedance

Line impedance is source impedance measured between Line conductors or Line and Neutral.

This function allows these tests:

- Line to Neutral loop impedance.
- Line to Line impedance in 3-phase systems.
- L-PE loop measurement. This is a high-current, 2-wire loop measurement. It cannot be used on circuits protected by RCDs because it will cause them to trip.
- Prospective Short Circuit Current (PSC). PSC is the current that can potentially flow if the phase conductor is shorted to the neutral conductor or another phase conductor. The Tester calculates the PSC current as the measured mains voltage divided by the line impedance.

To measure line impedance:

1. Select the  $Z_{L-N}$  HI CURRENT mode. See [Figure 13](#).
2. Connect the red lead to the L (red) and the blue lead to the N (blue) terminals of the Tester.
3. Select L-N.
4. 1674 FC only, select between  $\Omega$  and  $m\Omega$  resolution for the test results. The  $m\Omega$  resolution test takes 30 seconds to 60 seconds to complete.
5. Zero the test leads. For more information, see [How to Zero the Test Leads](#).

Figure 13. Line Impedance Measurement Screen

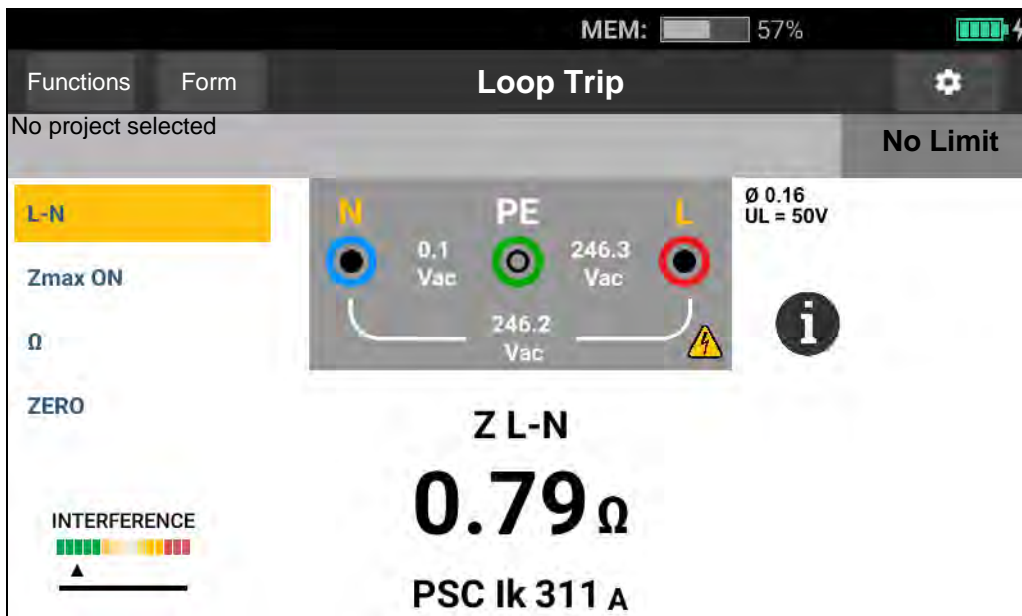

6. Tap **Zmax** to toggle the option on and off.

If Zmax is turned on, the Tester compares consecutive measurements. The display shows the maximum  $Z_L$  (or  $Z_I$  for L-N) value until Zmax is turned off. The Zmax value is saved when you save the test result.

*Note*

*RCDs in the system will trip if you use L-PE.*

7. Connect the leads in a single-phase test to the system live and neutral. To measure line-to-line impedance in a 3-phase system, connect the leads to two phases.
8. Tap **TEST**. If Auto Start is turned on, the test starts automatically as soon as the mains voltage is detected and the required test leads are connected.

Wait for the test to complete:

- The display shows the line impedance.
- The display shows the Prospective Short Circuit Current (PSC).
- If Zmax is turned on, the Zmax value shows on the display.

Use the connection shown in [Figure 14](#) for a 3-phase up to 600 V system measurement.

**Figure 14. 3-Phase System Measurement**

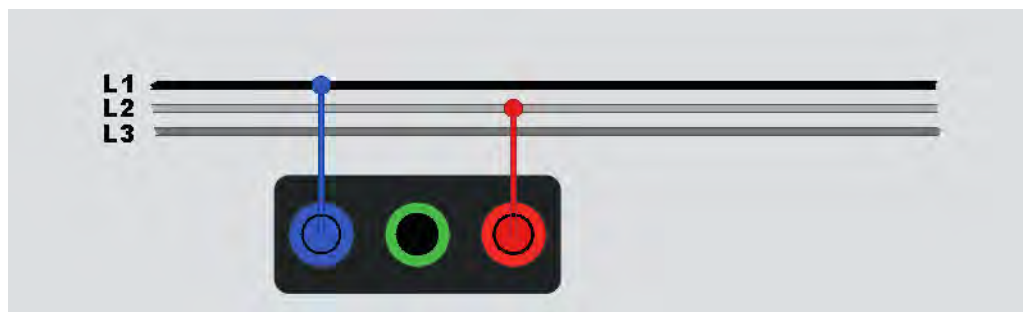

## RCD Trip Time Measurement

In this test, a calibrated fault current is induced into the circuit to cause the RCD to trip. The Tester measures and shows the time required for the RCD to trip. You can do this test with test leads or the mains cord. The test is done on a live circuit.

You can use the Tester to do the RCD tripping time test in Auto Start and make it easier for one person to do the test. If the RCD has a special nominal current setting other than the standard options, 10, 30, 100, 300, and 500, or 1000 mA, you can use a custom setting with the Var mode.

This test is done on a live circuit. If no voltage is detected, the Tester inhibits the test and this message shows on the display:

**⚠ No voltage detected. Cannot start test.**

### Note

*When you make trip time measurements for any type of RCD, the Tester first determines if the actual test will cause a fault voltage exceeding the limit (25 V or 50 V) and shows a warning message on the display.*

*To avoid an inaccurate trip time for S type (time delay) RCDs, a 30-second delay is activated between the pretest and the actual test. This RCD type needs a delay because it contains RC circuits that are required to settle before applying the full test.*

RCD type B, B+ or S-type B, B+ are actually two RCDs, one with type A/AC behavior and one with type B. The type B RCD is correctly tested only with the trip current (ramp) test. For trip time measurements, even with type B selected, the ac part of the RCD might cause the tripping because of the initial step of the test current. Fluke recommends that you do a trip current test with type B and a test with type A/AC waveform.

### ⚠⚠ Warning

**To prevent possible electrical shock, fire, or personal injury:**

- **Test the connection between the N-conductor and earth before you start the test. A voltage between the N-conductor and earth may influence the test.**
- **Leakage currents in the circuit that follow the residual current protection device may influence measurements.**
- **The displayed fault voltage relates to the rated residual current of the RCD.**
- **Potential fields of other earthing installations may influence the measurement.**
- **Equipment (motors, capacitors) connected downstream of the RCD may cause considerable extension of the tripping time.**

Note

If the L and N terminals are reversed, the Tester automatically swaps them internally and continues tests. If the Tester is configured for UK operation, tests will stop and you must determine why the L and N are swapped. The terminal indicator icons indicate this condition.

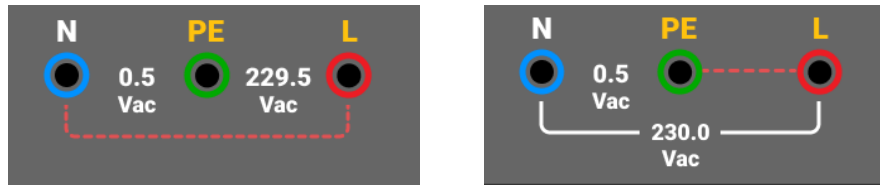

Type A and type B RCDs do not have the 1000 mA option available. Type B RCDs do not have the Var option available. When testing under a condition that would trip an RCD, but does not (for example, reading is >310 ms), check the connections, leads, and fuses.

To measure RCD tripping time:

1. Select the  $\Delta T$  RCD - Trip TIME mode. See [Figure 15](#).

Figure 15. RCD Trip Time Measurement Screen

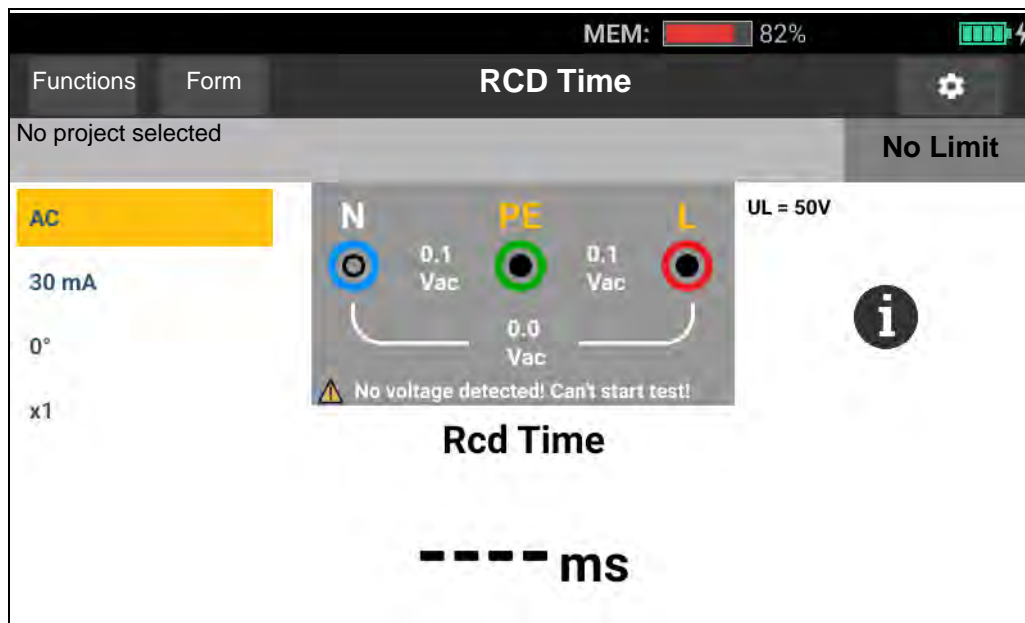

2. Select RCD test polarity: 0° or 180°.
3. Select RCD current multiplier: x1/2, x1, x5, or Auto.

4. Select RCD current setting: 10 mA, 30 mA, 100 mA, 300 mA, 500 mA or Var.
5. Tap **TEST**.
6. Select the RCD current setting (10, 30, 100, 300, 500, or 1000 mA).
7. Select a test current multiplier (x ½, x 1, x 5, or Auto). Normally you will use x 1 for this test.
8. Select the RCD type. See [Figure 16](#).

**Figure 16. RCD Type Selection**

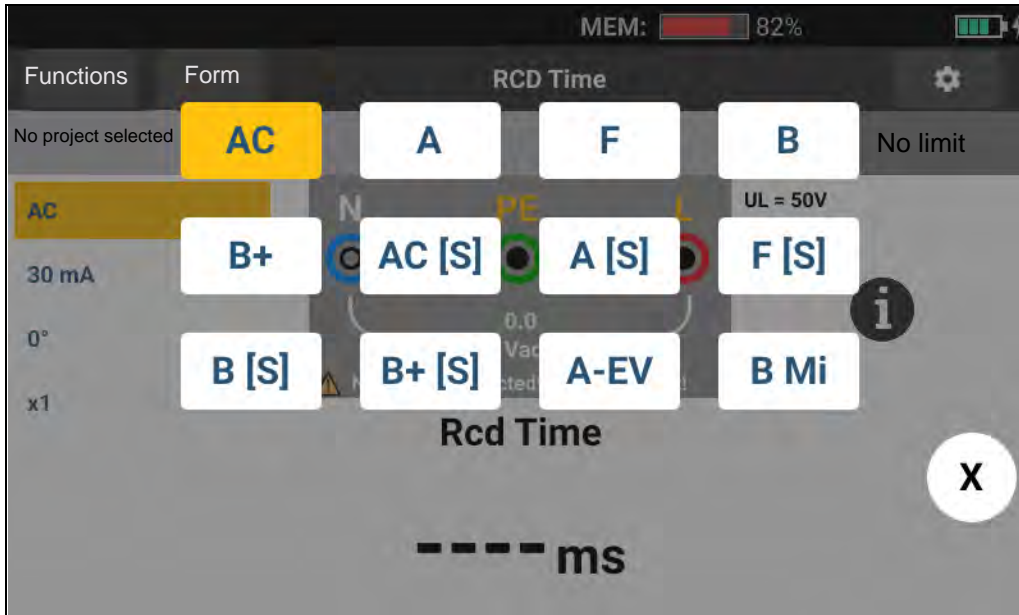

- AC current to test type AC (standard AC RCD) and type A (pulse-DC sensitive RCD)
- Half-wave current to test type A (pulse-DC sensitive RCD)
- Delayed response to test S-type AC (time delayed AC RCD)
- Delayed response to S-type A (time delayed pulse-DC sensitive RCD)

### 1673 FC/1674 FC

- Smooth-DC current to test type B RCD
- Delayed response to S-type B (time delayed smooth-DC current RCD)

#### Note

For type G, K or R RCDs, choose type A (half-wave current). Pass is not triggered on the short delay of 10 ms of the G, K, and R types. These types need a trip time of at least 10 ms.

Type B+ RCDs are tested with type B smooth dc-current.



9. Select the test current phase, 0° or 180°. Test the RCDs with both phase settings, as the response time can vary significantly.

*Note*

*For RCD type B or S-type B, you must test with both phase settings.*

10. At a minimum, connect the leads to L and PE of the system under test, or plug the mains test cord into the socket under test.

*Note*

*For RCD type B or S-type B all three test leads are required.*

11. Push .

If Auto Start is turned on, the test starts automatically as soon as the mains voltage is detected and the required test leads are connected.

12. Wait for the test to complete:
  - The primary display shows the trip time.
  - The secondary display shows the fault voltage (voltage drop on PE wire) related to the rated residual current.
  - If the trip time meets the appropriate standard of the RCD, the limit indicator shows **PASS**. For more information, see the *1672/1673 FC/1674 FC Product Specifications* at [www.fluke.com](http://www.fluke.com) for the RCD Tripping Time table.

### Custom RCD Setting – Var mode

To measure RCD tripping time for a custom RCD setting – Var mode:

1. Turn the rotary dial to the  $\Delta T$  (or  $I_{\Delta N}$  for Tripping Current measurement) position.
2. Select the Var current rating. The current custom setting shows on the primary display. You can adjust the value.
3. Select a test current multiplier. Normally, use x 1/2 or x 1 for this test.
4. Repeat steps 4 through 7 listed in the RCD tripping time measurement procedure.

*Note*

*The maximum setting for type A RCDs is 700 mA.*

### RCD Tripping Time in Auto mode

To measure RCD tripping time in Auto mode:

1. Plug the Tester into the outlet.
2. Select  $\Delta T$ .
3. Select the RCD type.

4. Select the RCD current rating (10 mA, 30 mA, or 100 mA).
5. Select Auto mode.
6. Select the RCD test-current waveform.
7. At a minimum, connect the leads to L and PE of the system under test, or plug the mains test cord into the socket under test.

*Note*

*For RCD type B or S-type B all three test leads are required.*

8. Push . If Auto Start is turned on (see [Measurement Settings](#)), the test starts automatically as soon as the Tester detects the mains voltage and the required test leads are connected.

The Tester supplies ½x the rated RCD current for 310 ms or 510 ms (2000 ms in the UK). If the RCD trips, the test terminates. If the RCD does not trip, the Tester reverses phase and repeats the test. The test terminates if the RCD Trips.

If the RCD does not trip, the Tester restores the initial phase setting and supplies 1x the rated RCD current. The RCD should trip and the test results appear in the primary display.

9. Reset the RCD.

The Tester reverses phases and repeats the 1x test. The RCD should trip and the test results appear in the primary display.

10. Reset the RCD.

The Tester restores the initial phase setting and supplies 5x the rated RCD current for up to 50 ms. The RCD should trip and the test results appear in the primary display.

11. Reset the RCD.

The Tester reverses phase and repeats the 5x test. The RCD should trip and the test results appear in the primary display.

12. Reset the RCD.

The test results show in a table on the display. If the trip time meets the appropriate standard of the RCD, the limit indicator shows. For more information, see the [1672/1673 FC/1674 FC Product Specifications](#) at [www.fluke.com](http://www.fluke.com) for the RCD Tripping Time table.

*Note*

*Test results are in temporary memory.*

13. To store all test results, push  and proceed as described in the [Quick Save](#) or [Form Mode](#) section of this manual.

## RCD Tripping Current Measurements

This test measures the RCD tripping current as you apply a test current and then gradually increase the current until the RCD trips. You can use the test leads or mains test cord for this test.

*Note*

*For RCD type B or S-type B all three test leads are required.*

### ⚠⚠ Warning

**To prevent possible electrical shock, fire, or personal injury:**

- **Test the connection between the N-conductor and earth before you start the test. A voltage between the N-conductor and earth may influence the test.**
- **Leakage currents in the circuit that follows the residual current protection device may influence measurements.**
- **The displayed fault voltage relates to the rated residual current of the RCD.**
- **Potential fields of other earthing installations may influence the measurement.**

If the L and N terminals are reversed, the Tester automatically swaps them internally and continues tests. If the Tester is configured for UK operation, tests stop and you must determine why the L and N are swapped. The terminal indicator icons indicate this condition.

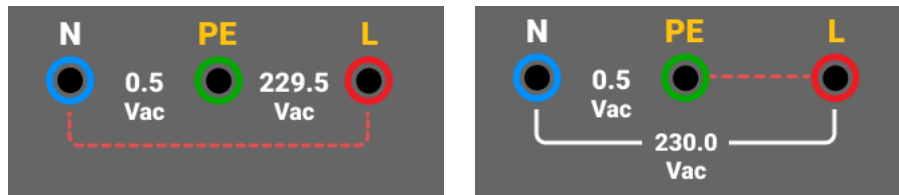

To measure RCD tripping current:

1. Select the  $I_{\Delta N}$  mode.
2. Select the RCD current rating (10, 30, 100, 300, 500, 1000 mA). If the RCD has a special nominal current setting other than the standard options, use a custom setting with the Var mode.
3. Select the RCD type:
  - AC current to test type AC (standard AC RCD) and type A (pulse-DC sensitive RCD)
  - Half-wave current to test type A (pulse-DC sensitive RCD)
  - Delayed response to test S-type AC (time delayed AC RCD)
  - Delayed response to S-type A (time delayed pulse-DC sensitive RCD)

### 1673 FC/1674 FC:

- Smooth-DC current to test type B RCD
- Delayed response to S-type B (time delayed smooth-DC current RCD)

*Note*

*For type G, K or R RCDs, choose type A (half-wave current). The limit indicator does not consider the short delay of 10 ms of the G, K and R types. These types need a trip time of at least 10 ms.*

4. Select the test current phase, 0 ° or 180 °. Test RCDs with both phase settings, as their response time can vary significantly.

*Note*

*For RCD type B (🔌) or S-type B (🔌🔌S), test with both phase settings.*

5. At a minimum, connect the leads to L and PE of the system under test, or plug the mains test cord into the socket under test.

*Note*

*For RCD type B (🔌) or S-type B (🔌🔌S) all three test leads are required.*

6. Push and release . If Auto Start is turned on, the test starts automatically as soon as the mains voltage is detected and the required test leads are connected.

Wait for the test to complete:

- The primary display shows the RCD trip current.
- The secondary display shows the fault voltage (voltage drop on PE wire) related to the rated residual current.
- If the trip current and the trip time (Type A / AC RCDs only) meets the appropriate standard of the RCD, the limit indicator shows on the display. For more information, see the *1672/1673 FC/1674 FC Product Specifications* for the RCD Tripping Time table.

To customize the RCD tripping current measurement, see [Custom RCD Setting – Var mode](#).

## RCD Tests in IT Systems

RCD tests at locations with Insulated-Terra Power Distribution Network (IT Systems) require a special test procedure because the Protective Earth connection is grounded locally and is not tied directly to the power system.

The test is done at the electrical panel with probes. See [Figure 17](#) for the connections used in this test.

**Figure 17. Connection for RCD Test on IT Electrical Systems**

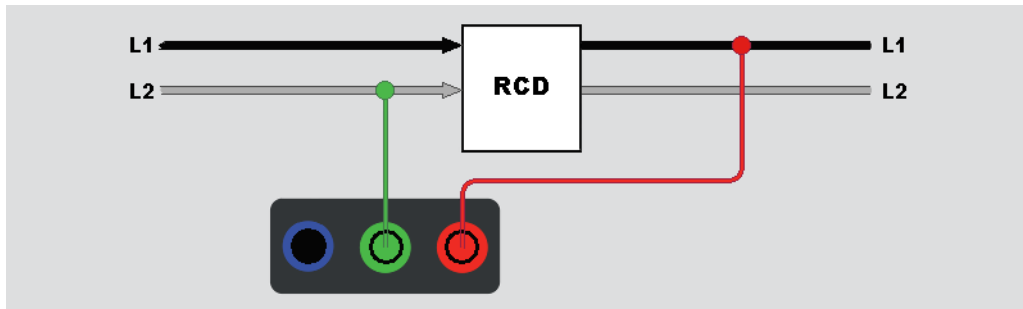

To test RCD type B or RCD type A-EV in an IT system, use the connections shown in [Figure 18](#).

**Figure 18. Connection for Test of RCD Type B or RCD Type A-EV on IT Electrical Systems**

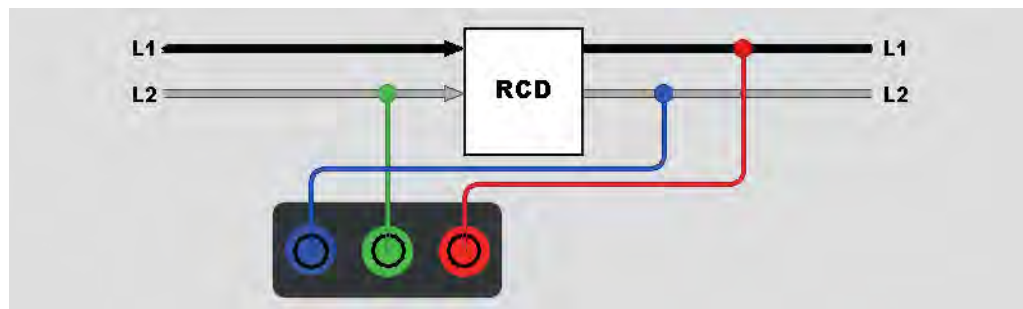

The test current flows through the upper side of the RCD, into the L terminal, and returns through the PE terminal.

To test an RCD at the mains socket, put the Tester into the IT mode. In this mode the Tester accepts any voltage between N and PE. The precondition for trip time and current measurements is that the system capacitance is high enough to allow the test current to flow.

If RCD does not trip, use the test lead configuration shown in [Figure 19](#).

**Figure 19. Single Test Lead Configuration**

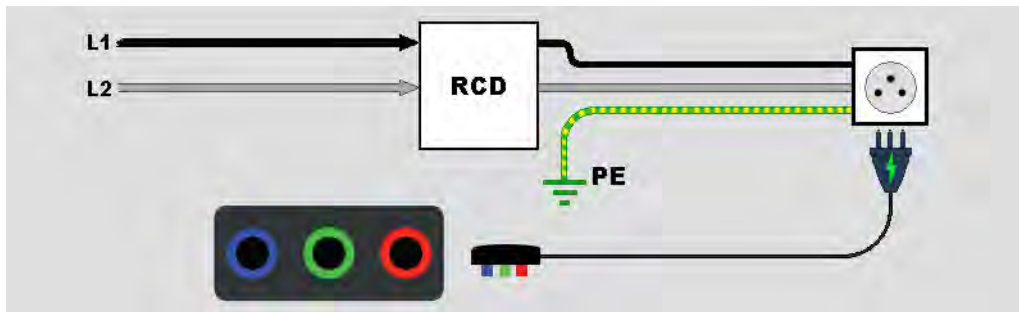



## Phase Rotation Tests

Use the connection shown in [Figure 20](#) for a phase rotation test connection.

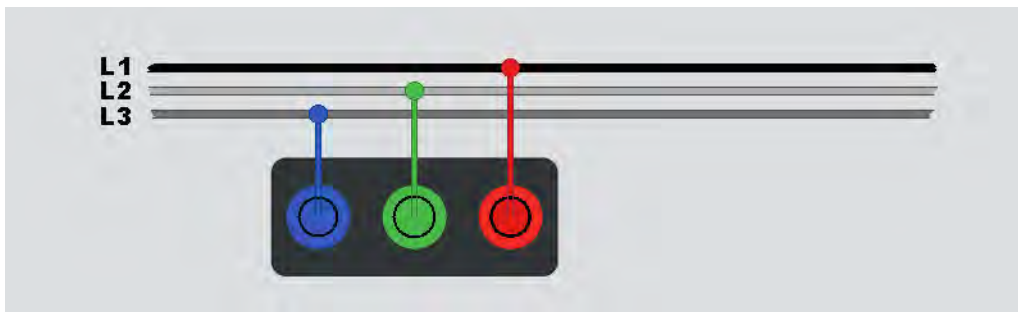
**Figure 20. Phase Rotation Test Connection**



To do a phase rotation test:

1. Select the **Phase** mode.
2. The primary display shows:
  - L1-L2-L3 for correct phase rotation .
  - L3-L2-L1 for reversed phase rotation .
  - **0** when insufficient voltage is sensed.

Tip: Tap  to see the connection diagram and more information on screen.

## Earth Resistance Measurements (1673 FC and 1674 FC)

The earth resistance test is a 3-wire test that has two test stakes and the earth electrode under test. This test requires an accessory stake kit. Connect as shown in [Figure 21](#).

- Best accuracy is achieved with the middle stake at 62 % of the distance to the far stake. The stakes should be in a straight line and wires separated to avoid mutual coupling.
- Disconnect the earth electrode under test from the electrical system as you do the test. Do not measure Earth resistance on a live system.

**Figure 21. Earth Resistance Test Connection**

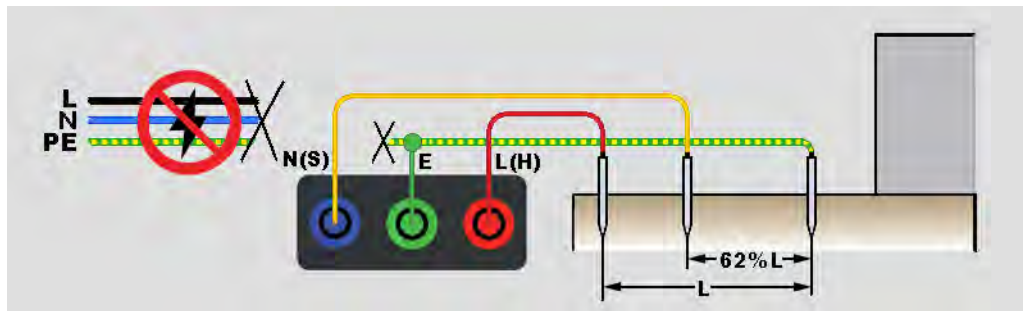

To measure earth resistance:

1. Select the  $R_E$  mode.
2. Press and release **TEST**.
3. Wait for the test to complete:
  - The primary display shows the earth resistance reading.
  - Voltage detected between the test rods shows in the secondary display. If  $>10$  V, the test is inhibited.
  - If the measurement is too noisy, a warning message shows on the display. The measured value accuracy is degraded by the noise.
  - If the probe resistance is too high, a warning message shows on the display. To help reduce probe resistance, push the test stakes further into the earth or apply water to the earth around the test stakes.

This measurement can also be done with a Fluke 1630-2 FC Earth Ground Clamp. A Bluetooth Low Energy (BLE) connection to this clamp is configured in the main menu. When an Earth Ground Clamp is connected, the Tester shows the clamp measurement on the display.

Tip: Tap **i** to see the connection diagram and more information on screen.

## Voltage Drop

Voltage drop is a calculation of the expected voltage drop in volts and a percentage of the value from the reference point (usually the distribution board) at a specific outlet. It is derived from the loop impedance at the point the full maximum allowable current is drawn from that one outlet. The voltage drop is calculated from the loop impedance L-N at an individual outlet and the maximum current.

The voltage measurement consists of two measurements steps. First, a test is done at the distribution board for a reference value. Next, individual outlets are tested. All tests are done in V-drop mode with the same parameter settings and reference value for all connections made through the reference point.

Voltage drop is measured on the line-pair L-N and you select the maximum allowable current from a selection field: 6 / 10 / 16 / 20 / 25 / 32 / 40 A.

To test:

1. Zero the test leads and select the nominal current from the selection field.
2. Measure the reference values at the distribution board.
3. Push **TEST** to start  $Z_{REF}$  measurement.
4. Push **TEST** again for each individual outlet or connection point. See [Figure 22](#).

**Figure 22. Voltage Drop Test Connection**

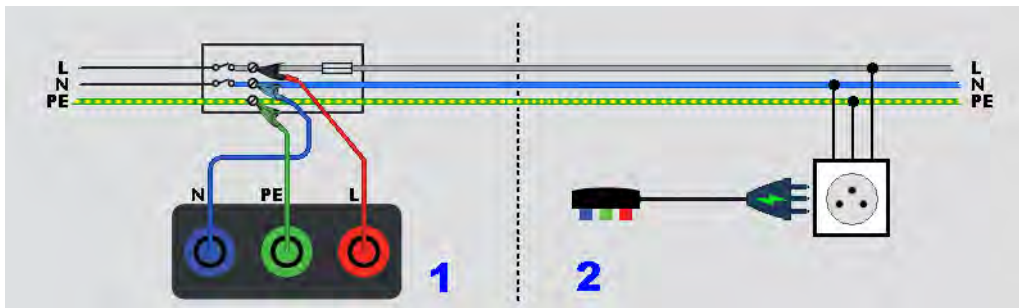



## SPD (1674 FC)

Surge Protection Devices (SPDs) or surge arresters are used to absorb high voltage peaks that surpass any nominal value voltages and potentially harm the installed equipment. At normal voltage levels, the SPDs make up a high impedance, are non-conductive, but at some voltage level (greater than nominal voltage levels) the Tester starts a current draw to make a low impedance. Test voltages can be set at 500 V or 1000 V.

Measuring principle:

A voltage ramp rises in 1 V increments to a pre-set max value of 500 V or 1000 V.

The measurement ends when the pre-set end voltage is reached, or when the device starts to draw a current of 1 mA.

To test:

1. Select the **SPD** mode.
2. Set the voltage range.
3. Push **TEST** to start the SPD measurement test.

The measurement ends when the defined end voltage is reached or if the test current exceeds the value of 1 mA.

4. After the measurement is finished, wait until the device under test is fully discharged.

**Figure 23. SPD Test Connection**

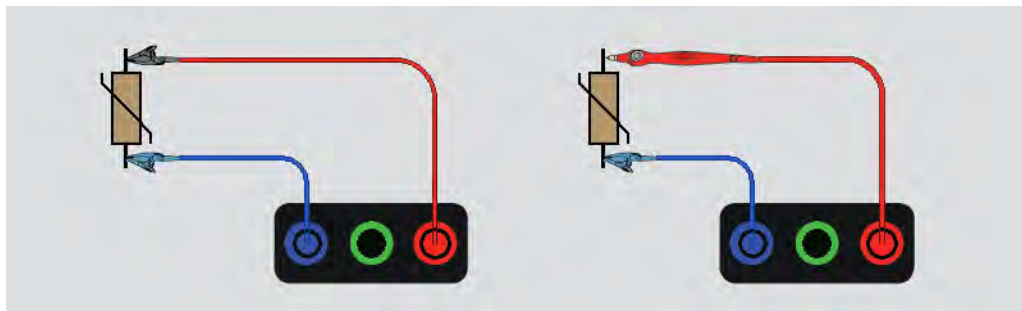

## IMD

Insulation monitoring devices (IMD) continuously monitor the insulation resistance of IT systems (unearthed systems that are meant to have no built-in ground reference) and issue an alarm if the value falls below a response value. To make a measurement, the Tester has to be connected between the IT system and the (local) protective earth conductor (PE). Best practice is to disconnect all appliances from the tested supply to receive normal test results. Any connected appliance will influence the insulation resistance threshold test.

To do an IMD test:

1. Select the **IMD** mode.
2. Select the system response resistance from the table: supported values are 1 k $\Omega$ , 2 k $\Omega$ , 5 k $\Omega$ , 7 k $\Omega$ , 10 k $\Omega$ , 12 k $\Omega$ , 20 k $\Omega$ , 50 k $\Omega$ , 70 k $\Omega$ , 100 k $\Omega$ , 120 k $\Omega$ , 200 k $\Omega$ , and 500 k $\Omega$ .
3. Press **ENTER**.
4. Push **TEST** to start the timer for the IMD measurement.

The stop watch starts.

If the IMD alarm does not indicate a failure:

- a. Select **FAIL** to stop the stop watch.
  - b. Repeat steps 1 and 2 to change the response resistance until the alarm indicates an insulation failure.
5. If the alarm indicates, press the green **PASS** to stop the stop watch.

**Figure 24. IMD Test #1**

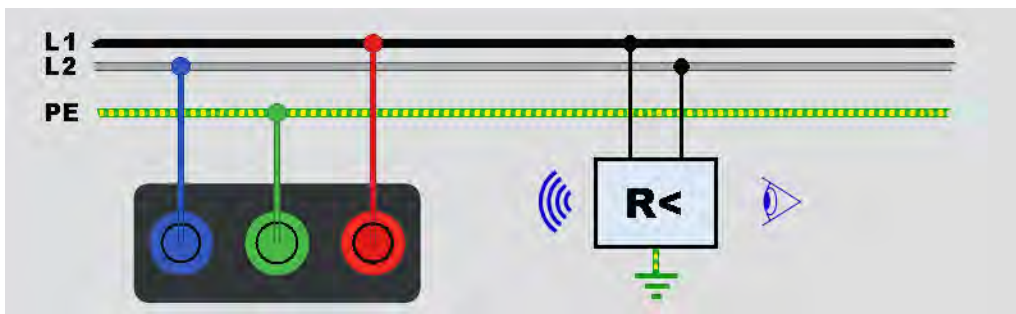

## Applications

This section outlines a few practical setups to make tests faster and more efficient.

### How to Test a Mains Socket and Ring Installation

The mains socket test checks that the mains voltage is present, the frequency is 50 Hz/60 Hz, and the wiring of the mains socket is correct.

For a valid socket test:

- connect all test leads (phase, neutral, and protective earth) to the mains socket
- the mains line cord provides a quick connection to the socket

When a high voltage is measured between two wires, ⚡ shows on the display:

- If the PE wire is live, the  is lit, the PE annunciator in the display is lit, and the beeper sounds.
- If the L and N terminals are reversed, the Tester shows an arrow above the terminal indicator symbol. The Tester automatically reverses these internally and allows the test. When configured for UK operation, the Tester inhibits the test.
- If the L and PE terminals are reversed, the Tester shows an arrow below the terminal indicator symbol and inhibits the test.
- If the N, PE, or installation wire is open or broken, the Tester shows the terminal as a crossed circle. The test can start if the wire is not required for this test.
- If the trip time meets the appropriate standard of the RCD, the **RCD** ✓ indicator shows. For more information, see the *1672/1673 FC/1674 FC Product Specifications* for the RCD Tripping Time table.

## Earth Resistance Test by Loop Method

You can also use the Tester to measure the earth resistance component of the total loop resistance. Check your local regulations to determine if this method is acceptable in your area. You can use three leads or the mains test cord to do this test. Use the connection shown in [Figure 25](#) when you make a 3-wire connection for earth resistance loop test. Zero the test leads before the test. See [How to Zero the Test Leads](#).

**Figure 25. 3-Wire Connection for Earth Resistance Loop Test (No Trip Mode)**

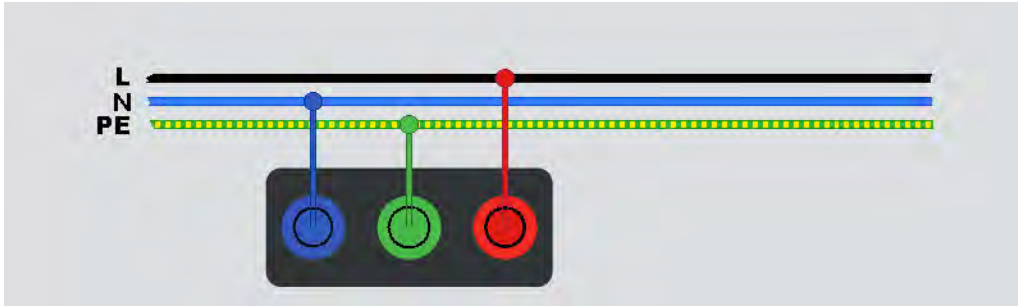

If necessary to meet local regulations, you can measure the earth resistance with the high-current trip mode. See [Trip Mode \(High Current\)](#). Any RCD will trip during this test. The test result will include the resistance of the phase wire and this might be neglected for higher RE resistances. Use the connection shown in [Figure 26](#) when you make a 2-wire connection for earth resistance loop test.

**Figure 26. 2-Wire Connection for Earth Resistance Loop Test (High-Current Trip Mode)**

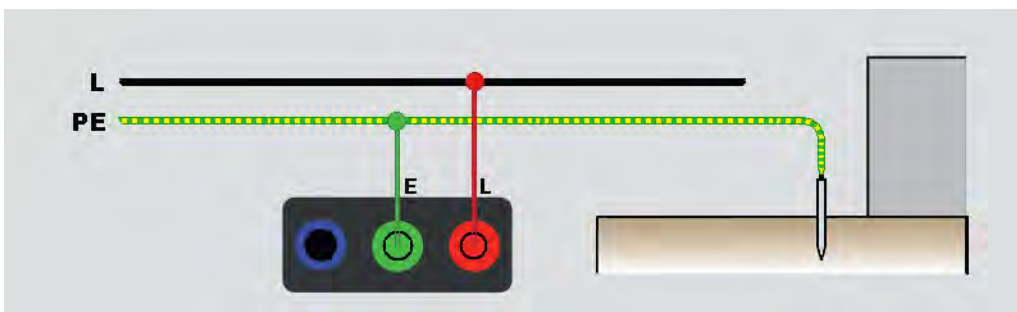

## Zmax

Zmax compares multiple line/loop impedances and retains the maximum impedance. Sockets on a circuit can be tested consecutively and the maximum impedance value retained and stored to memory.

Zmax has a toggle on/off switch. There are two types of Zmax values: Zmax (L-PE) and Z<sub>L</sub> Zmax (L-N). The input selection determines which Zmax value is in use:

- Z<sub>L</sub> No Trip
  - L-N: Z<sub>L</sub> Zmax is in use
  - L-PE: both Z<sub>L</sub> Zmax and Zmax are in use
- Z<sub>L</sub> Trip (Hi Current)
  - L-N: Z<sub>L</sub> Zmax is in use
  - L-PE: Zmax is in use

The Zmax values are retained when you switch between Z<sub>L</sub> No Trip and Z<sub>L</sub> Hi Current. Zmax values are saved with the test result to memory.

## Auto Start

Auto Start enables faster testing. When the Tester detects mains voltage in the loop/line or RCD tests, the test starts automatically without pushing .

## Loop Impedance Test with 10 mA RCD

For a Loop impedance measurement in a 10 mA RCD circuit, Fluke recommends the tripping time RCD test. Use a nominal test current of 10 mA and the factor  $\times \frac{1}{2}$  for this test.

If the fault voltage is  $<25$  V or 50 V, dependent on the local requirement, the loop is good. To calculate the loop impedance, divide the fault voltage by 10 mA (Loop impedance = fault voltage  $\times$  100).

## Preset Auto Test (1673 FC/1674 FC)

Auto Test is a sequence of tests set to run automatically in a selected order with one press of **TEST**. You can customize the sequence with measurement settings. The Tester also has three pre-set sequences for the most often used tests.

The results of the auto test sequence show in a table that updates each time a measurement completes. See [Figure 27](#).

If measurements are done one-by-one in an incorrect order, such as a test that requires no voltage while there is still voltage on the line, the test goes to a waiting state for a corrective action. An example is that you need to reset the RCD or apply voltage on the installation.

**Figure 27. Auto Test Sequence Display**

Auto Test>Preset1	
<b>Preset1</b>	<b>RCD Time</b>
	RCD Type AC
	RCD Polarity 180°
<b>Preset2</b>	RCD Current Multiplier x1
	RCD Current 10 mA
<b>Preset3</b>	<b>Insulation Resistance</b>
	Line Select L-N
	Pretest Pretest OFF
<b>Custom1</b>	Test Voltage 50 V
	<b>Insulation Resistance</b>

Preset 1 includes multiple tests:

- Line test (L-N)
- NoTrip Loop test (L-PE)
- RCD test:
  - Ramp test (type A or type AC, 30 mA, 100 mA, 300 mA)or
  - Auto RCD test (type A or type AC, 30 mA, 100 mA)
- Insulation tests:
  - L-PE, 50 V to 1000 V
  - L-N, 50 V to 1000 V
  - N-PE, 50 V to 1000 V

Preset 2 includes multiple live tests:

- Line test (L-N)
- NoTrip Loop test (L-PE)
- RCD test:
  - Ramp test (type A or type AC, 30 mA, 100 mA, 300 mA)
  - or
  - Auto RCD test (type A or type AC, 30 mA, 100 mA)

Preset 3 includes multiple dead tests:

- Insulation tests:
  - L-PE, 50 V to 1000 V
  - L-N, 50 V to 1000 V
  - N-PE, 50 V to 100 V
- Continuity
  - L-PE
  - L-N
  - N-PE

The Tester starts with the Line/Loop test, then it tests the RCD. After the RCD has tripped, it proceeds with insulation tests. The insulation Safety Pretest and the Zmax are always active.

This test sequence is intended to be done at a mains socket with the mains test cord at circuits that are protected by an RCD with a nominal fault current of  $\geq 30$  mA.

#### Note

*The automatic test sequence will trip an RCD. Because an insulation test is part of the sequence, make sure that no appliances are connected to the circuit under test.*

*If the L and N terminals are reversed, the Tester will auto-swap them internally and continue the tests. If the Tester is configured in L-N mode (no auto lead swap), tests are stopped. Icons indicate if L-PE or L-N terminals are reversed.*

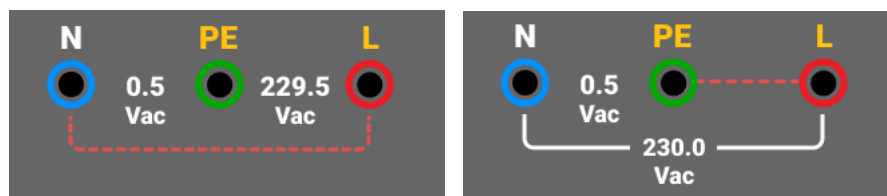

To start an Auto Test:

1. Select the **AUTO TEST** mode.
2. Connect the mains test cord to the Tester.
3. Before you do a loop impedance test, zero the test leads. See [How to Zero the Test Leads](#).
4. Plug the mains test cord into the socket under test.
5. Select the RCD type and test type.
6. Select the nominal RCD fault current.
7. Press and release .

The primary display shows the Loop impedance  $Z_L$  or the Line impedance  $Z_l$ . The secondary display shows the PEFC or the PFC ( $I_k$ ). The RCD will trip and the Tester shows the trip current, and then the trip time. The insulation tests start and you see the results when each test is done. The beeper sounds with each completed test.

*Note*

*You cannot override the Safety Pretest warning because the insulation Safety Pretest is active. If the insulation Safety Pretest detects a connected appliance, the test sequence stops.*

8. When the test is done, reset the RCD.

Test results are in temporary memory. If you want to store the test results for later recall, press

.



## Programmed Autotest Sequence (1674 FC)

The programmable Autotest is a custom automatic test sequence.

With this feature you have the versatility to:

- choose the test order
- pause the test
- restart the test

This allows you to set up the test according to special requirements such as energize, de-energize, or manipulate a circuit before you finish the complete sequence of measurements.

To create or edit a custom Autotest:

1. Push .
2. Select **Auto Test**.
3. Select the custom number you want to save the auto sequence to.

If the custom sequence contains saved tests, the details show on the left side of the display. This area is empty if no tests are assigned.

To add a new test:

1. Select **Add function** and choose the function to add from the pop-up list.
2. Select the settings.
3. Tap  to exit the setup screen.

Repeat these steps to add more tests.

To edit or remove a function:

1. Select the test.
2. Change the settings or select **Remove function**.

## Form Mode

The Tester supports 2-way communication with TruTest software and Fluke Connect to transfer forms and create reports. Standard forms are available by certificate type and include the measurement requirements.

These certificate types are available:

- European Standard IEC/HD 60364-6
- United Kingdom – BS7671, 18<sup>th</sup> Edition
- International Standard

The certificate type is selected when you set the region. See [Localization](#).

The flows that you can set are:

- British standard
- all other standards

Choose the British standard to make the form view in the device look similar to the British standard form.

The device will provide for the user guidance on what measurements should be taken for a specific circuit. An example is when an RCD type with 0.03A with a report NEN-1010 is selected, the test required is an RCD Trip test on 30 mA with all predefined settings according to the standard.

The certificate itself will be created by TruTest software by forwarding the measured results to the application. The files can be transferred using the USB cable. See [Download Test Results](#).

## Create a Form

The form is setup from a Project or as a structured hierarchy that allows you to filter the contents by client and site.

The form is always structured with this hierarchy:

1. Client
2. Client contains Sites

3. Sites contain Project

*Note*

*You can create a Project without a Client or Sites. When you transfer this type of Project to the TruTest software, manual data entry is required for the Client and Sites information.*

4. Project contains the installation data that includes the distribution board, circuits, and test points.

*Note*

*You can use metadata to create the distribution board and circuits and use this data to calculate the test limit.*

## Create Client, Sites, and Projects

To open a Form:

1. Push .
2. On the display, tap .
3. Select **Add Project**.
4. Select **Client** or **Project**.
5. Select **Add+**.

### Client

To add client information:

1. Enter Client information.  
Client code and Name are mandatory fields (\*).
2. Tap **Accept**.

### Site

To add site information:

1. Select **Client**.
2. Select **Add+**.
3. Enter Site information. Site code and name are mandatory fields (\*).
4. Tap **Accept**.

## Project

To add project information:

1. Select **Site**.
2. Enter project code and name.
3. Select **Accept**.

## Distribution Board

To add distribution board information:

1. Select Project.
2. Select **Add+**.
3. Enter Distribution Board information. DB code, Name, and mandatory fields (\*).
4. Select **Accept**.

## Circuits

To add circuit information:

1. Select **Distribution Board**.
2. Select **Add+**.
3. Enter Circuit information. Circuit code and Name are mandatory fields (\*).
4. Select **Accept**.

## Test Points

To add test point information:

1. Select **Circuit**.
2. Select **Add+**.
3. Enter **Test Point** information. Test Point code and Name are mandatory fields (\*).
4. Select **Accept**.
5. Select **Save project**.

### *Note*

*After you enter all the installation information, you must select **Save Project**.*

## Select Project Form

To select a Project Form:

1. Push .

Projects are in a list on the left side of the display with more details on the right side of the display.

2. Select the Project.

The Project name, code, client, and site information show on the left side of the display.

3. Tap on the Project to open the Project Form screen.

## How to Test from a Form

To navigate the Form screen, use the touchscreen or rotary dial. when using the rotary dial press the dial to select a cell or change direction. The Distribution Boards, Circuits, and Test Points for the installation are selected with the tabs in the bottom left of the screen. See [Figure 28](#).

Figure 28. Form

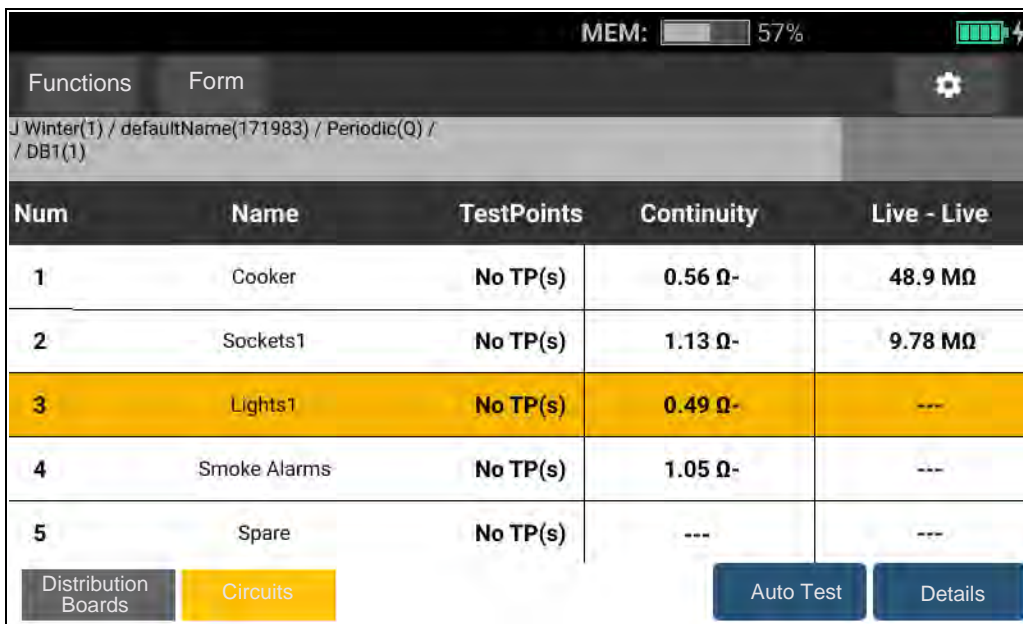

The screenshot shows a mobile application interface for 'Form Mode'. At the top, there's a status bar with 'MEM: 57%' and a battery icon. Below that, a navigation bar has 'Functions' and 'Form' tabs, with a settings gear icon on the right. A breadcrumb trail reads 'J Winter(1) / defaultName(171983) / Periodic(Q) / DB1(1)'. The main content is a table with 5 rows and 5 columns: 'Num', 'Name', 'TestPoints', 'Continuity', and 'Live - Live'. Row 3 is highlighted in yellow. At the bottom, there are tabs for 'Distribution Boards', 'Circuits', and 'Auto Test', and a 'Details' button.

Num	Name	TestPoints	Continuity	Live - Live
1	Cooker	No TP(s)	0.56 Ω-	48.9 MΩ
2	Sockets1	No TP(s)	1.13 Ω-	9.78 MΩ
3	Lights1	No TP(s)	0.49 Ω-	---
4	Smoke Alarms	No TP(s)	1.05 Ω-	---
5	Spare	No TP(s)	---	---

When selected, the screen shows the nodes number, name, and the number of circuits or test points it contains. As you navigate the tabs for Distribution Boards, Circuits, and Test Points, the options in the bottom left of the screen are active.

## Autotest/Edit/Details

**Autotest.** When Distribution Boards, Circuits, or Test Point is selected, you can initiate an automatic test sequence and the measurements automatically transfer to the selected test points when you save the test.

**Edit.** Allows you to edit or delete the selected test point.



**Details.** Shows metadata for the selected point and the options to add a note to the test point or delete the test point.

### Note

*The display header indicates information about the client, site, and project selection.*

## Review a Measurement

To review a measurement:

1. Tap  to open the **System Settings** Menu.
2. Tap **QuickSave Overview**.
3. Swipe on the horizontal and vertical scroll bars to view all available files.
4. Tap on the file icon to view the measurement summary.
5. Tap  to go back to the overview page.

## Clear Memory

To clear memory:

1. Press  to open the Main Menu.
2. Go to **Device Settings > System Settings > Memory Management**.

The Testers show a list of options:

- Remove all projects
  - Remove all clients
  - Remove all custom autotests
  - Factory Reset
3. Tap the option.

A pop-up message asks you to confirm or cancel.

## Download Test Results

To download test results:

1. Connect the USB-C cable to the USB-port on the PC and the USB-C connector on the Tester. See [Figure 29](#).

**Figure 29. USB-C Cable Attachment**

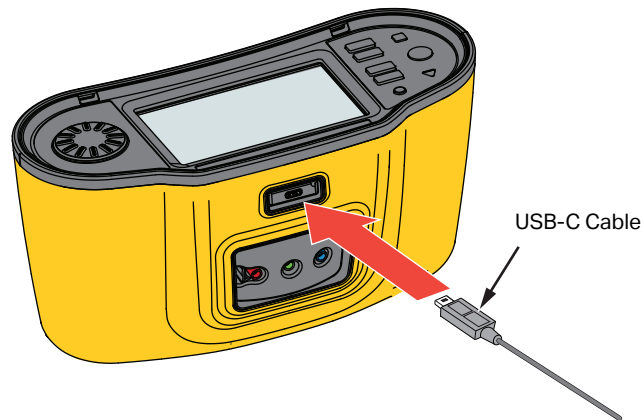

2. Start the TruTest™ Data Management Software.
3. Press  to turn on the Tester.
4. See the software documentation for complete instructions on how to set the date/time stamp and upload data from the Tester.

### Note

*The 1673 FC/1674 FC allows you to upload data wirelessly to a smartphone with the Fluke Connect™ app, share data with others, and e-mail the data to your office. See [Fluke Connect™ Wireless System](#) for more information.*



## Fluke Connect™ Wireless System

The 1673 FC and 1674 FC supports the Fluke Connect™ Wireless System (may not be available in all regions). Fluke Connect is a system that wirelessly connects your Fluke test tools with an app on your smartphone. It enables you to see test results from your Tester on your smartphone screen and share these results with your team.

You can also download the saved test results to a smartphone and send the data package by email.

The Fluke Connect app works with the iPhone and Android Phone. The app is available for download from the Apple App Store and Google Play.

How to access Fluke Connect:

1. Push  on the Tester. The display shows .
2. On your smartphone, enable Bluetooth.
3. Go to the Fluke Connect app and select your model from the list.

You will see the Tester screen on your smartphone. When the Tester is connected to the app,  shows on the Tester display with the green checkmark.

4. To turn off the wireless system on your Tester, press  for >1 second.  disappears.

Go to [www.flukeconnect.com](http://www.flukeconnect.com) for more information about how to use the app.

## TruTest™ Data Management Software

*TruTest™ Data Management Software* is software to manage electrical system test data. This optional software supports data from Fluke DMS software or from Beha-Amprobe ES Control software and automatically converts these databases. You can also use the software for instrument management. For more information, see the *TruTest™ Data Management Software Users Manual*.

For information about how to purchase *TruTest™ Data Management Software*, go to our website: [www.fluke.com](http://www.fluke.com).



## Firmware Updates

Firmware updates are available via the Fluke website. We recommend visiting the website periodically to check for updates particularly when first purchasing you device.

To update:

1. Go to <https://www.fluke.com/en-us/support/software-downloads>.
2. Navigate to the 167x series page.
3. Download the update.
4. Transfer the file to a USB-C stick (USB stick must be formatted as FAT32/NTFS that supports up to 32GB devices).
5. Make sure the Product has at least 50 % battery power available.
6. Make sure you download all the logged data before you update the firmware.
7. Place the USB-C stick in the Tester.
8. Follow on-screen instructions.

### Note

*Depending on the update, a firmware update may require several reboots and take up to 30 minutes. Make sure you allow enough time before you begin the update and wait until the Tester completely restarts.*

## Maintenance

Periodically wipe the case with a damp cloth and mild detergent. Do not use abrasives or solvents. Dirt or moisture in the terminals can affect readings.

### Warning

**To prevent possible electrical shock, fire, or personal injury:**

- **Repair the Product before use if the battery leaks.**
- **Have an approved technician repair the Product.**
- **Use only specified replacement parts.**
- **Replace a blown fuse with exact replacement only for continued protection against arc flash.**
- **Do not operate the Product with covers removed or the case open. Hazardous voltage exposure is possible.**
- **Remove the input signals before you clean the Product.**

To clean the terminals:

1. Turn off the Tester and remove all test leads.
2. Shake out any dirt that may be in the terminals.
3. Moisten a clean cotton swab with alcohol and clean the inside of each terminal.

Table 9 is a list of replaceable parts for the Tester.

**Table 9. Replacement Parts**

Description	Part Number
⚠ Fuse, Time Delay, 3 A, 600 V ac, Class CC, 20 kA Breaking, Ceramic, Cylindrical, 10 mm x 38 mm	6015400
BP290 Li-ion Battery Pack, 10.8 V	4025762

## Battery Condition

The Tester continuously monitors the condition of the battery and shows the status on the display. See [Status](#).

To view information about the battery condition:

1. Push .
2. Select **Device Settings**.
3. Select **Info**.
4. Select **Battery Info**.

The Battery Info page opens to show the details of the battery and condition.

5. Tap  to exit the page and go back to the Main menu.

## Battery Replacement

### **Warning**

**To prevent possible electrical shock, fire, or personal injury:**

- **Do not short the battery terminals together.**
- **Do not disassemble or crush battery cells and battery packs.**
- **Do not put battery cells and battery packs near heat or fire. Do not put in sunlight.**
- **Use only the Fluke BP290 or Fluke-recommended equivalent for replacement.**

### **Caution**

**Replace the rechargeable battery after 5 years.**

The Product has a rechargeable Lithium-ion battery pack.

To replace the battery (see [Figure 30](#)):

1. Press **⏻** to turn off the Tester.
2. Remove the test leads from the terminals.
3. Use a flat-blade screwdriver to turn the battery door screws (3) one-quarter turn counterclockwise.
4. Lift up and remove the battery door.
5. Press the release latch and slide the battery out of the Tester.
6. Replace the battery.
7. Replace the battery door.
8. Turn the battery door screws one-quarter turn clockwise to fasten the door.

**Figure 30. Battery Replacement**

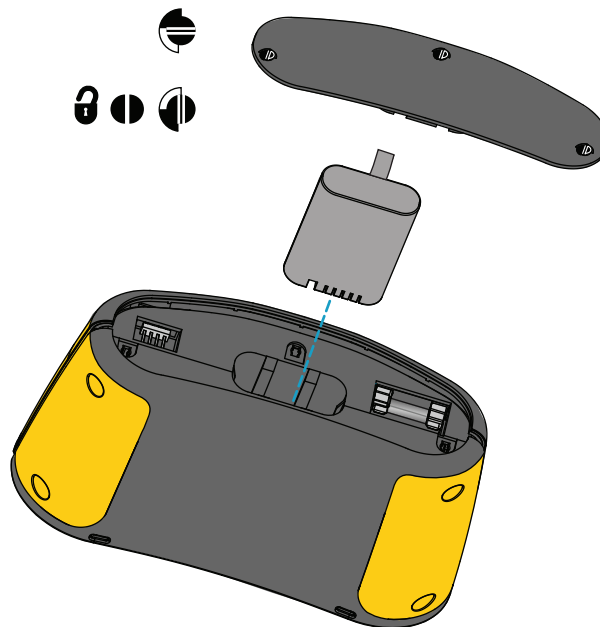

## **Product Disposal**

Dispose of the Product in a professional and environmentally sound manner:

- Delete personal data on the Product before disposal.
- Remove batteries that are not integrated into the electrical system before disposal and dispose of batteries separately.
- If this Product has an integral battery, put the entire Product in the electrical waste.